



# 2025-1 Fiyat Listesi

# Promex

Güvenilir, kolay ve hızlı bağlantılar için...



YENİ NESİL

**PUSH-IN**  
RAY KLEMENSLER



- Güvenli ve düzenli bağlantı sağlar.
- Titreşimlere dayanıklı tasarımlar sunar.
- Kablo yönetimini kolaylaştırır ve bakım süresini kısaltır.



**VIDALI**  
RAY KLEMENSLER



# içindekiler

## şalt grubu

<b>YENİ</b> Araç Şarjları, Akü Takviye ve Taşınabilir Şişirme Pompası	2
<b>YENİ</b> Şalt Ürünleri	4

## anahtar priz grubu

Modüler Sistem	27
Rita Serisi	34
Elitra Plus Serisi	39
Candela Serisi	44
Bella Serisi	50
Nora Serisi	52
Bron Serisi	54
Grup priz ve Aksesuarlar	56

## kablo kanalları, plastik, tesisat ve aydınlatma grubu

Canalex serisi kapalı tip kablo kanalları	64
Eko serisi kapalı tip kablo kanalları	64
Yapışkan bantlı kapalı tip kablo kanalları	64
Meks serisi kapalı tip kablo kanalları	65
Meks serisi klima kanalı ve aksesuarları	65
Tavan köşe ve süpürgelik kablo kanalları	65
Fugalı ve tezgah süpürgeliği	65
Balık sırtı zemin kanalları	65
H.Free Flaret kanal ve aksesuarları	66
Kanal aksesuarları	67
Meks plus serisi için priz setleri	69
Kanal için ups ve enerji prizleri 45x45	70
Sidem serisi renkli kablo kanalları	73
Sidem serisi süpürgelikler ve aksesuarları	73
Comfort W otomat kutuları	77
Comfort zayıf akım kutuları	77
Meksbox W otomat kutuları	78
H. Free spiraller	79
Plastik spiraller	80
Hdpe koruge borular	80
Rögar kutuları	80
Eko serisi çelik ve izole kaplı spiraller	81
Meks serisi çelik ve izole kaplı spiraller	81
Pvc boy borular	83
Fiber kılavuz, çelik susta ve plastik sustalar	83
H.Free borular	84
PVC Boru aksesuarlar	85
Eko Serisi borular	86
Kalın boy boru ve dirsek-muflar	87
Polietilen yeraltı boruları	87
Kasa, buat ve kapakları	88
Buatlar, galvaniz sac kroşeler	89
Çivili kroşeler, dübelller	90
Elektrik izolasyon bandı	91

Kapı zilleri, butonları ve trafoları	92
Kapı otomatiği ve telefon dağıtım kutuları	94
Ledli flaşör lambaları ve motorlu sirenler	94
ME-FAN aspiratörler	95
Mutlusan aspiratörler	96
<b>YENİ</b> Aydınlatmalı tavan vantilatörü	97
Exit - acil aydınlatma armatürleri	98
Led armatür ve armatür çeşitleri	99
<b>YENİ</b> Aplikler	103
<b>YENİ</b> Solar bahçe aplikleri	105
Bahçe armatürleri	106

## pano ve endüstriyel ürün grubu

Promex delikli kanallar	110
Delikli kablo kanalları	112
<b>YENİ</b> Meksplus Abs Panolar	113
Promex Abs panoları ve otomat panoları	114
Abs pano aksesuarları	116
Pano prizleri	117
Higrostat ve termostatlar	118
Promex ve eko fan tepe fanları	119
Filtreli fanlar ve pano ısıtıcıları	120
<b>YENİ</b> Promex Ray Klemens ve Aksesuarları	124
<b>YENİ</b> Alev yaymayan sıra klemensler	131
Geçmeli ve tırnaklı tip buat klemensler	132
Dağıtım üniteleri	133
UV Kablo bağları, Mutlusan kablo bağları, yapışkan kroşeler	134
Kablo toplama & pano spiralleri, kablo omurga kanalları	136
R-Meks plastik kablo rakorları	137
Promex plastik kablo rakoru	138
Polyamid spiral rakorları	140
Yüksükler	142
Baralar, raylar ve topraklama çubuğu	149
Skp çeşitleri	150
<b>YENİ</b> Cee norm fiş ve prizler	151
Sanayi tipi kauçuk fiş ve prizleri	152
Termoplastik buatlar ve kombinasyon kutuları	156
Kombinasyon panoları	158
Kumanda ve vinç kutuları	159
Butonlar ve potansiyometre	161
Ampermetre ve voltmetre	163
İkaz lambaları ve sirenler	168

Mutlusan  
CHARGEBOX

YENİ



Senin Enerjin  
Senin Mutluluğun...



Chargebox V EV Charge



yakında...

10.000  
mAh

ÇOK FONKSİYONLU  
AKÜ TAKVİYE CİHAZI

YENİ



- Akıllı Akü Takviyesi
- Dijital Şişirme Pompası
- Acil Aydınlatma Işıkları
- Kamp Cihazları Şarjı
- Mobil Cihaz Şarjı

Ürün Kodu	Ürün Adı	Adet	Fiyat (₺)
999 999 530001	ÇOK FONKSİYONLU AKÜ TAKVİYE CİHAZI	1	8.356,75

3.500  
mAh

TAŞINABİLİR  
AKILLI ŞİŞİRME POMPASI

YENİ



- Dijital Şişirme Pompası
- Acil Aydınlatma Işıkları
- Kamp Cihazları Şarjı
- Mobil Cihaz Şarjı

Ürün Kodu	Ürün Adı	Adet	Fiyat (₺)
999 999 530002	TAŞINABİLİR AKILLI ŞİŞİRME POMPASI	1	3.633,37

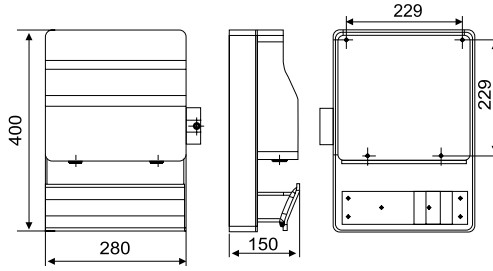

## ARAÇ ŞARJ CİHAZLARI

Ürün Kodu	Ürün Adı	Kutu Adedi	Fiyat (\$)
<b>22 kW ARAÇ ŞARJ CİHAZLARI</b>			
001 191 022001 00 00	MUTLUSAN CHARGEBOX 22 KW EV CHARGER - SOKETLİ	1	1.800 \$
001 191 022002 00 00	MUTLUSAN CHARGEBOX 22 KW EV CHARGER - KABLOLU	1	2.050 \$
001 191 022011 00 00	MUTLUSAN CHARGEBOX 22 KW RFID EKLENTİLİ EV CHARGER - SOKETLİ	1	2.000 \$
001 191 022012 00 00	MUTLUSAN CHARGEBOX 22 KW RFID EKLENTİLİ EV CHARGE - KABLOLU	1	2.250 \$
001 191 000054 00 00	MUTLUSAN CHARGEBOX STAND	1	525 \$

Ürün Kodu	Ürün Adı	Kutu Adedi	Fiyat (₺)
<b>7 kW ARAÇ ŞARJ CİHAZLARI</b>			
001 191 070001 00 00	MUTLUSAN CHARGEBOX 7 KW EV CHARGER - SOKETLİ	1	1.550 \$
001 191 070002 00 00	MUTLUSAN CHARGEBOX 7 KW EV CHARGER - KABLOLU	1	1.750 \$
001 191 070011 00 00	MUTLUSAN CHARGEBOX 7 KW RFID EKLENTİLİ EV CHARGER - SOKETLİ	1	1.750 \$
001 191 070012 00 00	MUTLUSAN CHARGEBOX 7 KW RFID EKLENTİLİ EV CHARGER- KABLOLU	1	1.950 \$

Ürün Kodu	Ürün Adı	Kutu Adedi	Fiyat (₺)
<b>3,5 kW ARAÇ ŞARJ CİHAZI - TAŞINABİLİR</b>			
001 191 030000 00 00	MUTLUSAN CHARGEBOX 3.5 KW TAŞINABİLİR - TAŞINABİLİR	1	850 \$

Ürün Kodu	Ürün Adı	Kutu Adedi	Fiyat (₺)
<b>ŞARJ CİHAZI KABLOLU FİŞLER (5 MT)</b>			
999 983 000010	MUTLUSAN CHARGEBOX 7 KW ÇİFT TARAFLI KABLOLU FİŞ	1	790 \$
999 983 000012	MUTLUSAN CHARGEBOX 22 KW ÇİFT TARAFLI KABLOLU FİŞ	1	940 \$
999 983 000064	MUTLUSAN CHARGEBOX 7 KW ÇİFT TARAFLI KABLOLU FİŞ - SİRALLİ	1	640 \$
999 983 000066	MUTLUSAN CHARGEBOX 22 KW ÇİFT TARAFLI KABLOLU FİŞ - SİRALLİ	1	790 \$

Ürün Kodu	Ürün Adı	Kutu Adedi	Fiyat (₺)
<b>RFID KART</b>			
999 983 000050	MUTLUSAN CHARGEBOX RFID KART	1	20,65 \$



# ŞALT GRUBU



## B - C - D TIPI OTOMATİK SİGORTALAR - 6kA (MCB)



### MTS-6 SERİSİ

Kutup Sayısı	In (A) Anma Akımı	B Tipi Ürün Kodu	C Tipi Ürün Kodu	D Tipi Ürün Kodu	Kutu Adedi	Koli Adedi	Fiyat (\$)
1P	1A	MTS06-1001B	MTS06-1001C	MTS06-1001D	12	240	5,12 \$
	2A	MTS06-1002B	MTS06-1002C	MTS06-1002D	12	240	5,12 \$
	3A	MTS06-1003B	MTS06-1003C	MTS06-1003D	12	240	5,12 \$
	4A	MTS06-1004B	MTS06-1004C	MTS06-1004D	12	240	5,12 \$
	5A	MTS06-1005B	MTS06-1005C	MTS06-1005D	12	240	5,12 \$
	6A	MTS06-1006B	MTS06-1006C	MTS06-1006D	12	240	4,31 \$
	10A	MTS06-1010B	MTS06-1010C	MTS06-1010D	12	240	3,62 \$
	16A	MTS06-1016B	MTS06-1016C	MTS06-1016D	12	240	3,62 \$
	20A	MTS06-1020B	MTS06-1020C	MTS06-1020D	12	240	3,62 \$
	25A	MTS06-1025B	MTS06-1025C	MTS06-1025D	12	240	3,62 \$
	32A	MTS06-1032B	MTS06-1032C	MTS06-1032D	12	240	4,42 \$
	40A	MTS06-1040B	MTS06-1040C	MTS06-1040D	12	240	5,17 \$
	50A	MTS06-1050B	MTS06-1050C	MTS06-1050D	12	240	5,55 \$
63A	MTS06-1063B	MTS06-1063C	MTS06-1063D	12	240	5,85 \$	
2P	1A	MTS06-2001B	MTS06-2001C	MTS06-2001D	6	120	12,31 \$
	2A	MTS06-2002B	MTS06-2002C	MTS06-2002D	6	120	12,31 \$
	3A	MTS06-2003B	MTS06-2003C	MTS06-2003D	6	120	12,31 \$
	4A	MTS06-2004B	MTS06-2004C	MTS06-2004D	6	120	12,31 \$
	5A	MTS06-2005B	MTS06-2005C	MTS06-2005D	6	120	12,31 \$
	6A	MTS06-2006B	MTS06-2006C	MTS06-2006D	6	120	9,62 \$
	10A	MTS06-2010B	MTS06-2010C	MTS06-2010D	6	120	9,62 \$
	16A	MTS06-2016B	MTS06-2016C	MTS06-2016D	6	120	9,62 \$
	20A	MTS06-2020B	MTS06-2020C	MTS06-2020D	6	120	9,62 \$
	25A	MTS06-2025B	MTS06-2025C	MTS06-2025D	6	120	9,62 \$
	32A	MTS06-2032B	MTS06-2032C	MTS06-2032D	6	120	11,54 \$
	40A	MTS06-2040B	MTS06-2040C	MTS06-2040D	6	120	12,50 \$
	50A	MTS06-2050B	MTS06-2050C	MTS06-2050D	6	120	13,46 \$
63A	MTS06-2063B	MTS06-2063C	MTS06-2063D	6	120	13,85 \$	
3P	1A	MTS06-3001B	MTS06-3001C	MTS06-3001D	4	80	15,00 \$
	2A	MTS06-3002B	MTS06-3002C	MTS06-3002D	4	80	15,00 \$
	3A	MTS06-3003B	MTS06-3003C	MTS06-3003D	4	80	15,00 \$
	4A	MTS06-3004B	MTS06-3004C	MTS06-3004D	4	80	15,00 \$
	5A	MTS06-3005B	MTS06-3005C	MTS06-3005D	4	80	15,00 \$
	6A	MTS06-3006B	MTS06-3006C	MTS06-3006D	4	80	12,69 \$
	10A	MTS06-3010B	MTS06-3010C	MTS06-3010D	4	80	12,31 \$
	16A	MTS06-3016B	MTS06-3016C	MTS06-3016D	4	80	12,31 \$
	20A	MTS06-3020B	MTS06-3020C	MTS06-3020D	4	80	12,31 \$
	25A	MTS06-3025B	MTS06-3025C	MTS06-3025D	4	80	12,31 \$
	32A	MTS06-3032B	MTS06-3032C	MTS06-3032D	4	80	13,46 \$
	40A	MTS06-3040B	MTS06-3040C	MTS06-3040D	4	80	13,46 \$
	50A	MTS06-3050B	MTS06-3050C	MTS06-3050D	4	80	14,62 \$
63A	MTS06-3063B	MTS06-3063C	MTS06-3063D	4	80	19,23 \$	
4P	1A	MTS06-4001B	MTS06-4001C	MTS06-4001D	3	60	26,54 \$
	2A	MTS06-4002B	MTS06-4002C	MTS06-4002D	3	60	26,54 \$
	3A	MTS06-4003B	MTS06-4003C	MTS06-4003D	3	60	26,54 \$
	4A	MTS06-4004B	MTS06-4004C	MTS06-4004D	3	60	26,54 \$
	5A	MTS06-4005B	MTS06-4005C	MTS06-4005D	3	60	26,54 \$
	6A	MTS06-4006B	MTS06-4006C	MTS06-4006D	3	60	23,08 \$
	10A	MTS06-4010B	MTS06-4010C	MTS06-4010D	3	60	19,62 \$
	16A	MTS06-4016B	MTS06-4016C	MTS06-4016D	3	60	19,62 \$
	20A	MTS06-4020B	MTS06-4020C	MTS06-4020D	3	60	19,62 \$
	25A	MTS06-4025B	MTS06-4025C	MTS06-4025D	3	60	19,62 \$
	32A	MTS06-4032B	MTS06-4032C	MTS06-4032D	3	60	21,15 \$
	40A	MTS06-4040B	MTS06-4040C	MTS06-4040D	3	60	21,15 \$
	50A	MTS06-4050B	MTS06-4050C	MTS06-4050D	3	60	26,15 \$
63A	MTS06-4063B	MTS06-4063C	MTS06-4063D	3	60	26,92 \$	





## C TİPİ OTOMATİK SİGORTALAR - 10kA (MCB)

### MTS-10 SERİSİ

ŞALT GRUBU



Kutup Sayısı	In (A) Anma Akımı	Ürün Kodu	Kutu Adedi	Koli Adedi	Fiyat (\$)
1P	1A	MTS10-1001C	12	240	8,62 \$
	2A	MTS10-1002C	12	240	8,62 \$
	3A	MTS10-1003C	12	240	8,62 \$
	4A	MTS10-1004C	12	240	8,62 \$
	5A	MTS10-1005C	12	240	8,62 \$
	6A	MTS10-1006C	12	240	7,03 \$
	10A	MTS10-1010C	12	240	6,52 \$
	16A	MTS10-1016C	12	240	6,52 \$
	20A	MTS10-1020C	12	240	6,52 \$
	25A	MTS10-1025C	12	240	6,52 \$
	32A	MTS10-1032C	12	240	6,69 \$
	40A	MTS10-1040C	12	240	7,62 \$
	50A	MTS10-1050C	12	240	7,93 \$
	63A	MTS10-1063C	12	240	10,00 \$
	80A	MTS10-1080C	12	240	19,31 \$
100A	MTS10-1100C	12	240	19,97 \$	
125A	MTS10-1125C	12	240	22,90 \$	



2P	1A	MTS10-2001C	6	120	19,23 \$
	2A	MTS10-2002C	6	120	19,23 \$
	3A	MTS10-2003C	6	120	19,23 \$
	4A	MTS10-2004C	6	120	19,23 \$
	5A	MTS10-2005C	6	120	19,23 \$
	6A	MTS10-2006C	6	120	19,23 \$
	10A	MTS10-2010C	6	120	18,15 \$
	16A	MTS10-2016C	6	120	18,15 \$
	20A	MTS10-2020C	6	120	18,15 \$
	25A	MTS10-2025C	6	120	18,15 \$
	32A	MTS10-2032C	6	120	20,19 \$
	40A	MTS10-2040C	6	120	20,38 \$
	50A	MTS10-2050C	6	120	20,38 \$
	63A	MTS10-2063C	6	120	20,77 \$
	80A	MTS10-2080C	6	120	35,59 \$
100A	MTS10-2100C	6	120	38,41 \$	
125A	MTS10-2125C	6	120	42,66 \$	



3P	1A	MTS10-3001C	4	80	28,59 \$
	2A	MTS10-3002C	4	80	28,59 \$
	3A	MTS10-3003C	4	80	28,59 \$
	4A	MTS10-3004C	4	80	28,59 \$
	5A	MTS10-3005C	4	80	28,59 \$
	6A	MTS10-3006C	4	80	23,07 \$
	10A	MTS10-3010C	4	80	20,72 \$
	16A	MTS10-3016C	4	80	20,72 \$
	20A	MTS10-3020C	4	80	20,72 \$
	25A	MTS10-3025C	4	80	22,62 \$
	32A	MTS10-3032C	4	80	23,24 \$
	40A	MTS10-3040C	4	80	25,07 \$
	50A	MTS10-3050C	4	80	25,83 \$
	63A	MTS10-3063C	4	80	32,21 \$
	80A	MTS10-3080C	6	120	68,03 \$
100A	MTS10-3100C	6	120	70,07 \$	
125A	MTS10-3125C	6	120	76,34 \$	



4P	1A	MTS10-4001C	3	60	38,34 \$
	2A	MTS10-4002C	3	60	38,34 \$
	3A	MTS10-4003C	3	60	38,34 \$
	4A	MTS10-4004C	3	60	38,34 \$
	5A	MTS10-4005C	3	60	38,34 \$
	6A	MTS10-4006C	3	60	32,34 \$
	10A	MTS10-4010C	3	60	30,45 \$
	16A	MTS10-4016C	3	60	30,45 \$
	20A	MTS10-4020C	3	60	30,45 \$
	25A	MTS10-4025C	3	60	30,79 \$
	32A	MTS10-4032C	3	60	30,79 \$
	40A	MTS10-4040C	3	60	31,86 \$
	50A	MTS10-4050C	3	60	44,23 \$
	63A	MTS10-4063C	3	60	50,00 \$
	80A	MTS10-4080C	4	80	92,76 \$
100A	MTS10-4100C	4	80	95,93 \$	
125A	MTS10-4125C	4	80	107,69 \$	

## C TİPİ OTOMATİK SİGORTALAR - 10kA (MCB)

Kutup Sayısı	In (A) Anma Akımı	Ürün Kodu	Kutu Adedi	Koli Adedi	Fiyat (\$)
1P	80A	MTH10-1080C	12	120	19,23 \$
	100A	MTH10-1100C	12	120	23,08 \$
	125A	MTH10-1125C	12	120	34,62 \$
2P	80A	MTH10-2080C	6	60	38,46 \$
	100A	MTH10-2100C	6	60	40,38 \$
	125A	MTH10-2125C	6	60	46,15 \$
3P	80A	MTH10-3080C	4	40	65,38 \$
	100A	MTH10-3100C	4	40	69,23 \$
	125A	MTH10-3125C	4	40	76,92 \$
4P	80A	MTH10-4080C	3	30	84,62 \$
	100A	MTH10-4100C	3	30	92,31 \$
	125A	MTH10-4125C	3	30	123,08 \$

CE

MTH SERİSİ

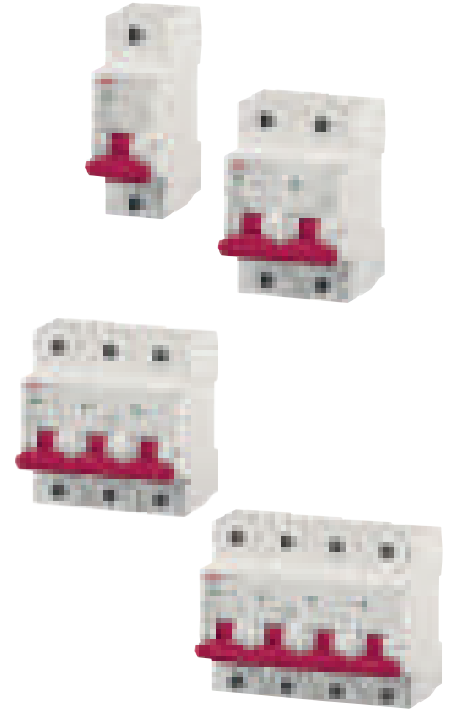

ŞALT GRUBU

## OTOMATİK SİGORTA YARDIMCI KONTAKLARI

Ürün Kodu	Ürün Adı	Kutu Adedi	Koli Adedi	Fiyat (\$)
MTSAUX-AC12	Otomatik Sigorta Yardımcı Kontak 12VAC	20	400	9,83 \$
MTSAUX-230	Otomatik Sigorta Açtırma Bobini	10	540	13,46 \$

## FAZ+NÖTR SİGORTALAR - 4,5kA (DPN+MCB)

Kutup Sayısı	In (A) Anma Akımı	Ürün Kodu	Kutu Adedi	Koli Adedi	Fiyat (\$)
1P+N	6A	MTS04-106CN	12	240	6,00 \$
	10A	MTS04-110CN	12	240	6,00 \$
	16A	MTS04-116CN	12	240	6,00 \$
	20A	MTS04-120CN	12	240	6,00 \$
	25A	MTS04-125CN	12	240	6,00 \$
	32A	MTS04-132CN	12	240	6,60 \$
	40A	MTS04-140CN	12	240	6,60 \$

CE

MTS04-N SERİSİ





## KAÇAK AKIM DEVRE KORUMA 6kA / A / AC (RCCB)

### MRC-2 / MRC-4 SERİSİ

Kutup Sayısı	In (A) Anma Akımı	mA	A Tipi Ürün Kodu	Fiyat (\$)	AC Tipi Ürün Kodu	Kutu Adedi	Koli Adedi	Fiyat (\$)
2P	16A	10 mA	-		MRC06-201016	1	100	26,38 \$
	25A		-		MRC06-201025	1	100	26,90 \$
	16A	30 mA	MRC06-203016A	39,23 \$	MRC06-203016	1	100	26,38 \$
	20A		MRC06-203020A	39,23 \$	MRC06-203020	1	100	26,90 \$
	25A		MRC06-203025A	39,23 \$	MRC06-203025	1	100	26,90 \$
	32A		MRC06-203032A	39,23 \$	MRC06-203032	1	100	27,24 \$
	40A		MRC06-203040A	39,23 \$	MRC06-203040	1	100	27,55 \$
	50A		MRC06-203050A	42,31 \$	MRC06-203050	1	100	29,31 \$
	63A		MRC06-203063A	42,31 \$	MRC06-203063	1	100	29,31 \$
	80A		MRC06-203080A	73,23 \$	MRC06-203080	1	100	40,33 \$
	100A	MRC06-2030100A	73,23 \$	MRC06-2030100	1	100	48,28 \$	
	16A	100 mA	-	-	MRC06-210016	1	100	26,38 \$
	20A		-	-	MRC06-210020	1	100	26,90 \$
	25A		-	-	MRC06-210025	1	100	26,90 \$
	32A		-	-	MRC06-210032	1	100	27,24 \$
	40A		-	-	MRC06-210040	1	100	27,55 \$
	50A		-	-	MRC06-210050	1	100	29,31 \$
	63A		-	-	MRC06-210063	1	100	29,31 \$
80A	-		-	MRC06-210080	1	100	40,33 \$	
100A	-	-	MRC06-2100100	1	100	48,28 \$		
16A	300 mA	MRC06-230016A	39,23 \$	MRC06-230016	1	100	26,45 \$	
20A		MRC06-230020A	39,23 \$	MRC06-230020	1	100	26,45 \$	
25A		MRC06-230025A	39,23 \$	MRC06-230025	1	100	26,45 \$	
32A		MRC06-230032A	39,23 \$	MRC06-230032	1	100	26,45 \$	
40A		MRC06-230040A	39,23 \$	MRC06-230040	1	100	26,45 \$	
50A		MRC06-230050A	42,31 \$	MRC06-230050	1	100	28,90 \$	
63A		MRC06-230063A	42,31 \$	MRC06-230063	1	100	29,38 \$	
80A		MRC06-230080A	55,74 \$	MRC06-230080	1	100	39,62 \$	
100A	MRC06-2300100A	55,74 \$	MRC06-2300100	1	100	44,49 \$		
4P	16A	30 mA	MRC06-403016A	50,77 \$	MRC06-403016	1	50	36,17 \$
	20A		MRC06-403020A	50,77 \$	MRC06-403020	1	50	36,17 \$
	25A		MRC06-403025A	50,77 \$	MRC06-403025	1	50	36,17 \$
	32A		MRC06-403032A	50,77 \$	MRC06-403032	1	50	36,86 \$
	40A		MRC06-403040A	50,77 \$	MRC06-403040	1	50	37,90 \$
	50A		MRC06-403050A	61,54 \$	MRC06-403050	1	50	37,90 \$
	63A		MRC06-403063A	61,54 \$	MRC06-403063	1	50	39,72 \$
	80A		MRC06-403080A	86,96 \$	MRC06-403080	1	50	39,72 \$
	100A	MRC06-4030100A	86,96 \$	MRC06-4030100	1	50	44,83 \$	
	16A	100 mA	-	-	MRC06-410016	1	50	36,17 \$
	20A		-	-	MRC06-410020	1	50	36,17 \$
	25A		-	-	MRC06-410025	1	50	36,17 \$
	32A		-	-	MRC06-410032	1	50	36,86 \$
	40A		-	-	MRC06-410040	1	50	37,90 \$
	50A		-	-	MRC06-410050	1	50	37,90 \$
	63A		-	-	MRC06-410063	1	50	39,72 \$
	80A		-	-	MRC06-410080	1	50	41,21 \$
	100A	-	-	MRC06-4100100	1	50	44,83 \$	
	16A	300 mA	MRC06-430016A	50,77 \$	MRC06-430016	1	50	34,55 \$
	20A		MRC06-430020A	50,77 \$	MRC06-430020	1	50	34,55 \$
	25A		MRC06-430025A	50,77 \$	MRC06-430025	1	50	34,55 \$
	32A		MRC06-430032A	50,77 \$	MRC06-430032	1	50	34,55 \$
	40A		MRC06-430040A	50,77 \$	MRC06-430040	1	50	36,45 \$
	50A		MRC06-430050A	61,54 \$	MRC06-430050	1	50	38,14 \$
63A	MRC06-430063A		61,54 \$	MRC06-430063	1	50	40,38 \$	
80A	MRC06-430080A		86,96 \$	MRC06-430080	1	50	57,67 \$	
100A	MRC06-4300100A	86,96 \$	MRC06-4300100	1	50	64,83 \$		



## KAÇAK AKIM DEVRE KORUMA 10kA / A / AC (RCCB)

Kutup Sayısı	In (A) Anma Akımı	mA	A Tipi Ürün Kodu	AC Tipi Ürün Kodu	Kutu Adedi	Koli Adedi	Fiyat (\$)
2P	16A	30 mA	MRC10-203016A	MRC10-203016	1	100	42,31 \$
	20A		MRC10-203020A	MRC10-203020	1	100	42,31 \$
	25A		MRC10-203025A	MRC10-203025	1	100	42,31 \$
	32A		MRC10-203032A	MRC10-203032	1	100	42,31 \$
	40A		MRC10-203040A	MRC10-203040	1	100	42,31 \$
	50A		MRC10-203050A	MRC10-203050	1	100	42,31 \$
	63A		MRC10-203063A	MRC10-203063	1	100	42,31 \$
	80A		MRC10-203080A	MRC10-203080	1	100	84,62 \$
	100A		MRC10-2030100A	MRC10-2030100	1	100	84,62 \$
	16A	300 mA	MRC10-230016A	MRC10-230016	1	100	42,31 \$
	20A		MRC10-230020A	MRC10-230020	1	100	42,31 \$
	25A		MRC10-230025A	MRC10-230025	1	100	42,31 \$
	32A		MRC10-230032A	MRC10-230032	1	100	42,31 \$
	40A		MRC10-230040A	MRC10-230040	1	100	42,31 \$
	50A		MRC10-230050A	MRC10-230050	1	100	42,31 \$
	63A		MRC10-230063A	MRC10-230063	1	100	42,31 \$
	80A		MRC10-230080A	MRC10-230080	1	100	84,62 \$
	100A		MRC10-2300100A	MRC10-2300100	1	100	84,62 \$
4P	16A	30 mA	MRC10-403016A	MRC10-403016	1	50	65,38 \$
	20A		MRC10-403020A	MRC10-403020	1	50	65,38 \$
	25A		MRC10-403025A	MRC10-403025	1	50	65,38 \$
	32A		MRC10-403032A	MRC10-403032	1	50	65,38 \$
	40A		MRC10-403040A	MRC10-403040	1	50	65,38 \$
	50A		MRC10-403050A	MRC10-403050	1	50	65,38 \$
	63A		MRC10-403063A	MRC10-403063	1	50	65,38 \$
	80A		MRC10-403080A	MRC10-403080	1	50	103,85 \$
	100A		MRC10-4030100A	MRC10-4030100	1	50	103,85 \$
	16A	300 mA	MRC10-430016A	MRC10-430016	1	50	65,38 \$
	20A		MRC10-430020A	MRC10-430020	1	50	65,38 \$
	25A		MRC10-430025A	MRC10-430025	1	50	65,38 \$
	32A		MRC10-430032A	MRC10-430032	1	50	65,38 \$
	40A		MRC10-430040A	MRC10-430040	1	50	65,38 \$
	50A		MRC10-430050A	MRC10-430050	1	50	65,38 \$
	63A		MRC10-430063A	MRC10-430063	1	50	65,38 \$
	80A		MRC10-430080A	MRC10-430080	1	50	103,85 \$
	100A		MRC10-4300100A	MRC10-4300100	1	50	103,85 \$

CE

MRC-10 SERİSİ





## KAÇAK AKIM DEVRE KORUMA - GECİKMELİ - 6kA

### MRC-2 / MRC-4 SERİSİ



Kutup Sayısı	In (A) Anma Akımı	mA	Ürün Tipi	Kutu Adedi	Koli Adedi	Fiyat (\$)	Price (\$)
2P	25A	30 mA	AC Tipi	MRC06-203025G	1	100	41,92 \$
	40A			MRC06-203040G	1	100	41,92 \$
	63A			MRC06-203063G	1	100	41,92 \$
	80A			MRC06-203080G	1	100	53,48 \$
	100A			MRC06-203100G	1	100	53,48 \$
	25A	30 mA	A Tipi	MRC06-203025AG	1	100	51,92 \$
	40A			MRC06-203040AG	1	100	51,92 \$
	63A			MRC06-203063AG	1	100	51,92 \$
	80A			MRC06-203080AG	1	100	64,35 \$
	100A			MRC06-203100AG	1	100	64,35 \$
	25A	300 mA	AC Tipi	MRC06-230025G	1	100	51,92 \$
	40A			MRC06-230040G	1	100	51,92 \$
	63A			MRC06-230063G	1	100	51,92 \$
	80A			MRC06-230080G	1	100	64,35 \$
	100A			MRC06-2300100G	1	100	64,35 \$
	25A	300 mA	A Tipi	MRC06-230025AG	1	100	51,92 \$
40A	MRC06-230040AG			1	100	51,92 \$	
63A	MRC06-230063AG			1	100	51,92 \$	
80A	MRC06-230080AG			1	100	64,35 \$	
100A	MRC06-2300100AG			1	100	64,35 \$	
4P	25A	30 mA	AC Tipi	MRC06-403025G	1	50	76,92 \$
	40A			MRC06-403040G	1	50	76,92 \$
	63A			MRC06-403063G	1	50	76,92 \$
	80A			MRC06-403080G	1	50	84,62 \$
	100A			MRC06-4030100G	1	50	84,62 \$
	25A	30 mA	A Tipi	MRC06-403025AG	1	50	76,92 \$
	40A			MRC06-403040AG	1	50	76,92 \$
	63A			MRC06-403063AG	1	50	76,92 \$
	80A			MRC06-403080AG	1	50	84,62 \$
	100A			MRC06-4030100AG	1	50	84,62 \$
	25A	300 mA	AC Tipi	MRC06-430025G	1	50	65,38 \$
	40A			MRC06-430040G	1	50	65,38 \$
	63A			MRC06-430063G	1	50	65,38 \$
	80A			MRC06-430080G	1	50	80,77 \$
	100A			MRC06-4300100G	1	50	80,77 \$
	25A	300 mA	A Tipi	MRC06-430025AG	1	50	65,38 \$
40A	MRC06-430040AG			1	50	65,38 \$	
63A	MRC06-430063AG			1	50	65,38 \$	
80A	MRC06-430080AG			1	50	80,77 \$	
100A	MRC06-4300100AG			1	50	80,77 \$	

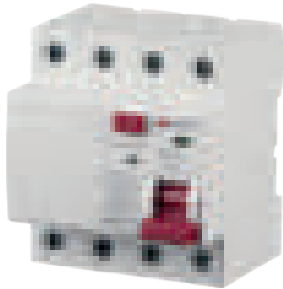

## CE B TİPİ KAÇAK AKIM DEVRE KORUMA - 10kA (RCCB)

### MRC-10 SERİSİ

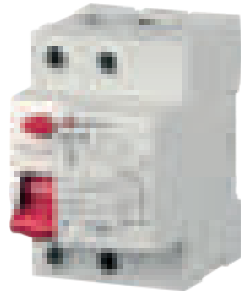

Kutup Sayısı	In (A) Anma Akımı	mA	Ürün Kodu	Kutu Adedi	Koli Adedi	Fiyat (\$)
2P	25A	30 mA	MRC10-203025B	1	100	146,15 \$
	40A		MRC10-203040B	1	100	146,15 \$
	63A		MRC10-203063B	1	100	146,15 \$
	25A	300 mA	MRC10-230025B	1	100	146,15 \$
	40A		MRC10-230040B	1	100	146,15 \$
	63A		MRC10-230063B	1	100	146,15 \$
4P	25A	30 mA	MRC10-403025B	1	50	250,00 \$
	40A		MRC10-403040B	1	50	250,00 \$
	63A		MRC10-403063B	1	50	250,00 \$
	25A	300 mA	MRC10-430025B	1	50	250,00 \$
	40A		MRC10-430040B	1	50	250,00 \$
	63A		MRC10-430063B	1	50	250,00 \$

## KAÇAK AKIM AÇTIRMA ÜNİTESİ - RECLOSER



Ürün Kodu	Ürün Adı	Kutu Adedi	Koli Adedi	Fiyat (\$)
MRC06-RC300	Kaçak Akım Açtırma Ünitesi	1	50	134,62 \$

## KAÇAK AKIM KORUMALI SİGORTALAR - (ELEKTRONİK - KABLOLU) 6kA (RCBO)



### MRE006 SERİSİ

Kutup Sayısı	In (A) Anma Akımı	mA	Tipi	Ürün Kodu	Kutu Adedi	Koli Adedi	Fiyat (\$)
1	6A	10 mA	A Tipi	MRE006-101006A	1	60	61,54 \$
	16A			MRE006-101016A	1	60	61,54 \$
	20A			MRE006-101020A	1	60	61,54 \$
	25A			MRE006-101025A	1	60	61,54 \$
	6A	30 mA	A Tipi	MRE006-103006A	1	60	61,54 \$
	16A			MRE006-103016A	1	60	61,54 \$
	20A			MRE006-103020A	1	60	61,54 \$
	25A			MRE006-103025A	1	60	61,54 \$
	32A			MRE006-103032A	1	60	61,54 \$
	40A			MRE006-103040A	1	60	61,54 \$
	6A	100 mA	A Tipi	MRE006-103063A	1	60	61,54 \$
	6A			MRE006-110006A	1	60	61,54 \$
16A	MRE006-110016A			1	60	61,54 \$	
20A	MRE006-110020A			1	60	61,54 \$	
25A	MRE006-110025A			1	60	61,54 \$	
32A	MRE006-110032A			1	60	61,54 \$	
40A	MRE006-110040A	1	60	61,54 \$			
6A	300 mA	A Tipi	MRE006-110063A	1	60	61,54 \$	
6A			MRE006-130006A	1	60	61,54 \$	
16A			MRE006-130016A	1	60	61,54 \$	
20A			MRE006-130020A	1	60	61,54 \$	
25A			MRE006-130025A	1	60	61,54 \$	
32A			MRE006-130032A	1	60	61,54 \$	
40A	MRE006-130040A	1	60	61,54 \$			
6A	MRE006-130063A	1	60	61,54 \$			



## CE KAÇAK AKIM KORUMALI SİGORTALAR - (ELEKTRONİK) 6kA (RCBO)

### MRE06 SERİSİ

Kutup Sayısı	In (A) Anma Akımı	mA	Tipi	Ürün Kodu	Kutu Adedi	Koli Adedi	Fiyat (\$)
2P	6A	10 mA	AC Tipi	MRE06-201006AC	1	90	38,46 \$
	16A			MRE06-201016AC	1	90	38,46 \$
	20A			MRE06-201020AC	1	90	38,46 \$
	25A			MRE06-201025AC	1	90	38,46 \$
	20A	10 mA	A Tipi	MRE06-201020A	1	90	38,46 \$
	25A			MRE06-201025A	1	90	38,46 \$
	6A	30 mA	AC Tipi	MRE06-203006AC	1	90	38,46 \$
	16A			MRE06-203016AC	1	90	38,46 \$
	20A			MRE06-203020AC	1	90	38,46 \$
	25A			MRE06-203025AC	1	90	38,46 \$
	32A			MRE06-203032AC	1	90	38,46 \$
	40A			MRE06-203040AC	1	90	38,46 \$
	63A			MRE06-203063AC	1	90	38,46 \$
	6A	30 mA	A Tipi	MRE06-203006A	1	90	38,46 \$
	16A			MRE06-203016A	1	90	38,46 \$
	20A			MRE06-203020A	1	90	38,46 \$
	25A			MRE06-203025A	1	90	38,46 \$
	32A			MRE06-203032A	1	90	38,46 \$
	40A			MRE06-203040A	1	90	38,46 \$
	63A			MRE06-203063A	1	90	38,46 \$
	6A	100 mA	AC Tipi	MRE06-210006AC	1	90	38,46 \$
	16A			MRE06-210016AC	1	90	38,46 \$
	20A			MRE06-210020AC	1	90	38,46 \$
	25A			MRE06-210025AC	1	90	38,46 \$
	32A			MRE06-210032AC	1	90	38,46 \$
	40A			MRE06-210040AC	1	90	38,46 \$
	63A			MRE06-210063AC	1	90	38,46 \$
	6A	100 mA	A Tipi	MRE06-210006A	1	90	38,46 \$
16A	MRE06-210016A			1	90	38,46 \$	
20A	MRE06-210020A			1	90	38,46 \$	
25A	MRE06-210025A			1	90	38,46 \$	
32A	MRE06-210032A			1	90	38,46 \$	
40A	MRE06-210040A			1	90	38,46 \$	
63A	MRE06-210063A			1	90	38,46 \$	
6A	300 mA	AC Tipi	MRE06-230006AC	1	90	38,46 \$	
16A			MRE06-230016AC	1	90	38,46 \$	
20A			MRE06-230020AC	1	90	38,46 \$	
25A			MRE06-230025AC	1	90	38,46 \$	
32A			MRE06-230032AC	1	90	38,46 \$	
40A			MRE06-230040AC	1	90	38,46 \$	
63A			MRE06-230063AC	1	90	38,46 \$	
6A	300 mA	A Tipi	MRE06-230006A	1	90	38,46 \$	
16A			MRE06-230016A	1	90	38,46 \$	
20A			MRE06-230020A	1	90	38,46 \$	
25A			MRE06-230025A	1	90	38,46 \$	
32A			MRE06-230032A	1	90	38,46 \$	
40A			MRE06-230040A	1	90	38,46 \$	
63A			MRE06-230063A	1	90	38,46 \$	



## KAÇAK AKIM KORUMALI SİGORTALAR - (ELEKTRONİK) 6kA (RCBO)



### MRE006 SERİSİ

Kutup Sayısı	In (A) Anma Akımı	mA	Tipi	Ürün Kodu	Kutu Adedi	Koli Adedi	Fiyat (\$)
4P	6A	30 mA	AC Tipi	MRE006-403006AC	1	36	63,46 \$
	10A			MRE006-403010AC	1	36	63,46 \$
	16A			MRE006-403016AC	1	36	63,46 \$
	20A			MRE006-403020AC	1	36	63,46 \$
	25A			MRE006-403025AC	1	36	63,46 \$
	32A			MRE006-403032AC	1	36	63,46 \$
	40A			MRE006-403040AC	1	36	63,46 \$
	63A			MRE006-403063AC	1	36	63,46 \$
	6A			30 mA	A Tipi	MRE006-403006A	1
	10A	MRE006-403010A	1			36	63,46 \$
	16A	MRE006-403016A	1			36	63,46 \$
	20A	MRE006-403020A	1			36	63,46 \$
	25A	MRE006-403025A	1			36	63,46 \$
	32A	MRE006-403032A	1			36	63,46 \$
	40A	MRE006-403040A	1			36	63,46 \$
	63A	MRE006-403063A	1			36	63,46 \$
	6A	100 mA	AC Tipi			MRE006-410006AC	1
	10A			MRE006-410010AC	1	36	63,46 \$
	16A			MRE006-410016AC	1	36	63,46 \$
	20A			MRE006-410020AC	1	36	63,46 \$
	25A			MRE006-410025AC	1	36	63,46 \$
	32A			MRE006-410032AC	1	36	63,46 \$
	40A			MRE006-410040AC	1	36	63,46 \$
	63A			MRE006-410063AC	1	36	63,46 \$
	6A			100mA	A Tipi	MRE006-410006A	1
	10A	MRE006-410010A	1			36	63,46 \$
	16A	MRE006-410016A	1			36	63,46 \$
	20A	MRE006-410020A	1			36	63,46 \$
	25A	MRE006-410025A	1			36	63,46 \$
	32A	MRE006-410032A	1			36	63,46 \$
	40A	MRE006-410040A	1			36	63,46 \$
	63A	MRE006-410063A	1			36	63,46 \$
	6A	300 mA	AC Tipi			MRE006-430006AC	1
	10A			MRE006-430010AC	1	36	63,46 \$
	16A			MRE006-430016AC	1	36	63,46 \$
	20A			MRE006-430020AC	1	36	63,46 \$
25A	MRE006-430025AC			1	36	63,46 \$	
32A	MRE006-430032AC			1	36	63,46 \$	
40A	MRE006-430040AC			1	36	63,46 \$	
63A	MRE006-430063AC			1	36	63,46 \$	
6A	300 mA			A Tipi	MRE006-430006A	1	36
10A		MRE006-430010A	1		36	63,46 \$	
16A		MRE006-430016A	1		36	63,46 \$	
20A		MRE006-430020A	1		36	63,46 \$	
25A		MRE006-430025A	1		36	63,46 \$	
32A		MRE006-430032A	1		36	63,46 \$	
40A		MRE006-430040A	1		36	63,46 \$	
63A		MRE006-430063A	1		36	63,46 \$	



## CE KAÇAK AKIM KORUMALI SİGORTALAR - (MEKANİK) 6kA (RCBO)

### MRCO06 SERİSİ

Kutup Sayısı	In (A) Anma Akımı	mA	Tipi	Ürün Kodu	Kutu Adedi	Koli Adedi	Fiyat (\$)
2P	6A	10 mA	AC Tipi	MRCO06-201006AC	1	60	61,54 \$
	16A			MRCO06-201016AC	1	60	61,54 \$
	20A			MRCO06-201020AC	1	60	61,54 \$
	25A			MRCO06-201025AC	1	60	61,54 \$
	6A	10 mA	A Tipi	MRCO06-201006A	1	60	61,54 \$
	16A			MRCO06-201016A	1	60	61,54 \$
	20A			MRCO06-201020A	1	60	61,54 \$
	25A			MRCO06-201025A	1	60	61,54 \$
	6A	30 mA	AC Tipi	MRCO06-203006AC	1	60	61,54 \$
	16A			MRCO06-203016AC	1	60	61,54 \$
	20A			MRCO06-203020AC	1	60	61,54 \$
	25A			MRCO06-203025AC	1	60	61,54 \$
	32A			MRCO06-203032AC	1	60	61,54 \$
	40A			MRCO06-203040AC	1	60	61,54 \$
	63A			MRCO06-203063AC	1	60	76,93 \$
	6A	30 mA	A Tipi	MRCO06-203006A	1	60	61,54 \$
	16A			MRCO06-203016A	1	60	61,54 \$
	20A			MRCO06-203020A	1	60	61,54 \$
	25A			MRCO06-203025A	1	60	61,54 \$
	32A			MRCO06-203032A	1	60	61,54 \$
	40A			MRCO06-203040A	1	60	61,54 \$
	63A			MRCO06-203063A	1	60	76,92 \$
	6A	100 mA	AC Tipi	MRCO06-210006AC	1	60	61,54 \$
	16A			MRCO06-210016AC	1	60	61,54 \$
	20A			MRCO06-210020AC	1	60	61,54 \$
	25A			MRCO06-210025AC	1	60	61,54 \$
	32A			MRCO06-210032AC	1	60	61,54 \$
	40A			MRCO06-210040AC	1	60	61,54 \$
	63A			MRCO06-210063AC	1	60	76,92 \$
	6A	100 mA	A Tipi	MRCO06-210006A	1	60	61,54 \$
	16A			MRCO06-210016A	1	60	61,54 \$
	20A			MRCO06-210020A	1	60	61,54 \$
	25A			MRCO06-210025A	1	60	61,54 \$
	32A			MRCO06-210032A	1	60	61,54 \$
	40A			MRCO06-210040A	1	60	61,54 \$
	63A			MRCO06-210063A	1	60	76,92 \$
	6A	300 mA	AC Tipi	MRCO06-230006AC	1	60	61,54 \$
	16A			MRCO06-230016AC	1	60	61,54 \$
	20A			MRCO06-230020AC	1	60	61,54 \$
	25A			MRCO06-230025AC	1	60	61,54 \$
	32A			MRCO06-230032AC	1	60	61,54 \$
	40A			MRCO06-230040AC	1	60	61,54 \$
	63A			MRCO06-230063AC	1	60	76,92 \$
	6A	300 mA	A Tipi	MRCO06-230006A	1	60	61,54 \$
	16A			MRCO06-230016A	1	60	61,54 \$
	20A			MRCO06-230020A	1	60	61,54 \$
	25A			MRCO06-230025A	1	60	61,54 \$
	32A			MRCO06-230032A	1	60	61,54 \$
40A	MRCO06-230040A			1	60	61,54 \$	
63A	MRCO06-230063A			1	60	76,92 \$	



## KAÇAK AKIM KORUMALI SİGORTALAR - (MEKANİK) 6kA (RCBO)

Kutup Sayısı	In (A) Anma Akımı	mA	Tipi	Ürün Kodu	Kutu Adedi	Koli Adedi	Fiyat (\$)
4P	6A	30 mA	AC Tipi	MRCO06-403006AC	1	30	111,54 \$
	16A			MRCO06-403016AC	1	30	111,54 \$
	20A			MRCO06-403020AC	1	30	111,54 \$
	25A			MRCO06-403025AC	1	30	111,54 \$
	32A			MRCO06-403032AC	1	30	111,54 \$
	40A			MRCO06-403040AC	1	30	111,54 \$
	63A			MRCO06-403063AC	1	30	134,62 \$
	6A			30 mA	A Tipi	MRCO06-403006A	1
	16A	MRCO06-403016A	1			30	111,54 \$
	20A	MRCO06-403020A	1			30	111,54 \$
	25A	MRCO06-403025A	1			30	111,54 \$
	32A	MRCO06-403032A	1			30	111,54 \$
	40A	MRCO06-403040A	1			30	111,54 \$
	63A	MRCO06-403063A	1			30	134,62 \$
	6A	100 mA	AC Tipi			MRCO06-410006AC	1
	16A			MRCO06-410016AC	1	30	111,54 \$
	20A			MRCO06-410020AC	1	30	111,54 \$
	25A			MRCO06-410025AC	1	30	111,54 \$
	32A			MRCO06-410032AC	1	30	111,54 \$
	40A			MRCO06-410040AC	1	30	111,54 \$
	63A			MRCO06-410063AC	1	30	134,62 \$
	6A			100mA	A Tipi	MRCO06-410006A	1
	16A	MRCO06-410016A	1			30	111,54 \$
	20A	MRCO06-410020A	1			30	111,54 \$
	25A	MRCO06-410025A	1			30	111,54 \$
	32A	MRCO06-410032A	1			30	111,54 \$
	40A	MRCO06-410040A	1			30	111,54 \$
	63A	MRCO06-410063A	1			30	134,62 \$
6A	300 mA	AC Tipi	MRCO06-430006AC			1	30
16A			MRCO06-430016AC	1	30	111,54 \$	
20A			MRCO06-430020AC	1	30	111,54 \$	
25A			MRCO06-430025AC	1	30	111,54 \$	
32A			MRCO06-430032AC	1	30	111,54 \$	
40A			MRCO06-430040AC	1	30	111,54 \$	
63A			MRCO06-430063AC	1	30	134,62 \$	
6A			300 mA	A Tipi	MRCO06-430006A	1	30
16A	MRCO06-430016A	1			30	111,54 \$	
20A	MRCO06-430020A	1			30	111,54 \$	
25A	MRCO06-430025A	1			30	111,54 \$	
32A	MRCO06-430032A	1			30	111,54 \$	
40A	MRCO06-430040A	1			30	111,54 \$	
63A	MRCO06-430063A	1			30	134,62 \$	



### MRCO06 SERİSİ

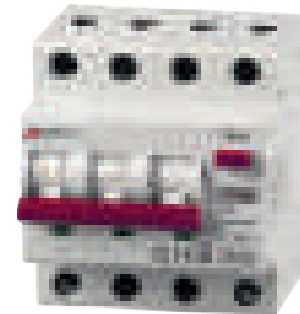

## CE ARK HATASI ALGILAMA RÖLESİ (AFDD)

### MTH SERİSİ

ŞALT GRUBU

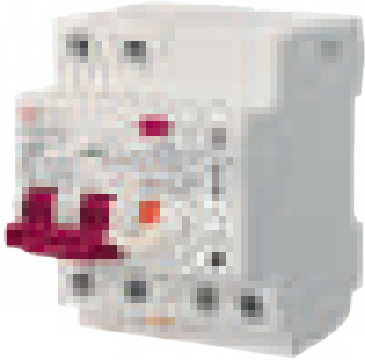

Kutup Sayısı	In (A) Anma Akımı	mA	Tip	Ürün Kodu	Kutu Adedi	Koli Adedi	Fiyat (\$)
2P	6A	30 mA	RCCB+AFDD-32	MAFDR1C06-203006	1	100	182,45 \$
	10A			MAFDR1C06-203010	1	100	182,45 \$
	16A			MAFDR1C06-203016	1	100	182,45 \$
	20A			MAFDR1C06-203020	1	100	182,45 \$
	25A			MAFDR1C06-203025	1	100	182,45 \$
	32A			MAFDR1C06-203032	1	100	182,45 \$
	6A	30 mA	RCBO+AFDD-32	MAFDR1C006-203006	1	100	182,45 \$
	10A			MAFDR1C006-203010	1	100	182,45 \$
	16A			MAFDR1C006-203016	1	100	182,45 \$
	20A			MAFDR1C006-203025	1	100	182,45 \$
	25A			MAFDR1C006-203030	1	100	182,45 \$
	32A			MAFDR1C006-203032	1	100	182,45 \$
	6A	30 mA	MCB + AFDD-32	MAFDT1S06-2006	1	100	170,26 \$
	10A			MAFDT1S06-2010	1	100	170,26 \$
	16A			MAFDT1S06-2016	1	100	170,26 \$
	20A			MAFDT1S06-2020	1	100	170,26 \$
	25A			MAFDT1S06-2025	1	100	170,26 \$
	32A			MAFDT1S06-2032	1	100	170,26 \$
2P	6A	30 mA	RCCB+AFDD-63	MAFDR2C06-203006	1	50	184,86 \$
	10A			MAFDR2C06-203010	1	50	184,86 \$
	16A			MAFDR2C06-203016	1	50	184,86 \$
	20A			MAFDR2C06-203020	1	50	184,86 \$
	25A			MAFDR2C06-203025	1	50	184,86 \$
	32A			MAFDR2C06-203032	1	50	184,86 \$
	40A			MAFDR2C06-203040	1	50	184,86 \$
	50A			MAFDR2C06-203050	1	50	184,86 \$
	63A			MAFDR2C06-203063	1	50	184,86 \$
	6A	30 mA	RCBO+AFDD-63	MAFDR2C006-203006	1	50	184,86 \$
	10A			MAFDR2C006-203010	1	50	184,86 \$
	16A			MAFDR2C006-203016	1	50	184,86 \$
	20A			MAFDR2C006-203025	1	50	184,86 \$
	25A			MAFDR2C006-203030	1	50	184,86 \$
	32A			MAFDR2C006-203032	1	50	184,86 \$
	40A			MAFDR2C006-203040	1	50	184,86 \$
	50A			MAFDR2C006-203050	1	50	184,86 \$
	63A			MAFDR2C006-203063	1	50	184,86 \$
2P	6A	30 mA	MCB + AFDD-63	MAFDT2S06-2006	1	50	172,75 \$
	10A			MAFDT2S06-2010	1	50	172,75 \$
	16A			MAFDT2S06-2016	1	50	172,75 \$
	20A			MAFDT2S06-2020	1	50	172,75 \$
	25A			MAFDT2S06-2025	1	50	172,75 \$
	32A			MAFDT2S06-2032	1	50	172,75 \$
	40A			MAFDT2S06-2040	1	50	172,75 \$
	50A			MAFDT2S06-2050	1	50	172,75 \$
	63A			MAFDT2S06-2063	1	50	172,75 \$

## İZOLATÖRLER - YÜK AYIRICILAR

Kutup Sayısı	In (A) Anma Akımı	Ürün Kodu	Kutu Adedi	Koli Adedi	Fiyat (\$)
1P	32A	MTSIS-1032	12	240	5,77 \$
	40A	MTSIS-1040	12	240	5,77 \$
	63A	MTSIS-1063	12	240	5,77 \$
	80A	MTSIS-1080	12	240	8,46 \$
	100A	MTSIS-1100	12	240	8,46 \$
	125A	MTSIS-1125	12	240	8,46 \$
2P	32A	MTSIS-2032	6	120	11,54 \$
	40A	MTSIS-2040	6	120	11,54 \$
	63A	MTSIS-2063	6	120	11,54 \$
	80A	MTSIS-2080	6	120	15,38 \$
	100A	MTSIS-2100	6	120	15,38 \$
	125A	MTSIS-2125	6	120	15,38 \$
3P	32A	MTSIS-3032	4	80	17,31 \$
	40A	MTSIS-3040	4	80	17,31 \$
	63A	MTSIS-3063	4	80	17,31 \$
	80A	MTSIS-3080	4	80	19,23 \$
	100A	MTSIS-3100	4	80	19,23 \$
	125A	MTSIS-3125	4	80	19,23 \$
4P	32A	MTSIS-4032	3	60	21,15 \$
	40A	MTSIS-4040	3	60	19,23 \$
	63A	MTSIS-4063	3	60	19,23 \$
	80A	MTSIS-4080	3	60	25,00 \$
	100A	MTSIS-4100	3	60	25,00 \$
	125A	MTSIS-4125	3	60	25,00 \$

CE

MTSIS SERİSİ

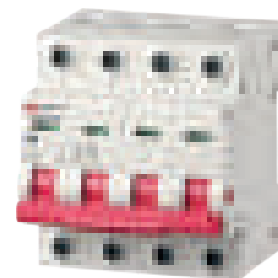



## KOMPAKT TİP DEVRE KESİCİLER - TERMİK MANYETİK - SABİT TİP

### MTF SERİSİ

Kutup Sayısı	In (A) Anma Akımı	kA	Ürün Kodu	Kutu Adedi	Koli Adedi	Fiyat (\$)
3P	16A	25 kA	MTF25-3016	1	24	84,48 \$
	25A		MTF25-3025	1	24	84,48 \$
	32A		MTF25-3032	1	24	84,48 \$
	40A		MTF25-3040	1	24	84,48 \$
	50A		MTF25-3050	1	24	84,48 \$
	63A		MTF25-3063	1	24	84,48 \$
	80A		MTF25-3080	1	24	84,48 \$
	100A		MTF25-3100	1	24	91,10 \$
	125A		MTF25-3125	1	24	91,10 \$
	160A		MTF25-3160	1	24	91,10 \$
	100A	35 kA	MTF35-3100	1	18	138,46 \$
	125A		MTF35-3125	1	18	138,46 \$
	160A		MTF35-3160	1	18	138,46 \$
	200A		MTF35-3200	1	18	138,46 \$
	250A		MTF35-3250	1	18	138,46 \$
	315A	50 kA	MTF50-30315	1	4	496,21 \$
	400A		MTF50-30400	1	4	498,14 \$
	500A		MTF50-30500	1	2	746,28 \$
	630A		MTF50-30630	1	2	749,17 \$
	800A	MTF50-30800	1	2	898,66 \$	
	1000A	65 kA	MTF65-3100	1	1	1.923,08 \$
1250A	MTF65-31250		1	1	1.923,08 \$	
1600A	MTF65-31600		1	1	2.307,69 \$	
4P	16A	25 kA	MTF25-4016	1	18	119,66 \$
	25A		MTF25-4025	1	18	119,66 \$
	32A		MTF25-4032	1	18	119,66 \$
	40A		MTF25-4040	1	18	119,66 \$
	50A		MTF25-4050	1	18	119,66 \$
	63A		MTF25-4063	1	18	119,66 \$
	80A		MTF25-4080	1	18	125,52 \$
	100A		MTF25-4100	1	18	129,13 \$
	125A		MTF25-4125	1	18	134,44 \$
	160A		MTF25-4160	1	18	140,16 \$
	100A	35 kA	MTF35-4100	1	12	184,56 \$
	125A		MTF35-4125	1	12	184,56 \$
	160A		MTF35-4160	1	12	184,56 \$
	200A		MTF35-4200	1	12	184,56 \$
	250A		MTF35-4250	1	12	184,56 \$
	315A	50 kA	MTF50-40315	1	3	482,76 \$
	400A		MTF50-40400	1	3	517,24 \$
	500A		MTF50-40500	1	2	919,69 \$
	630A		MTF50-40630	1	2	923,26 \$
	800A	MTF50-40800	1	2	1.137,16 \$	
	1000A	65 kA	MTF65-41000	1	1	2.692,31 \$
1250A	MTF65-41250		1	1	2.692,31 \$	
1600A	MTF65-41600		1	1	2.884,62 \$	



## KOMPAKT TİP DEVRE KESİCİLER - TERMİK MANYETİK - AYAR SAHALI



### MTA SERİSİ

Kutup Sayısı	In (A) Anma Akımı	kA	Ürün Kodu	Kutu Adedi	Koli Adedi	Fiyat (\$)
3P	16A	25 kA	MTA25-3016	1	24	170,01 \$
	25A		MTA25-3025	1	24	170,01 \$
	32A		MTA25-3032	1	24	170,01 \$
	40A		MTA25-3040	1	24	174,87 \$
	50A		MTA25-3050	1	24	174,86 \$
	63A		MTA25-3063	1	24	187,13 \$
	80A		MTA25-3080	1	24	187,13 \$
	100A		MTA25-3100	1	24	193,59 \$
	125A		MTA25-3125	1	24	199,35 \$
	160A		MTA25-3160	1	24	204,83 \$
	100A	35 kA	MTA35-3100	1	18	122,03 \$
	125A		MTA35-3125	1	18	155,26 \$
	160A		MTA35-3160	1	18	161,47 \$
	200A		MTA35-3200	1	18	196,69 \$
	250A		MTA35-3250	1	18	205,90 \$
	315A	50 kA	MTA50-30315	1	4	379,31 \$
	400A		MTA50-30400	1	4	413,51 \$
	500A		MTA50-30500	1	2	555,91 \$
	630A		MTA50-30630	1	2	555,91 \$
	800A		MTA50-30800	1	2	684,58 \$
4P	16A	25 kA	MTA25-4016	1	18	213,89 \$
	25A		MTA25-4025	1	18	213,89 \$
	32A		MTA25-4032	1	18	213,89 \$
	40A		MTA25-4040	1	18	219,61 \$
	50A		MTA25-4050	1	18	229,03 \$
	63A		MTA25-4063	1	18	229,03 \$
	80A		MTA25-4080	1	18	235,03 \$
	100A		MTA25-4100	1	18	235,03 \$
	125A		MTA25-4125	1	18	239,53 \$
	160A		MTA25-4160	1	18	246,97 \$
	100A	35 kA	MTA35-4100	1	12	163,53 \$
	125A		MTA35-4125	1	12	255,34 \$
	160A		MTA35-4160	1	12	273,06 \$
	200A		MTA35-4200	1	12	320,31 \$
	250A		MTA35-4250	1	12	343,91 \$
	315A	50 kA	MTA50-40315	1	3	480,77 \$
	400A		MTA50-40400	1	3	500,00 \$
	500A		MTA50-40500	1	2	673,08 \$
	630A		MTA50-40630	1	2	673,08 \$
	800A		MTA50-40800	1	2	788,46 \$





## KOMPAKT TİP DEVRE KESİCİLER - TERMİK MANYETİK - KAÇAK AKIMLI

### MTL SERİSİ

Kutup Sayısı	In (A) Anma Akımı	kA	Ürün Kodu	Kutu Adedi	Koli Adedi	Fiyat (\$)
3P	16A	25 kA	MTL25-3016	1	24	288,91 \$
	25A		MTL25-3025	1	24	288,91 \$
	32A		MTL25-3032	1	24	288,91 \$
	40A		MTL25-3040	1	24	300,71 \$
	50A		MTL25-3050	1	24	310,30 \$
	63A		MTL25-3063	1	24	310,30 \$
	80A		MTL25-3080	1	24	317,99 \$
	100A		MTL25-3100	1	24	317,99 \$
	125A		MTL25-3125	1	24	327,33 \$
	100A	35 kA	MTL35-3100	1	18	214,34 \$
	125A		MTL35-3125	1	18	247,59 \$
	160A		MTL35-3160	1	18	258,97 \$
	200A		MTL35-3200	1	18	319,52 \$
	250A		MTL35-3250	1	18	338,34 \$
	315A	50 kA	MTL50-30315	1	4	694,32 \$
	400A		MTL50-30400	1	4	694,32 \$
	500A		MTL50-30500	1	2	1.279,59 \$
	630A		MTL50-30630	1	2	1.279,59 \$
800A	MTL50-30800		1	2	1.373,60 \$	
4P	16A	25 kA	MTL25-4016	1	18	254,24 \$
	25A		MTL25-4025	1	18	268,47 \$
	32A		MTL25-4032	1	18	269,23 \$
	40A		MTL25-4040	1	18	273,08 \$
	50A		MTL25-4050	1	18	273,08 \$
	63A		MTL25-4050	1	18	273,08 \$
	80A		MTL25-4063	1	18	273,08 \$
	100A		MTL25-4080	1	18	288,46 \$
	125A		MTL25-4100	1	18	288,46 \$
	100A	35 kA	MTL35-4100	1	12	288,46 \$
	125A		MTL35-4125	1	12	284,45 \$
	160A		MTL35-4160	1	12	300,37 \$
	200A		MTL35-4200	1	12	372,54 \$
	250A		MTL35-4250	1	12	391,65 \$
	315A	50 kA	MTL50-40315	1	3	874,75 \$
	400A		MTL50-40400	1	3	874,75 \$
	500A		MTL50-40500	1	2	1.496,48 \$
	630A		MTL50-40630	1	2	1.496,48 \$
800A	MTL50-40800		1	2	1.739,78 \$	



## AÇIK TİP DEVRE KESİCİLER - SABİT TİP



### MTACF SERİSİ

ŞALT GRUBU

Kutup Sayısı	In (A) Anma Akımı	kA	Ürün Kodu	Kutu Adedi	Koli Adedi	Fiyat (\$)
3P	1000A	65 kA	MTACF3-0651000	1	1	2.602,73 \$
	1250A		MTACF3-0651250	1	1	2.825,43 \$
	1600A		MTACF3-0651600	1	1	3.106,23 \$
	2000A		MTACF3-0652000	1	1	3.660,08 \$
	2500A		MTACF3-0652500	1	1	4.676,77 \$
	3200A		MTACF3-0653200	1	1	5.490,12 \$
	4000A	120 kA	MTACF3-1204000	1	1	13.460,06 \$
	5000A		MTACF3-1205000	1	1	23.981,12 \$
	6300A		MTACF3-1206300	1	1	27.070,22 \$
4P	1000A	65 kA	MTACF4-0651000	1	1	3.863,42 \$
	1250A		MTACF4-0651250	1	1	4.066,76 \$
	1600A		MTACF4-0651600	1	1	4.371,77 \$
	2000A		MTACF4-0652000	1	1	4.575,10 \$
	2500A		MTACF4-0652500	1	1	5.896,80 \$
	3200A		MTACF4-0653200	1	1	6.913,49 \$
	4000A	120 kA	MTACF4-1204000	1	1	17.535,66 \$
	5000A		MTACF4-1205000	1	1	22.602,58 \$
	6300A		MTACF4-1206300	1	1	24.581,42 \$



## AÇIK TİP DEVRE KESİCİLER - ÇEKMECELİ TİP



### MTACD SERİSİ

Kutup Sayısı	In (A) Anma Akımı	kA	Ürün Kodu	Kutu Adedi	Koli Adedi	Fiyat (\$)
3P	1000A	65 kA	MTACD3-0651000	1	1	3.290,45 \$
	1250A		MTACD3-0651250	1	1	3.290,45 \$
	1600A		MTACD3-0651600	1	1	3.718,18 \$
	2000A		MTACD3-0652000	1	1	4.447,29 \$
	2500A		MTACD3-0652500	1	1	5.694,43 \$
	3200A		MTACD3-0653200	1	1	6.470,99 \$
	4000A	120 kA	MTACD3-1204000	1	1	15.229,97 \$
	5000A		MTACD3-1205000	1	1	18.301,38 \$
	6300A		MTACD3-1206300	1	1	25.574,26 \$
4P	1000A	65 kA	MTACD4-0651000	1	1	6.011,83 \$
	1250A		MTACD4-0651250	1	1	5.806,42 \$
	1600A		MTACD4-0651600	1	1	5.806,42 \$
	2000A		MTACD4-0652000	1	1	6.949,90 \$
	2500A		MTACD4-0652500	1	1	9.770,94 \$
	3200A		MTACD4-0653200	1	1	10.380,34 \$
	4000A	120 kA	MTACD4-1204000	1	1	13.504,07 \$
	5000A		MTACD4-1205000	1	1	24.759,45 \$
	6300A		MTACD4-1206300	1	1	26.793,06 \$



## KOMPAKT TİP DEVRE KESİCİLER - TERMİK MANYETİK AKSESUARLARI

Ürün Kodu	Ürün Adı	Kutu Adedi	Koli Adedi	Fiyat (\$)
MTAUX-11250	1NO+1NC 160 - 250A Yardımcı Kontakt	30	600	23,62 \$
MTAUX-22250	2NO+2NC 160 - 250A Yardımcı Kontakt	30	600	38,48 \$
MTALR-00160	160A Alarm Kontakt	30	600	25,64 \$
MTALR-00250	250A Alarm Kontakt	30	600	25,64 \$
MTSHT-230160	230V Şant Trip Bobini 160 A	30	600	30,77 \$
MTSHT-230250	230V Şant Trip Bobini 250 A	30	600	32,69 \$
MTSHT-230630	230V Şant Trip Bobini 400-630A	10	80	36,54 \$
MTSHT-230800	230V Şant Trip Bobini 800A	10	80	40,38 \$
MTALR-001250	Alarm Kontakt 65kA	30	600	39,13 \$
MTAUX-221250	Aux. Kontakt 65kA	30	600	29,34 \$
MTMO-1000	Motor Mekanizması 65kA	1	8	361,84 \$
MTRH-1000	Döner Uzatma Kolu 65kA	1	8	92,88 \$
MTSHT-2301250	Şant Trip Bobini 65kA	10	80	48,87 \$

## AÇIK TİP DEVRE KESİCİLER - TERMİK MANYETİK AKSESUARLARI

Ürün Kodu	Ürün Adı	Kutu Adedi	Koli Adedi	Fiyat (\$)
MTACCC-1000	Kapama Bobini (230/400V)	20	60	72,98 \$
MTACHC-1000	3H Kontrolör	1	6	486,56 \$
MTACIUV-1000	Düşük Gerilim Bobini (230/400V)	5	40	121,66 \$
MTACM-1000	Motor	1	8	218,94 \$
MTACMC-1000	3M Kontrolör	1	6	243,24 \$
MTACMIM-1000	Mekanik Kilitleme Ünitesi	1	5	547,36 \$
MTACMM-6000	Motor Mekanizması 2000-4000-6000A	1	8	1.337,96 \$
MTACSHT-2301000	Açtırma Bobini	20	60	72,98 \$
MTACSUV-1000	Gecikmesiz Düşük Gerilim Bobini (230/400V)	1	27	279,74 \$
MTACUV-1000	Gecikmeli Düşük Gerilim Bobini	1	27	316,23 \$



### MIROO SERİSİ



### DARBE AKIM RÖLESİ

Kontakt	In (A) Anma Akımı	Ürün Kodu	Kutu Adedi	Koli Adedi	Fiyat (\$)
1NO	16A	MIR00-123016	12	120	23,97 \$
2NO	16A	MIR00-223016	12	120	23,97 \$



### MATRO SERİSİ



### ANALOG ZAMAN SAATİ

Ürün Kodu	Ürün Adı	Kutu Adedi	Koli Adedi	Fiyat (\$)
MATRO-100	100 Saat Analog Zaman Saati	1	100	23,45 \$



### MTC00 SERİSİ



### TOROİD AKIM TRAFOLARI

Ölçüsü	Ürün Kodu	Kutu Adedi	Koli Adedi	Fiyat (\$)
40 mm	MTC00-040	1	100	33,02 \$
80 mm	MTC00-080	1	60	39,00 \$
120 mm	MTC00-120	1	60	55,47 \$
160 mm	MTC00-160	1	30	101,59 \$
210 mm	MTC00-210	1	28	150,75 \$



### KAÇAK AKIM ALGILAMA RÖLESİ



Ürün Kodu	Ürün Adı	Kutu Adedi	Koli Adedi	Fiyat (\$)
MELR00-01	Kaçak Akım Algılama Rölesi	1	36	119,28 \$

## AC KONTAKTÖRLER - 230V AC

Kutup Sayısı	In (A) Anma Akımı	kW	Kontak	Voltaj (V)	Ürün Kodu	Kutu Adedi	Koli Adedi	Fiyat (\$)
3P	9A	4kW	1NO	230V AC	MTMA10-3009	1	50	14,86 \$
	9A	4kW	1NC		MTMA01-3009	1	50	14,86 \$
	9A	4kW	1NO+1NC		MTMA11-3009	1	50	15,21 \$
	12A	5,5kW	1NO		MTMA10-3012	1	50	15,57 \$
	12A	5,5kW	1NC		MTMA01-3012	1	50	15,57 \$
	12A	5,5kW	1NO+1NC		MTMA11-3012	1	50	15,92 \$
	18A	7,5kW	1NO		MTMA10-3018	1	50	17,96 \$
	18A	7,5kW	1NC		MTMA01-3018	1	50	17,96 \$
	18A	7,5kW	1NO+1NC		MTMA11-3018	1	50	18,57 \$
	25A	11kW	1NO		MTMA10-3025	1	50	24,15 \$
	25A	11kW	1NC		MTMA01-3025	1	50	24,15 \$
	25A	11kW	1NO+1NC		MTMA11-3025	1	50	25,47 \$
	32A	15kW	1NO		MTMA10-3032	1	50	37,06 \$
	32A	15kW	1NC		MTMA01-3032	1	50	37,06 \$
	32A	15kW	1NO+1NC		MTMA11-3032	1	50	39,26 \$
	40A	18,5kW	1NO+1NC		MTMA11-3040	1	20	72,23 \$
	50A	22kW	1NO+1NC		MTMA11-3050	1	20	72,26 \$
	65A	30kW	1NO+1NC		MTMA11-3065	1	20	88,46 \$
80A	37kW	1NO+1NC	MTMA11-3080	1	12	113,46 \$		
95A	45kW	1NO+1NC	MTMA11-3095	1	12	116,54 \$		
4P	9A	4kW		230V AC	MTMA10-4009	1	50	19,23 \$
	12A	5,5kW			MTMA10-4012	1	50	21,15 \$
	25A	11kW			MTMA10-4025	1	50	31,92 \$
	40A	18,5kW			MTMA11-4040	1	20	84,62 \$
	50A	22kW			MTMA11-4050	1	20	96,15 \$
	65A	30kW			MTMA11-4065	1	20	111,54 \$
	80A	37kW			MTMA11-4080	1	10	150,00 \$
	95A	45kW			MTMA11-4095	1	10	157,69 \$

CE

MTMA SERİSİ



ŞALT GRUBU

## AC KONTAKTÖR YARDIMCI BLOKLARI

Ürün Kodu	Ürün Adı	Kutu Adedi	Koli Adedi	Fiyat (\$)
MTMAUX-UPBLOCKA	AC-3 KONTAKTÖR ÜST BLOK A	1	300	4,04 \$
MTMAUX-UPBLOCKB	AC-3 KONTAKTÖR ÜST BLOK B	1	208	6,64 \$
MTMAUX-SIDEBLOCK	AC-3 KONTAKTÖR YAN BLOK	1	128	7,12 \$

## MİNİ KONTAKTÖRLER

Kutup Sayısı	In (A) Anma Akımı	kW	Kontak	Voltaj (V)	Ürün Kodu	Kutu Adedi	Koli Adedi	Fiyat (\$)
3P	9A	4kW	1NO	230V AC	MTMK10-3009	1	100	14,46 \$
	12A	5,5kW	1NO		MTMK10-3012	1	100	15,26 \$
	16A	7,5kW	1NO		MTMK10-3016	1	100	23,03 \$
	9A	4kW	1NC	230V AC	MTMK01-3009	1	100	14,46 \$
	12A	5,5kW	1NC		MTMK01-3012	1	100	15,26 \$
	16A	7,5kW	1NC		MTMK01-3016	1	100	23,03 \$
	9A	4kW	1NO	24V DC	MTMK10-3009DC24	1	100	35,07 \$
	12A	5,5kW	1NO		MTMK10-3012DC24	1	100	37,09 \$
	16A	7,5kW	1NO		MTMK10-3016DC24	1	100	39,12 \$
	9A	4kW	1NC	24V DC	MTMK01-3009DC24	1	100	35,07 \$
	12A	5,5kW	1NC		MTMK01-3012DC24	1	100	37,09 \$
	16A	7,5kW	1NC		MTMK01-3016DC24	1	100	39,12 \$

CE

MTMK SERİSİ



## MİNİ KONTAKTÖR YARDIMCI BLOKLARI

Ürün Kodu	Ürün Adı	Kutu Adedi	Koli Adedi	Fiyat (\$)
MTMKUX-UPBLOCKA	AC-3 MİNİ KONTAKTÖR ÜST BLOK A (1NO + 1NC)	1	300	5,57 \$
MTMKUX-UPBLOCKB	AC-3 MİNİ KONTAKTÖR ÜST BLOK B (2NO + 2NC)	1	208	8,46 \$

## CE MODÜLER KONTAKTÖRLER

### MTMCO SERİSİ

Kutup Sayısı	In (A) Anma Akımı	Kontakt	mm	Ürün Kodu	Kutu Adedi	Koli Adedi	Fiyat (\$)	
2P	16A	1NO+1NC	18 mm	MTMCO-201611	1	140	17,48 \$	
	16A	2NO		MTMCO-201620	1	140	17,48 \$	
	16A	2NC		MTMCO-201602	1	140	17,48 \$	
	25A	1NO+1NC		MTMCO-202511	1	140	19,21 \$	
	25A	2NO		MTMCO-202520	1	140	19,21 \$	
	25A	2NC		MTMCO-202502	140	19,21 \$		
	32A	1NO+1NC	36 mm	MTMCO-203211	1	70	41,86 \$	
	32A	2NO		MTMCO-203220	1	70	41,86 \$	
	32A	2NC		MTMCO-203202	1	70	41,86 \$	
	40A	1NO+1NC		MTMCO-204011	1	70	46,55 \$	
	40A	2NO		MTMCO-204020	1	70	46,55 \$	
	40A	2NC		MTMCO-204002	1	70	46,55 \$	
	63A	1NO+1NC		MTMCO-206311	1	70	50,00 \$	
	63A	2NO		MTMCO-206320	1	70	50,00 \$	
	63A	2NC		MTMCO-206302	1	70	50,00 \$	
	80A	1NO+1NC		54 mm	MTMCO-208011	1	50	110,86 \$
	80A	2NO			MTMCO-208020	1	50	110,86 \$
	80A	2NC			MTMCO-208002	1	50	110,86 \$
100A	1NO+1NC	MTMCO-2010011	1		50	110,86 \$		
100A	2NO	MTMCO-2010020	1		50	110,86 \$		
100A	2NC	MTMCO-2010002	1		50	110,86 \$		
4P	16A	2NO+2NC	36 mm	MTMCO-401622	1	70	24,14 \$	
	16A	3NO+1NC		MTMCO-401631	1	70	24,14 \$	
	16A	1NO+3NC		MTMCO-401613	1	70	24,14 \$	
	16A	4NO		MTMCO-401640	1	70	24,14 \$	
	16A	4NC		MTMCO-401604	1	70	24,14 \$	
	25A	2NO+2NC		MTMCO-402522	1	70	31,03 \$	
	25A	3NO+1NC		MTMCO-402531	1	70	31,03 \$	
	25A	1NO+3NC		MTMCO-402513	1	70	31,03 \$	
	25A	4NO		MTMCO-402540	1	70	31,03 \$	
	25A	4NC		MTMCO-402504	1	70	31,03 \$	
	32A	2NO+2NC		54 mm	MTMCO-403222	1	50	54,48 \$
	32A	3NO+1NC			MTMCO-403231	1	50	54,48 \$
	32A	1NO+3NC	MTMCO-403213		1	50	54,48 \$	
	32A	4NO	MTMCO-403240		1	50	54,48 \$	
	32A	4NC	MTMCO-403204		1	50	54,48 \$	
	40A	2NO+2NC	MTMCO-404022		1	50	51,72 \$	
	40A	3NO+1NC	MTMCO-404031		1	50	51,72 \$	
	40A	1NO+3NC	MTMCO-404013		1	50	51,72 \$	
	40A	4NO	MTMCO-404040		1	50	51,72 \$	
	40A	4NC	MTMCO-404004		1	50	51,72 \$	
	63A	2NO+2NC	MTMCO-406322		1	50	52,21 \$	
	63A	3NO+1NC	MTMCO-406331		1	50	52,21 \$	
	63A	1NO+3NC	MTMCO-406313		1	50	52,21 \$	
	63A	4NO	MTMCO-406340		1	50	52,21 \$	
	63A	4NC	MTMCO-406304		1	50	52,21 \$	
	80A	2NO+2NC	108 mm		MTMCO-408022	1	30	179,65 \$
	80A	3NO+1NC			MTMCO-408031	1	30	179,65 \$
	80A	1NO+3NC			MTMCO-408013	1	30	179,65 \$
	80A	4NO		MTMCO-408040	1	30	179,65 \$	
	80A	4NC		MTMCO-408004	1	30	179,65 \$	
100A	2NO+2NC	MTMCO-410022		1	30	179,65 \$		
100A	3NO+1NC	MTMCO-410031		1	30	179,65 \$		
100A	1NO+3NC	MTMCO-410013		1	30	179,65 \$		
100A	4NO	MTMCO-410040		1	30	179,65 \$		
100A	4NC	MTMCO-410004		1	30	179,65 \$		



## AC KOMPANZASYON KONTAKTÖRLERİ VE BLOKLARI

Kutup Sayısı	In (A) Anma Akımı	kVAr	Kontakt	Ürün Kodu	Kutu Adedi	Koli Adedi	Fiyat (\$)
3P	18A	7,5kVAr	1NO+1NC	MTMAC1-318	1	18	54,17 \$
	25A	12kVAr	1NO+1NC	MTMAC1-325	1	18	70,88 \$
	32A	18kVAr	1NO+1NC	MTMAC1-332	1	18	100,84 \$
	43A	20kVAr	1NO+1NC	MTMAC1-343	1	20	172,41 \$
	50A	25kVAr	2NO +1NC	MTMAC1-350	1	20	178,06 \$
	65A	30kVAr	2NO +1NC	MTMAC1-365	1	20	258,62 \$
	80A	40kVAr	2NO +1NC	MTMAC1-380	1	20	273,13 \$
	95A	50kVAr	2NO +1NC	MTMAC1-395	1	20	281,78 \$

## TERMİK RÖLELER

Termik Ayar Sahası (A)	Ürün Kodu	Kutu Adedi	Koli Adedi	Fiyat (\$)
0,1 ~ 0,16A	MTTR1-M1301	1	50	15,00 \$
0,16 ~ 0,25A	MTTR1-M1302	1	50	15,00 \$
0,25 ~ 0,40A	MTTR1-M1303	1	50	15,00 \$
0,40 ~ 0,63A	MTTR1-M1304	1	50	15,00 \$
0,63 ~ 1A	MTTR1-M1305	1	50	15,00 \$
1 ~ 1,6A	MTTR1-M1306	1	50	15,00 \$
1,6 ~ 2,5A	MTTR1-M1307	1	50	15,00 \$
2,5 ~ 4A	MTTR1-M1308	1	50	15,00 \$
4 ~ 6A	MTTR1-M1310	1	50	15,00 \$
5,5 ~ 8A	MTTR1-M1312	1	50	15,00 \$
7 ~ 10A	MTTR1-M1314	1	50	15,00 \$
9 ~ 13A	MTTR1-M1316	1	50	15,00 \$
12 ~ 18A	MTTR1-M1321	1	50	15,00 \$
17 ~ 25A	MTTR1-M1322	1	50	15,00 \$
23 ~ 32A	MTTR2-M2353	1	75	19,23 \$
30 ~ 40A	MTTR2-M2355	1	75	19,23 \$
17 ~ 25A	MTTR3-M3322	1	50	26,92 \$
23 ~ 32A	MTTR3-M3353	1	50	26,92 \$
30 ~ 40A	MTTR3-M3355	1	50	26,92 \$
37 ~ 50A	MTTR3-M3357	1	50	27,31 \$
48 ~ 65A	MTTR3-M3359	1	50	27,50 \$
55 ~ 70A	MTTR3-M3361	1	50	27,69 \$
63 ~ 80A	MTTR3-M3363	1	50	28,85 \$
80 ~ 93A	MTTR3-M3365	1	50	30,77 \$

## MOTOR KORUMA ŞALTERLERİ

Termik Ayar Sahası (A)	Ürün Kodu	Kutu Adedi	Koli Adedi	Fiyat (\$)
0,1 - 0,16A	MTPSO-250016	1	50	30,15 \$
0,16 - 0,25A	MTPSO-250025	1	50	30,15 \$
0,25 - 0,40A	MTPSO-250040	1	50	30,15 \$
0,40 - 0,63A	MTPSO-250063	1	50	31,87 \$
0,63A	MTPSO-250100	1	50	31,87 \$
1 - 1,6A	MTPSO-250160	1	50	31,87 \$
1,6 - 2,5A	MTPSO-250250	1	50	31,87 \$
2,5 - 4A	MTPSO-250400	1	50	31,87 \$
4 - 6,3A	MTPSO-250630	1	50	33,18 \$
6 - 10A	MTPSO-251000	1	50	33,18 \$
9 - 14A	MTPSO-251400	1	50	33,59 \$
13 - 18A	MTPSO-251800	1	50	34,41 \$
17 - 23A	MTPSO-252300	1	50	35,31 \$
20 - 25A	MTPSO-252500	1	50	35,31 \$
24 - 32A	MTPSO-253200	1	50	46,15 \$
25 - 40A	MTPS1-804000	1	50	99,14 \$
36 - 50A	MTPS1-805000	1	50	105,69 \$
40 - 63A	MTPS1-806300	1	50	105,69 \$
56 - 80A	MTPS1-808000	1	50	146,66 \$

## MOTOR KORUMA ŞALTERİ AKSESUARLARI

Ürün Kodu	Ürün Adı	Kutu Adedi	Koli Adedi	Fiyat (\$)
MTPSO-F11	1NO+1NC Yardımcı Kontakt - Önden Monteli	1	1000	4,81 \$
MTPSO-F20	2NO Yardımcı Kontakt - Önden Monteli	1	1000	4,81 \$
MTPSO-L11	1NO+1NC Yardımcı Kontakt - Yandan Monteli	1	500	7,69 \$
MTPSO-L20	2NO Yardımcı Kontakt - Yandan Monteli	1	500	7,69 \$
MTPS1-L11	1NO+1NC Yardımcı Kontakt - Yandan Monteli	1	500	13,46 \$
MTPS1-L20	2NO Yardımcı Kontakt - Yandan Monteli	1	500	13,46 \$
MTPSO-AB	230V Şant Açırma Bobini	1	500	11,54 \$
MTPSO-DG	400V Düşük Gerilim Açırma Bobini	1	300	19,23 \$
MTPSO-IP55K	IP55 Kutu - Motor Koruma Şalteri	1	50	15,38 \$

CE

### MTMAC SERİSİ



CE

### MTTR SERİSİ



CE

### MTPSO SERİSİ

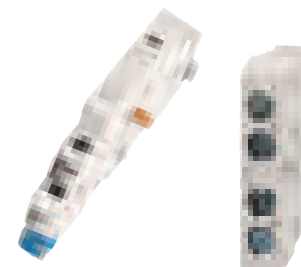

# ANAHTAR PRİZ GRUBU

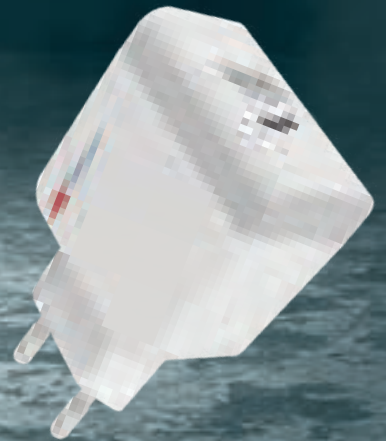

# MODÜLER SİSTEM

Mutlusan Modüler Seri, küçük bir alanda mümkün olduğu kadar çok ekipmanın kurulum imkanı da dahil olmak üzere, ekipman ve renk kombinasyonu seçiminde tam özerkliğe sahip olmak isteyen müşterilerin ihtiyaçlarına uygun olarak geliştirildi.

Bu seri aynı zamanda anahtar ve prizlerin uzun ömürlü olmasını ve rahat uygulanmasını garanti eden ekipman kalitesi açısından da beklentileri karşılıyor.

- Avrupa standartlarına uygun üretim
- Yüksek kaliteli hammadde kullanımı
- Koruma seviyesi: IP 20
- Kolay montaj
- Kişileştirilebilir modül ve çerçeveler
- Geniş dekoratif çerçeve yelpazesi
- Yeni ürünlerle sürekli gelişen ürün yelpazesi



## FARK YARATAN DOKUNUŞLAR



## Stella | Alessa

### Renkler

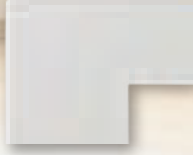

01 - BEYAZ

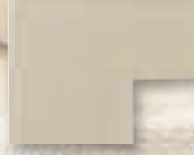

02 - KREM

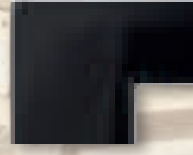

62 - METALİK SİYAH

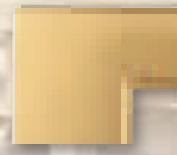

80 - ANTİK ALTIN



84 - SİYAH



86 - ANTRASİT



88 - SU YEŞİLİ



92 - ANTİK GÜMÜŞ



95 - FÜME



97 - SATEN BEJ

XX = Renk Kodlarının Karşılığıdır.

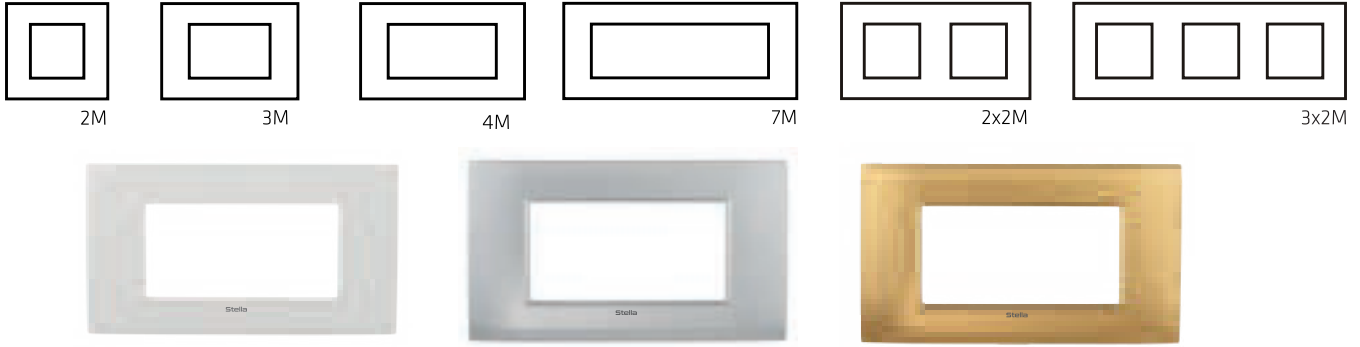

## Stella

Kod	Ürün Tanımı	Kutu Adedi	Koli Adedi	Beyaz/Krem Fiyat (₺)	Renkli Fiyat (₺)
<b>Çerçeveler</b>					
2440 800 12XX	Stella 2m Çerçeve	20	-	109,62	151,47
2440 800 13XX	Stella 3m Çerçeve	20	-	126,47	168,14
2440 800 14XX	Stella 4m Çerçeve	10	-	156,92	197,82
2440 800 17XX	Stella 7m Çerçeve	10	-	188,97	243,27
2430 800 12XX	Stella 2x2m Çerçeve	10	-	219,23	302,95
2430 800 13XX	Stella 3x2m Çerçeve	10	-	328,85	454,42

## Alessa

Kod	Ürün Tanımı	Kutu Adedi	Koli Adedi	Beyaz/Krem Fiyat (₺)	Renkli Fiyat (₺)
<b>Beyaz Fonlu Çerçeveler</b>					
2420 801 12XX	Alessa 2M Çerçeve - Beyaz Fonlu	20	-	135,93	187,82
2420 801 13XX	Alessa 3M Çerçeve - Beyaz Fonlu	20	-	156,82	208,49
2420 801 14XX	Alessa 4M Çerçeve - Beyaz Fonlu	10	-	194,58	245,30
2420 801 17XX	Alessa 7M Çerçeve - Beyaz Fonlu	10	-	234,32	301,65
2450 801 12XX	Alessa 2x2M Çerçeve - Beyaz Fonlu	10	-	271,85	375,66
2450 801 13XX	Alessa 3x2M Çerçeve - Beyaz Fonlu	10	-	407,77	563,48

Kod	Ürün Tanımı	Kutu Adedi	Koli Adedi	Beyaz/Krem Fiyat (₺)	Renkli Fiyat (₺)
<b>Siyah Fonlu Çerçeveler</b>					
2420 811 12XX	Alessa 2M Çerçeve - Siyah Fonlu	20	-	135,93	187,82
2420 811 13XX	Alessa 3M Çerçeve - Siyah Fonlu	20	-	156,82	208,49
2420 811 14XX	Alessa 4M Çerçeve - Siyah Fonlu	10	-	194,58	245,30
2420 811 17XX	Alessa 7M Çerçeve - Siyah Fonlu	10	-	234,32	301,65
2450 811 12XX	Alessa 2x2M Çerçeve - Siyah Fonlu	10	-	271,85	375,66
2450 811 13XX	Alessa 3x2M Çerçeve - Siyah Fonlu	10	-	407,77	563,48

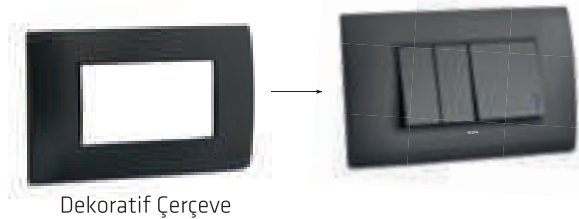
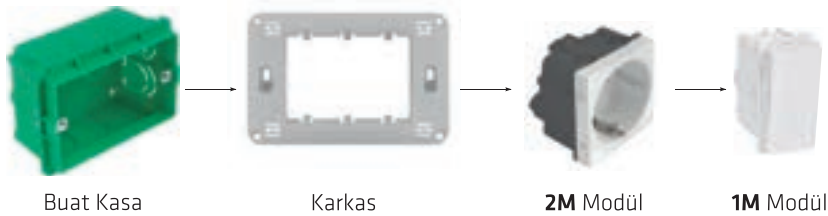

## MODÜLLER

Kod	Ürün Tanımı	Kutu Adedi	Koli Adedi	Fiyat (₺)
2400 701 0200	Anahtar (1M)	20	120	147,11
2400 703 0200	Vavien (1M)	20	120	147,11
2400 708 0200	Ara Vavien(Deviatör)(Permütatör)(1M)	20	120	233,81
2400 705 0200	Çift Kutuplu Anahtar (1M)	20	120	229,14
2400 707 0200	Light Butonu (1M)	20	120	147,11
2400 707 0200Z	Zil Butonu (1M)	20	120	147,11
2400 707 0200K	Kapı Otomatiği (1M)	20	120	147,11
2400 706 0200	Stor/Panjur (Jaluzi) (1M)	20	120	316,59



Kod	Ürün Tanımı	Kutu Adedi	Koli Adedi	Beyaz/Krem Fiyat (₺)	Renkli Fiyat (₺)
2400 900 02XX	Topraklı Priz (2M)	10	60	161,40	226,38
2400 905 02XX	Topraklı Priz (Çocuk Korumalı) (2M)	10	60	179,33	251,53
2400 910 02XX	Kapaklı Top.İli Priz (2M)	10	60	169,04	238,05
2400 911 02XX	Kapaklı Top.İli Priz (Çoc.Kor.) (2M)	10	60	187,83	264,50

Kod	Ürün Tanımı	Kutu Adedi	Koli Adedi	Beyaz/Krem Fiyat (₺)	Renkli Fiyat (₺)
2400 916 02XX	Ups ( Fransız) Priz (Çoc. Kor.) (2M)	10	60	215,95	253,93
2400 917 02XX	Ups (Fransız) Kapaklı Priz (2M)	10	60	215,19	301,83

Kod	Ürün Tanımı	Kutu Adedi	Koli Adedi	Beyaz/Krem Fiyat (₺)	Renkli Fiyat (₺)
2400 925 02XX	Universal Priz (1M)	20	120	151,13	166,75
2400 560 02XX	Universal Priz (2M)	10	60	567,58	721,80

Kod	Ürün Tanımı	Kutu Ad.	Koli Ad.	Beyaz/Krem Fiyat (₺)	Renkli Fiyat (₺)
2400 450 02XX	Stella Energy Saver Gecikmesiz Switch 220V (2M)	6	36	810,24	890,63
2400 452 02XX	Stella Energy Saver Gecikmeli Switch 220V (2M)	6	36	810,24	890,63
2400 462 02XX	Stella Energy Saver Gecikmesiz Switch 12V (2M)	6	36	1.295,90	1321,90
2400 464 02XX	Stella Energy Saver Gecikmeli Switch 12V (2M)	6	36	1.295,90	1321,90
2400 466 02XX	Stella Energy Saver Gecikmesiz 13.56 RF 12V (2M)	6	36	1.340,90	1455,10
2400 468 02XX	Stella Energy Saver Gecikmesiz 13.56 RF 12V (2M)	6	36	1.340,90	1455,10
2400 650 02XX	Alessa Energy Saver Gecikmesiz Switch 220V (2M)	6	36	810,24	890,63
2400 652 02XX	Alessa Energy Saver Gecikmeli Switch 220V (2M)	6	36	810,24	890,63
2400 662 02XX	Alessa Energy Saver Gecikmesiz Switch 12V (2M)	6	36	1.295,90	1321,90
2400 664 02XX	Alessa Energy Saver Gecikmeli Switch 12V (2M)	6	36	1.295,90	1321,90
2400 666 02XX	Alessa Energy Saver Gecikmesiz 13.56 RF 12V (2M)	6	36	1.340,90	1455,10
2400 668 02XX	Alessa Energy Saver Gecikmesiz 13.56 RF 12V (2M)	6	36	1.340,90	1455,10
2400 465 0201	4 Kanallı Röle Modülü	6	36	4.449,50	-

Kod	Ürün Tanımı	Kutu Adedi	Koli Adedi	Beyaz/Krem Fiyat (₺)	Renkli Fiyat (₺)
2400 550 02XX	İngiliz Tipi Priz (2M)	10	60	467,41	563,00

Kod	Ürün Tanımı	Kutu Adedi	Koli Adedi	Beyaz/Krem Fiyat (₺)	Renkli Fiyat (₺)
2400 469 02XX	USB + Tip-C Şarj Prizi PD 20W (2M)	10	60	1202,08	1.425,65

Kod	Ürün Tanımı	Kutu Adedi	Koli Adedi	Beyaz/Krem Fiyat (₺)	Renkli Fiyat (₺)
2400 920 02XX	İtalyan Priz (1M)	20	120	151,13	166,75

## MODÜLLER

Kod	Ürün Tanımı	Kutu Adedi	Koli Adedi	Beyaz/Krem Fiyat (₺)	Renkli Fiyat (₺)
2400 441 02XX	Dimmer 100 - 500w (1M) RC	20	120	1437,33	1.497,21
2400 541 02XX	Dimmer 100 - 500w (1M) RL	20	120	966,61	1.006,89



Kod	Ürün Tanımı	Kutu Adedi	Koli Adedi	Beyaz/Krem Fiyat (₺)	Renkli Fiyat (₺)
2400 442 02XX	Dimmer 100 - 500w (2M) RC	10	60	1524,23	1.587,74
2400 542 02XX	Dimmer 100 - 500w (2M) RL	10	60	1234,56	1.286,00



Kod	Ürün Tanımı	Kutu Adedi	Koli Adedi	Beyaz/Krem Fiyat (₺)	Renkli Fiyat (₺)
2400 171 02XX	Tv Prizi (Sonlu) (1M)	20	120	678,93	695,44
2400 170 02XX	Tv Prizi (Geçişli) (1M)	20	120	678,93	695,44



Kod	Ürün Tanımı	Kutu Adedi	Koli Adedi	Beyaz/Krem Fiyat (₺)	Renkli Fiyat (₺)
2400 172 02XX	Tv Prizi F Dişi (1M)	20	120	284,85	313,94



Kod	Ürün Tanımı	Kutu Adedi	Koli Adedi	Beyaz/Krem Fiyat (₺)	Renkli Fiyat (₺)
2400 125 02XX	Telefon Prizi (Cat3) (1M)	20	120	268,03	282,38
2400 140 02XX	Data Prizi (Cat6) (1M)	20	120	318,91	345,44



Kod	Ürün Tanımı	Kutu Adedi	Koli Adedi	Beyaz/Krem Fiyat (₺)	Renkli Fiyat (₺)
2400 482 02XX	RCA Çıkışı 2'li (1M)	20	120	247,28	546,40



Kod	Ürün Tanımı	Kutu Adedi	Koli Adedi	Beyaz/Krem Fiyat (₺)	Renkli Fiyat (₺)
2400 121 02XX	Kör Kapak (1M)	20	120	24,84	52,73



Kod	Ürün Tanımı	Kutu Adedi	Koli Adedi	Fiyat (₺)
2400 000 0001	Mavi Lamba	50	-	81,34



## TUŞLAR

Kod	Ürün Tanımı	Kutu Adedi	Koli Adedi	Beyaz/Krem Fiyat (₺)	Renkli Fiyat (₺)
2410 701 01XX	1M Anahtar Tuş	40	-	20,86	46,40
2410 701 02XX	2M Anahtar Tuş	20	-	29,55	61,20

Kod	Ürün Tanımı	Kutu Adedi	Koli Adedi	Beyaz/Krem Fiyat (₺)	Renkli Fiyat (₺)
2410 703 01XX	1M Vavien Tuş	40	-	20,86	46,40
2410 703 02XX	2M Vavien Tuş	20	-	29,55	61,20

Kod	Ürün Tanımı	Kutu Adedi	Koli Adedi	Beyaz/Krem Fiyat (₺)	Renkli Fiyat (₺)
2410 708 01XX	1M Ara Vavien Tuş	40	-	20,86	46,40
2410 708 02XX	2M Ara Vavien Tuş	20	-	29,55	61,20

Kod	Ürün Tanımı	Kutu Adedi	Koli Adedi	Beyaz/Krem Fiyat (₺)	Renkli Fiyat (₺)
2410 707 01XX	1M Çağırma Light Tuş	40	-	20,86	46,40
2410 707 02XX	2M Çağırma Light Tuş	20	-	29,55	61,20

Kod	Ürün Tanımı	Kutu Adedi	Koli Adedi	Beyaz/Krem Fiyat (₺)	Renkli Fiyat (₺)
2410 707 01XXZ	1M Zil Anahtar Tuş	40	-	20,86	46,40
2410 707 02XXZ	2M Zil Anahtar Tuş	20	-	29,55	61,20

Kod	Ürün Tanımı	Kutu Adedi	Koli Adedi	Beyaz/Krem Fiyat (₺)	Renkli Fiyat (₺)
2410 707 01XXK	1M Kapı Otomatığı Tuş	40	-	20,86	46,40
2410 707 02XXK	2M Kapı Otomatığı Tuş	20	-	29,55	61,20

Kod	Ürün Tanımı	Kutu Adedi	Koli Adedi	Beyaz/Krem Fiyat (₺)	Renkli Fiyat (₺)
2410 715 01XX	1M Işıklı Anahtar Tuş	40	-	20,86	46,40
2410 715 02XX	2M Işıklı Anahtar Tuş	20	-	29,55	61,20

Kod	Ürün Tanımı	Kutu Adedi	Koli Adedi	Beyaz/Krem Fiyat (₺)	Renkli Fiyat (₺)
2410 716 01XX	1M Işıklı Vavien Anahtar Tuş	40	-	20,86	46,40
2410 716 02XX	2M Işıklı Vavien Anahtar Tuş	20	-	29,55	61,20

Kod	Ürün Tanımı	Kutu Adedi	Koli Adedi	Beyaz/Krem Fiyat (₺)	Renkli Fiyat (₺)
2410 717 01XX	1M Çağırma Light Işıklı Tuş	40	-	20,86	46,40
2410 717 02XX	2M Çağırma Light Işıklı Tuş	20	-	29,55	61,20

Kod	Ürün Tanımı	Kutu Adedi	Koli Adedi	Beyaz/Krem Fiyat (₺)	Renkli Fiyat (₺)
2410 717 01XXZ	1M Işıklı Zil Anahtar Tuş	40	-	20,86	46,40
2410 717 02XXZ	2M Işıklı Zil Anahtar Tuş	20	-	29,55	61,20

Kod	Ürün Tanımı	Kutu Adedi	Koli Adedi	Beyaz/Krem Fiyat (₺)	Renkli Fiyat (₺)
2410 717 01XXK	1M Işıklı Kapı Anahtar Tuş	40	-	20,86	46,40
2410 717 02XXK	2M Işıklı Kapı Anahtar Tuş	20	-	29,55	61,20

Kod	Ürün Tanımı	Kutu Adedi	Koli Adedi	Beyaz/Krem Fiyat (₺)	Renkli Fiyat (₺)
2410 706 01XX	1M Jaluzi Tuş	40	-	20,86	46,40



## TAŞIYICI KAİDELER

Kod	Ürün Tanımı	Kutu Adedi	Koli Adedi	Fiyat (₺)
2400 500 0217	Taşıyıcı Kaide (2M)	10	-	51,29
2400 500 0317	Taşıyıcı Kaide (3M)	10	-	53,12
2400 500 0417	Taşıyıcı Kaide (4M)	10	-	59,56
2400 500 0717	Taşıyıcı Kaide (7M)	10	-	91,25

## SIVA ALTI BUAT KASALAR

Kod	Ürün Tanımı	Kutu Adedi	Koli Adedi	Fiyat (₺)
001 046 180101 00 12	Çift Kilitlemeli Geçmeli Derin Kasa (2M)	300	-	34,10
2400 812 1315	Sıva Altı Buat Kasa (3M)	165	-	51,07
2400 812 1415	Sıva Altı Buat Kasa (4M)	135	-	68,72
2400 812 1715	Sıva Altı Buat Kasa (7M)	90	-	86,52



## ALÇIPAN KASA

Kod	Ürün Tanımı	Kutu Adedi	Koli Adedi	Fiyat (₺)
2400 813 1312	Alçıpan Kasa (3M)	180	-	88,38
2400 813 1412	Alçıpan Kasa (4M)	150	-	111,92
2400 813 1712	Alçıpan Kasa (7M)	114	-	180,61



## SIVA ALTI BAĞLANTI APARATI

Kod	Ürün Tanımı	Kutu Adedi	Koli Adedi	Fiyat (₺)
2400 818 0011	Sıva Altı Bağlantı Aparatı	40	-	25,22



# Ritä



Modern tasarımlar,  
kusursuz çözümler...



VİDALI TİP																			
	2220 401 02XX Anahtar	2220 402 02XX Komütatör	2220 403 02XX Vavien (iki Yollu Anahtar)	2220 404 02XX Komütatör Vavien	2220 405 02XX Çift Kutuplu Anahtar	2220 406 02XX Jaluzi Anahtar	2220 407 02XX Çağırma	2220 407 02XXK Kapı Otomatiji Anahtar											
2220 407 02XXZ Zil Anahtar	2220 408 02XX Deviatör(Ara Vavien)	2220 409 02XX Üçlü Anahtar	2220 411 02XX Şofben Anahtar	2220 415 02XX Işıkli Anahtar (220V)	2220 416 02XX Işıkli Vavien (220V)	2220 417 02XX Işıkli Çağırma (220V)	2220 418 02XX Işıkli Etik. Anahtar (220V)	2220 419 02XX Işıkli Etik. Çağırma (220V)											
2220 422 02XX Işıkli Zil Etik. Çağırma (12V)	2220 425 02XX Tek Tuşlu Jaluzi Anahtar (Vidalı)	2220 426 02XX Işıkli Komütatör	2220 436 02XX Jaluzi Anahtar (Yaysız - Vidalı)	KLİPSLİ TİP (KOLAY BAĞLANTI)		2220 401 01XX Anahtar	2220 402 01XX Komütatör	2220 403 01XX Vavien (iki Yollu Anahtar)	2220 404 01XX Komütatör Vavien										
2220 405 01XX Çift Kutuplu Anahtar	2220 406 01XX Jaluzi Anahtar	2220 407 01XX Çağırma	2220 407 01XXK Kapı Otomatiji Anahtar	2220 407 01XXZ Zil Anahtar	2220 408 01XX Deviatör(Ara Vavien)	2220 409 01XX Üçlü Anahtar	2220 415 01XX Işıkli Anahtar (220V)	2220 416 01XX Işıkli Vavien (220V)											
2220 417 01XX Işıkli Çağırma (220V)	2220 418 01XX Işıkli Etik. Anahtar (220V)	2220 419 01XX Işıkli Etik. Çağırma (220V)	2220 422 01XX Işıkli Zil Etik. Çağırma (12V)	2220 426 01XX Işıkli Komütatör	2220 436 01XX Jaluzi Anahtar (Yaysız - Klipsli)														
2220 447 02XX RC Dimmer 325W	ELEKTRONİK		2220 450 01XX Energy Saver G.sız Işıkli	2220 452 01XX Energy Saver Gecikmeli Işıkli	2220 470 02XX Müzik Yayın Anahtar	2220 480 01XX Hoparlör Prizi	2220 485 02XX Uyarı Zili	2220 495 02XX Hareket Sensörü											
2220 600 02XX Tonraklı Priz	2220 601 02XX Tooraksız Priz	2220 605 02XX Topraklı Priz (Ç.K.)	2220 606 02XX Topraksız Priz (Ç.K.)	2220 610 02XX Kapaklı Topraklı Priz	2220 611 02XX Kapaklı Topraklı Priz (Ç.K.)	2220 615 02XX Ups (Fransız) Prizi	2220 616 02XX Ups (Fransız) Prizi (Ç.K.)	2220 617 02XX Ups Kapaklı (Fransız) Priz											
2220 618 02XX Ups Kapaklı (Fr.) Priz (Ç.K.)	2220 448 01XX Tekli Usb Şarj Prizi	2220 449 01XX İkili Usb Şarj Prizi	2220 200 02XX İkili Topraklı Priz Porselen	2220 201 02XX İkili Tooraksız Priz Porselen	2220 202 02XX İkili Tooraklı Priz	2220 203 02XX İkili Tooraksız Priz													
2220 215 01XX	2220 619 02XX İkili Usb (2,4A) Topraklı Priz	2220 629 02XX Usb + Type C'li Topraklı Priz	İLETİŞİM		2220 125 01XX Telefon Prizi 1Xrj12 (Cat3)	2220 126 01XX Telefon Prizi 2Xrj12 (Cat3)	2220 128 01XX Etiketli TİF Data Priz (Kon.süz)	2220 135 01XX Data Prizi 1*Rj45 (Kon.süz)	2220 136 01XX Data Prizi 1*Rj45 (Cat5e)										
2220 137 01XX Data Prizi 2*Rj45 (Kon.süz)	2220 139 01XX TİF Data Priz (Rj12 Cat3 + Cat5e)	2220 138 01XX Data Prizi 2*Rj45 (Cat5e)	2220 140 01XX Data Prizi 1*Rj45 (Cat6)	2220 141 01XX Data Prizi 2*Rj45 (Cat6)	2220 455 01XX Data Prizi 1*Usb	2220 456 01XX Data Prizi 2*Usb	2220 457 01XX Data Prizi 1*Hdmi	2220 458 01XX Data Prizi 2*Hdmi											
2220 459 01XX Data Prizi 1*Usb/1*Hdmi	2220 460 01XX VGA Priz	2220 147 01XX Tek Çıkışlı Fiber Optik Priz	2220 461 01XX İki Çıkışlı Fiber Optik Priz	2220 121 02XX Kör Kapak															
2220 167 01XX Sat Prizi (Sonlu)	2220 170 01XX Tv Prizi (Geçişli) 11DB	2220 171 01XX Tv Prizi (Sonlu)	2220 172 01XX Tv Prizi F Dışı																



NATURAL



01 - BEYAZ



02 - KREM

AHŞAP



56 - KIRAZ



57 - CEVİZ



58 - MEŞE

METALİK



80 - A.ALTIN

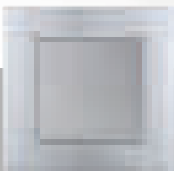

82 - İNOX

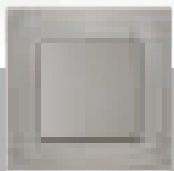

83 - TİTANYUM



84 - SİYAH



85 - DORE

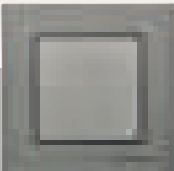

86 - ANTRASİT

□□□□□□ □

PASTEL

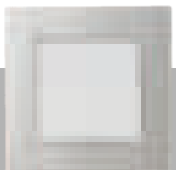

03 - GRİ

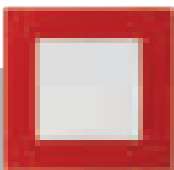

04 - KIRMIZI



06 - TURUNCU

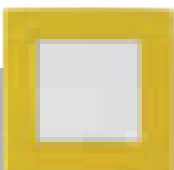

08 - SARI

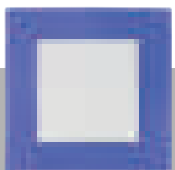

09 - LACİVERT

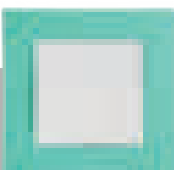

10 - YEŞİL

□□□□□□ □□

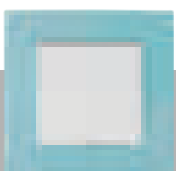

12 - MAVİ

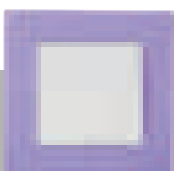

25 - MOR

Kod	Ürün Tanımı	Kutu Adedi	Koli Adedi	Beyaz/Krem Fiyat (₺)	Metalik Fiyat (₺)	Ahşap Fiyat (₺)
-----	-------------	------------	------------	----------------------	-------------------	-----------------

**Anahtar Grubu Vidalı Tip**

2200 401 02XX	Mek+Tuş Anahtar (Vidalı)	12	120	100,50	130,69	143,76
2200 402 02XX	Mek+Tuş Komütatör (Vidalı)	12	120	132,94	166,74	183,42
2200 403 02XX	Mek+Tuş Vavien (İki Yollu Anahtar)(Vidalı)	12	120	130,69	153,22	168,54
2200 404 02XX	Mek+Tuş Komütatör Vavien (Vidalı)	12	120	226,35	265,89	292,47
2200 405 02XX	Mek+Tuş Çift Kutuplu Anahtar (Vidalı)	12	120	148,74	180,26	198,29
2200 406 02XX	Mek+Tuş Jaluzi Anahtar (Vidalı)	12	120	191,18	225,33	247,86
2200 407 02XX	Mek+Tuş Çağırma (Vidalı)	12	120	105,00	146,46	161,11
2200 407 02XXK	Mek+Tuş Kapı Otomatığı Anahtar (Vidalı)	12	120	105,00	146,46	161,11
2200 407 02XXZ	Mek+Tuş Zil Anahtar (Vidalı)	12	120	105,00	146,46	161,11
2200 408 02XX	Mek+Tuş Deviatör(Ara Vavien)(Vidalı)	12	120	209,06	270,39	297,43
2200 409 02XX	Mek+Tuş Üçlü Anahtar (Vidalı)	12	120	207,30	261,38	287,52
2200 411 02XX	Mek+Tuş Şofben Anahtar (Vidalı)	12	120	202,19	274,90	302,39
2200 415 02XX	Mek+Tuş Işıklı Anahtar (220V) (Vidalı)	12	120	191,14	229,83	252,82
2200 416 02XX	Mek+Tuş Işıklı Vavien (220V) (Vidalı)	12	120	244,21	279,41	307,35
2200 417 02XX	Mek+Tuş Işıklı Çağırma (220V)(Vidalı)	12	120	200,86	292,92	322,22
2200 418 02XX	Mek+Tuş Işıklı Etik. Anahtar (220V)(Vidalı)	12	120	220,22	252,37	277,60
2200 419 02XX	Mek+Tuş Işıklı Etik. Çağırma (220V)(Vidalı)	12	120	214,18	306,44	337,09
2200 422 02XX	Mek+Tuş Işıklı Zil Etik. Çağırma (12V)(Vidalı)	12	120	280,56	369,54	406,49
2200 425 02XX	Mek+Tuş Tek Tuşlu Jaluzi Anahtar (Vidalı)	12	120	211,81	315,46	347,00
2200 426 02XX	Mek+Tuş Işıklı Komütatör (Vidalı)	12	120	250,04	261,38	282,56
2200 436 02XX	Mek+Tuş Jaluzi Anahtar (Yaysız)(Vidalı)	12	120	205,25	292,92	322,22

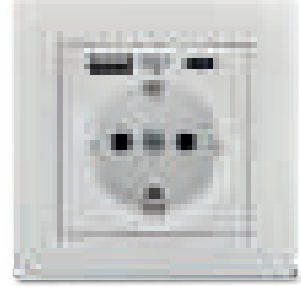

\* Çoklu çerçeve ile kullanılamaz.

**Anahtar Grubu Klipsli Tip (Kolay Bağlantı)**

2200 401 01XX	Mek+Tuş Anahtar (Klipsli)	12	120	100,50	130,69	143,76
2200 402 01XX	Mek+Tuş Komütatör (Klipsli)	12	120	132,94	166,74	183,42
2200 403 01XX	Mek+Tuş Vavien (İki Yollu Anahtar)(Klipsli)	12	120	130,69	153,22	168,54
2200 404 01XX	Mek+Tuş Komütatör Vavien (Klipsli)	12	120	226,35	265,89	292,47
2200 405 01XX	Mek+Tuş Çift Kutuplu Anahtar (Klipsli)	12	120	148,74	180,26	198,29
2200 406 01XX	Mek+Tuş Jaluzi Anahtar (Klipsli)	12	120	191,18	225,33	247,86
2200 407 01XX	Mek+Tuş Çağırma (Klipsli)	12	120	105,00	146,46	161,11
2200 407 01XXK	Mek+Tuş Kapı Otomatığı Anahtar (Klipsli)	12	120	105,00	146,46	161,11
2200 407 01XXZ	Mek+Tuş Zil Anahtar (Klipsli)	12	120	105,00	146,46	161,11
2200 408 01XX	Mek+Tuş Deviatör(Ara Vavien)(Klipsli)	12	120	209,06	270,39	297,43
2200 409 01XX	Mek+Tuş Üçlü Anahtar (Klipsli)	12	120	207,30	261,38	287,52
2200 415 01XX	Mek+Tuş Işıklı Anahtar (220V) (Klipsli)	12	120	191,14	229,83	252,82
2200 416 01XX	Mek+Tuş Işıklı Vavien (220V) (Klipsli)	12	120	244,21	279,41	307,35
2200 417 01XX	Mek+Tuş Işıklı Çağırma (220V)(Klipsli)	12	120	200,86	292,92	322,22
2200 418 01XX	Mek+Tuş Işıklı Etik. Anahtar (220V)(Klipsli)	12	120	220,22	252,37	277,60
2200 419 01XX	Mek+Tuş Işıklı Etik. Çağırma (220V)(Klipsli)	12	120	214,18	306,44	337,09
2200 422 01XX	Mek+Tuş Işıklı Zil Etik. Çağırma (12V)(Klipsli)	12	120	280,56	369,54	406,49
2200 426 01XX	Mek+Tuş Işıklı Komütatör (Klipsli)	12	120	250,04	261,38	282,56
2200 436 01XX	Mek+Tuş Jaluzi Anahtar (Yaysız)(Klipsli)	12	120	205,25	292,92	322,22

**Dimmer Grubu**

2200 440 02XX	Mek+Tuş RL Işıklı Dimmer 600W	8	80	585,85	653,45	849,48
2200 444 02XX	Mek+Tuş RL Işıklı Dimmer 1000W	8	80	630,91	892,29	1.009,46
2200 447 02XX	Mek+Tuş RC Dimmer 325W	8	80	1.351,96	2.163,14	2.379,45

**Elektronik Grubu**

2200 450 01XX	Mek+Tuş Energy Saver G.siz Işıklı	8	80	721,05	770,62	886,21
2200 452 01XX	Mek+Tuş Energy Saver Gecikmeli Işıklı	8	80	721,05	811,18	932,85
2200 454 01XX	Mek+Tuş Temassız	12	120	1.577,29	1.757,55	1.933,30
2200 470 02XX	Mek+Tuş Müzik Yayın Anahtar	8	80	1.081,57	1.135,65	1.305,99
2200 480 01XX	Mek+Tuş Hoparlör Prizi	8	80	225,33	315,46	362,78
2200 485 02XX	Mek+Tuş Uyarı Zili	8	80	1.577,29	1.712,48	1.969,36
2200 495 02XX	Mek+Tuş Hareket Sensörü	8	80	1.577,29	1.712,48	1.969,36

**Priz Grubu**

2200 600 02XX	Mek+Tuş Topraklı Priz	12	120	127,53	166,74	191,75
2200 601 02XX	Mek+Tuş Topraksız Priz	12	120	110,41	148,72	171,02
2200 605 02XX	Mek+Tuş Topraklı Priz (Ç.K.)	12	120	162,24	202,79	233,21
2200 606 02XX	Mek+Tuş Topraksız Priz (Ç.K.)	12	120	144,21	157,73	181,39
2200 610 02XX	Mek+Tuş Kapaklı Topraklı Priz	12	120	153,22	184,77	212,48
2200 611 02XX	Mek+Tuş Kapaklı Topraklı Priz (Ç.K.)	12	120	171,25	225,33	259,13
2200 615 02XX	Mek+Tuş Ups (Fransız) Prizi	12	120	180,26	220,82	253,94
2200 616 02XX	Mek+Tuş Ups (Fransız) Prizi (Ç.K.)	12	120	191,53	261,38	300,59
2200 617 02XX	Mek+Tuş Ups Kapaklı (Fransız) Priz	12	120	175,75	234,34	269,49
2200 618 02XX	Mek+Tuş Ups Kapaklı (Fr.) Priz (Ç.K.)	12	120	193,33	283,91	326,50
2200 200 02XX	Mek+Tuş İkili Topraklı Priz Porselen	5	50	290,03	405,59	466,43
2200 201 02XX	Mek+Tuş İkili Topraksız Priz Porselen	5	50	247,01	301,94	347,23
2200 202 02XX	Mek+Tuş İkili Topraklı Priz	5	50	247,86	270,39	310,95
2200 203 02XX	Mek+Tuş İkili Topraksız Priz	5	50	229,19	247,86	285,04
2200 215 02XX	Mek+Tuş İkili Ups Priz	5	50	243,53	270,39	310,95
2200 448 01XX	Mek+Tuş Tekli Usb Şarj Prizi	5	50	473,19	563,32	647,81
2200 449 01XX	Mek+Tuş İkili Usb Şarj Prizi	5	50	576,84	630,91	769,72
2200 469 01XX	Mek+Tuş İkili Usb + Type-C Şarj Prizi	5	50	634,52	675,07	820,05
2220 619 02XX	İkili Usb Topraklı Priz (Çerçeve Dahil)	8	-	630,91	1.036,50	1.191,98
2220 629 02XX	Rita Usb +Tip-C li Topraklı Priz (Çerçeve Dahil)	8	-	700,00	1.059,04	1.217,89

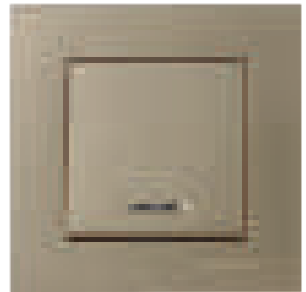

Kod	Ürün Tanımı	Kutu Adedi	Koli Adedi	Beviz/Krem Fiyat (₺)	Metalik Fiyat (₺)	Ahşap Fiyat (₺)
-----	-------------	------------	------------	----------------------	-------------------	-----------------

### İletişim Grubu

2200 125 01XX	Mek+Tuş Telefon Prizi 1Xrj12 (Cat3)	12	120	135,20	189,27	246,06
2200 126 01XX	Mek+Tuş Telefon Prizi 2Xrj12 (Cat3)	12	120	225,33	279,41	363,23
2200 128 01XX	Mek+Tuş Etiketli Tlf Data Priz (Kon.süz)	12	120	121,68	135,20	175,75
2200 135 01XX	Mek+Tuş Data Prizi 1*Rj45 (Kon.süz)	12	120	108,16	121,68	160,61
2200 136 01XX	Mek+Tuş Data Prizi 1*Rj45 (Cat5e)	12	120	383,06	401,08	521,41
2200 137 01XX	Mek+Tuş Data Prizi 2*Rj45 (Kon.süz)	12	120	112,66	126,18	164,04
2200 138 01XX	Mek+Tuş Data Prizi 2*Rj45 (Cat5e)	12	120	540,78	585,85	761,60
2200 139 01XX	Mek+Tuş Tlf Data Priz (Rj12 Cat3 + Cat5e)	12	120	473,19	495,72	644,43
2200 140 01XX	Mek+Tuş Data Prizi 1*Rj45 (Cat6)	12	120	383,06	401,08	521,41
2200 141 01XX	Mek+Tuş Data Prizi 2*Rj45 (Cat6)	12	120	540,78	585,85	761,60
2200 142 01XX	Mek+Tuş Tlf Data Priz (Rj12 Cat6)	12	120	473,19	495,72	644,43
2200 455 01XX	Mek+Tuş Data Prizi 1*Usb	12	120	337,99	360,52	468,68
2200 456 01XX	Mek+Tuş Data Prizi 2*Usb	12	120	567,82	630,91	820,19
2200 457 01XX	Mek+Tuş Data Prizi 1*Hdmi	12	120	441,64	495,72	644,43
2200 458 01XX	Mek+Tuş Data Prizi 2*Hdmi	12	120	793,15	878,77	1.142,41
2200 459 01XX	Mek+Tuş Data Prizi 1*Usb/1*Hdmi	12	120	901,31	1.036,50	1.347,45
2200 460 01XX	Mek+Tuş VGA Priz	12	120	901,31	1.036,50	1.347,45
2200 147 01XX	Mek+Tuş Bir Çıkışlı Fiber Optik Priz (RJ45)	12	120	220,82	292,92	380,80
2200 461 01XX	Mek+Tuş İki Çıkışlı Fiber Optik Priz	12	120	337,99	405,59	527,26
2200 121 02XX	Mek+Tuş Kör Kapak	12	120	78,86	126,18	164,04

### TV / SAT Grubu

2200 156 02XX	Mek+Tuş Tv-Sat Prizi (Geçişli) 4DB/F Kon.	12	120	721,05	766,11	842,72
2200 157 02XX	Mek+Tuş Tv-Sat Prizi (Sonlu)	12	120	721,05	766,11	842,72
2200 166 01XX	Mek+Tuş Sat Prizi (Geçişli) 4DB/F Kon.	12	120	630,91	675,98	743,58
2200 167 01XX	Mek+Tuş Sat Prizi (Sonlu)	12	120	630,91	675,98	743,58
2200 170 01XX	Mek+Tuş Tv Prizi (Geçişli) 11DB	12	120	202,79	225,33	270,39
2200 171 01XX	Mek+Tuş Tv Prizi (Sonlu)	12	120	202,79	225,33	270,39
2200 172 01XX	Mek+Tuş Tv Prizi F Dişi	12	120	112,66	135,20	148,72

### Çerçeveler

2220 800 11XX	Tekli Çerçeve	20	400	13,52	56,33	61,96
2220 800 12XX	İkili Yatay Çerçeve	10	200	72,10	114,92	126,41
2220 800 13XX	Üçlü Yatay Çerçeve	10	50	101,40	162,24	178,46
2220 800 14XX	Dörtlü Yatay Çerçeve	10	50	130,69	202,79	223,07
2220 800 15XX	Beşli Yatay Çerçeve	10	50	166,74	247,86	272,65
2220 800 16XX	Altılı Yatay Çerçeve	10	50	193,78	292,92	322,22
2220 800 22XX	İkili Dikey Çerçeve	10	50	72,10	90,13	99,14
2220 800 23XX	Üçlü Dikey Çerçeve	10	50	101,40	114,92	143,65
2220 800 24XX	Dörtlü Dikey Çerçeve	10	50	130,69	162,24	178,46
2220 800 25XX	Beşli Dikey Çerçeve	10	50	166,74	225,33	247,86
2220 800 26XX	Altılı Dikey Çerçeve	10	50	193,78	247,86	272,65
2220 820 12XX	İkili Priz Çerçeve	12	60	45,07	90,13	99,14
2100 000 11XX	Sıva Üstü Kasa	12	60	67,60	112,66	129,56
2200 000 11XX	Sıva Üstü Anahtar Kasası (Geçmeli)	-	-	110,41	166,74	191,75
2200 800 00XX	Telefon Tutucu	24	240	33,80	-	-
2200 000 0001	IP44 Kapaklı Priz Conta	24	120	33,80	-	-

### RİTA PASTEL

#### Çerçeveler

Çerçeve	Kutu Adedi	Koli Adedi	Pastel Fiyat (₺)
2220 800 11XX	20	400	18,03
2220 800 12XX	10	200	94,64
2220 800 13XX	10	50	135,20
2220 800 14XX	10	50	162,24
2220 800 15XX	10	50	189,27
2220 800 16XX	10	50	220,82
2220 800 22XX	10	50	94,64
2220 800 23XX	10	50	135,20
2220 800 24XX	10	50	162,24
2220 800 25XX	10	50	189,27
2220 800 26XX	10	50	220,82

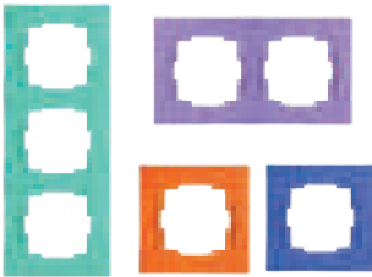
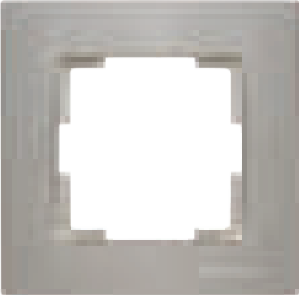
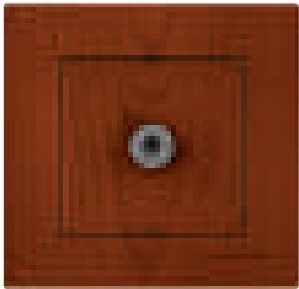
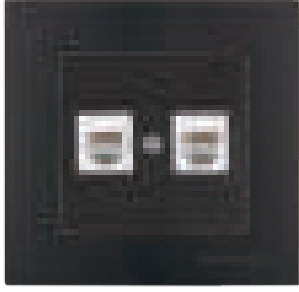

Sıva üstü kasa uygulaması ile istediğiniz kadar "Anahtar Priz Uygulaması" yapabilirsiniz.



# Elitra | Plus

Uyum ve zarafet  
bir arada...



## Elitra | Plus

### Elitra Glass

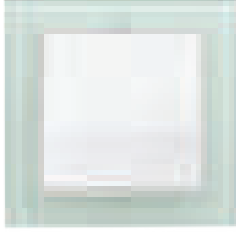

XXX-811

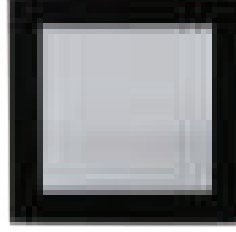

XXX-814

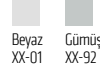

Beyaz  
XX-01

Gümüş  
XX-92

## BEYAZ / SİYAH

Kod	Ürün Tanımı	Kutu Adedi	Fiyat (₺)
2170 XXX 11XX	Tekli Çerçeve	10	574,79
2170 XXX 12XX	Yatay İkili Çerçeve	10	1.346,67
2170 XXX 13XX	Yatay Üçlü Çerçeve	10	2.267,82
2170 XXX 14XX	Yatay Dörtlü Çerçeve	10	2.704,72
2170 XXX 15XX	Yatay Beşli Çerçeve	10	4.063,64
2170 XXX 22XX	Dikey İkili Çerçeve	10	1.346,67
2170 XXX 23XX	Dikey Üçlü Çerçeve	10	2.267,82
2170 XXX 24XX	Dikey Dörtlü Çerçeve	10	2.704,72
2170 XXX 25XX	Dikey Beşli Çerçeve	10	4.063,64

## Elitra Chrome

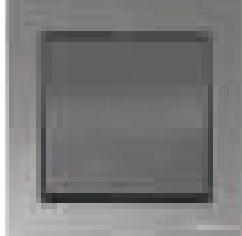

XXX-821

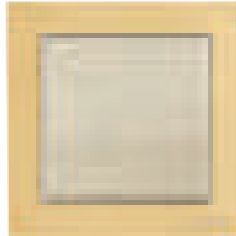

XXX-822

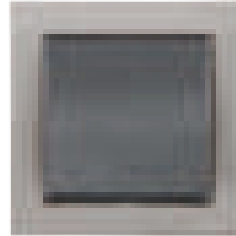

XXX-824

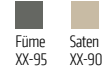

Fırme  
XX-95

Saten  
XX-90

## KROM / PASLANMAZ ÇELİK / ALTIN

Kod	Ürün Tanımı	Kutu Adedi	Fiyat (₺)
2170 XXX 11XX	Tekli Çerçeve	10	1.125,03
2170 XXX 12XX	Yatay İkili Çerçeve	10	1.780,90
2170 XXX 13XX	Yatay Üçlü Çerçeve	10	2.358,12
2170 XXX 14XX	Yatay Dörtlü Çerçeve	10	2.650,30
2170 XXX 15XX	Yatay Beşli Çerçeve	10	3.299,92
2170 XXX 16XX	Yatay Altılı Çerçeve	10	4.368,99
2170 XXX 22XX	Dikey İkili Çerçeve	10	1.780,90
2170 XXX 23XX	Dikey Üçlü Çerçeve	10	2.358,12
2170 XXX 24XX	Dikey Dörtlü Çerçeve	10	2.650,30
2170 XXX 25XX	Dikey Beşli Çerçeve	10	3.299,92
2170 XXX 26XX	Dikey Altılı Çerçeve	10	4.368,99

## Elitra | Plus

### Elitra Chrome



XXX-825

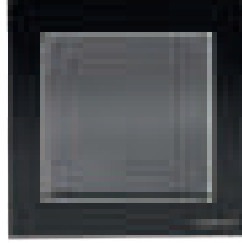

XXX-825



## GÜMÜŞ - PARLAK FÜME

Kod	Ürün Tanımı	Kutu Adedi	Fiyat (₺)
2170 825 11XX	Tekli Çerçeve	10	773,81
2170 825 12XX	Yatay İkili Çerçeve	10	1.353,57
2170 825 13XX	Yatay Üçlü Çerçeve	10	1.922,70
2170 825 14XX	Yatay Dörtlü Çerçeve	10	2.378,50
2170 825 15XX	Yatay Beşli Çerçeve	10	2.707,06
2170 825 16XX	Yatay Altılı Çerçeve	10	3.144,11
2170 825 22XX	Dikey İkili Çerçeve	10	1.353,57
2170 825 23XX	Dikey Üçlü Çerçeve	10	1.922,70
2170 825 24XX	Dikey Dörtlü Çerçeve	10	2.378,50
2170 825 25XX	Dikey Beşli Çerçeve	10	2.707,06
2170 825 26XX	Dikey Altılı Çerçeve	10	3.144,11

### Elitra Chrome

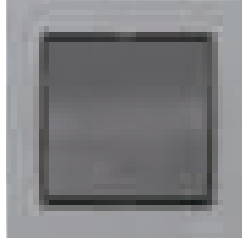

XXX-827

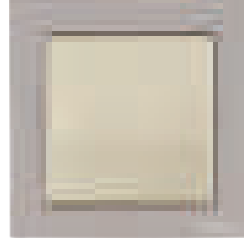

XXX-828



## MAT ALÜMİNYUM - MAT SATEN

Kod	Ürün Tanımı	Kutu Adedi	Fiyat (₺)
2170 XXX 11XX	Tekli Çerçeve	10	727,74
2170 XXX 12XX	Yatay İkili Çerçeve	10	1.139,69
2170 XXX 13XX	Yatay Üçlü Çerçeve	10	1.509,61
2170 XXX 14XX	Yatay Dörtlü Çerçeve	10	1.856,62
2170 XXX 15XX	Yatay Beşli Çerçeve	10	2.347,14
2170 XXX 16XX	Yatay Altılı Çerçeve	10	3.131,40
2170 XXX 22XX	Dikey İkili Çerçeve	10	1.139,69
2170 XXX 23XX	Dikey Üçlü Çerçeve	10	1.509,61
2170 XXX 24XX	Dikey Dörtlü Çerçeve	10	1.856,62
2170 XXX 25XX	Dikey Beşli Çerçeve	10	2.347,14
2170 XXX 26XX	Dikey Altılı Çerçeve	10	3.131,40

## KAYIN / KIRAZ / VENGE



Kod	Ürün Tanımı	Kutu Adedi	Fiyat (₺)
2170 XXX 11XX	Tekli Çerçeve	10	704,28
2170 XXX 12XX	Yatay İkili Çerçeve	10	1.133,74
2170 XXX 13XX	Yatay Üçlü Çerçeve	10	1.636,86
2170 XXX 14XX	Yatay Dörtlü Çerçeve	10	2.062,10
2170 XXX 15XX	Yatay Beşli Çerçeve	10	2.550,22
2170 XXX 22XX	Dikey İkili Çerçeve	10	1.133,74
2170 XXX 23XX	Dikey Üçlü Çerçeve	10	1.636,86
2170 XXX 24XX	Dikey Dörtlü Çerçeve	10	2.062,10
2170 XXX 25XX	Dikey Beşli Çerçeve	10	2.550,22

## Elitra Marble

## BLACK QUARTZ / SAND STONE



Kod	Ürün Tanımı	Kutu Adedi	Fiyat (₺)
2170 XXX 11XX	Tekli Çerçeve	10	854,70
2170 XXX 12XX	Yatay İkili Çerçeve	10	986,14
2170 XXX 13XX	Yatay Üçlü Çerçeve	10	1.503,53
2170 XXX 14XX	Yatay Dörtlü Çerçeve	10	1.957,77
2170 XXX 15XX	Yatay Beşli Çerçeve	10	2.420,79
2170 XXX 22XX	Dikey İkili Çerçeve	10	986,14
2170 XXX 23XX	Dikey Üçlü Çerçeve	10	1.503,53
2170 XXX 24XX	Dikey Dörtlü Çerçeve	10	1.957,77
2170 XXX 25XX	Dikey Beşli Çerçeve	10	2.420,79

## Elitra Ale

## NATURAL / SATEN / MAT FÜME



Kod	Ürün Tanımı	Kutu Adedi	Fiyat (₺)
2170 XXX 11XX	Tekli Çerçeve	10	567,38
2170 XXX 12XX	Yatay İkili Çerçeve	10	973,51
2170 XXX 13XX	Yatay Üçlü Çerçeve	10	1.600,26
2170 XXX 14XX	Yatay Dörtlü Çerçeve	10	2.003,83
2170 XXX 15XX	Yatay Beşli Çerçeve	10	2.476,48
2170 XXX 16XX	Yatay Altılı Çerçeve	10	4.612,92
2170 XXX 22XX	Dikey İkili Çerçeve	10	973,51
2170 XXX 23XX	Dikey Üçlü Çerçeve	10	1.600,26
2170 XXX 24XX	Dikey Dörtlü Çerçeve	10	2.003,83
2170 XXX 25XX	Dikey Beşli Çerçeve	10	2.476,48
2170 XXX 26XX	Dikey Altılı Çerçeve	10	4.612,92

Kod	Ürün Tanımı	Kutu Adedi	Fiyat (₺)
<b>Anahtar Grubu Vidalı Tip</b>			
2270 401 02XX	Mek+Tuş Anahtar	12	130,69
2270 402 02XX	Mek+Tuş Komütatör	12	166,74
2270 403 02XX	Mek+Tuş Vavien (iki Yollu Anahtar)	12	153,22
2270 404 02XX	Mek+Tuş Komütatör Vavien	12	265,89
2270 405 02XX	Mek+Tuş Çift Kutuplu Anahtar	12	180,26
2270 406 02XX	Mek+Tuş Jaluzi Anahtarı-Yaylı	12	225,33
2270 407 02XX	Mek+Tuş Light (Çağırma)	12	146,46
2270 407 02XXZ	Mek+Tuş Zil Anahtarı	12	146,46
2270 407 02XXK	Mek+Tuş Kapı Otomatığı Anahtarı	12	146,46
2270 408 02XX	Mek+Tuş Deviatör (Ara Vavien)	12	270,39
2270 409 02XX	Mek+Tuş Uçlu Anahtar	12	261,38
2270 411 02XX	Mek+Tuş Şofben Anahtarı	12	274,90
2270 415 02XX	Mek+Tuş Işıklı Anahtar (220V)	12	229,83
2270 416 02XX	Mek+Tuş Işıklı Vavien (220V)	12	279,41
2270 417 02XX	Mek+Tuş Işıklı Çağırma (220V)	12	292,92
2270 418 02XX	Mek+Tuş Işıklı Etiketli Anahtar (220V)	12	252,37
2270 419 02XX	Mek+Tuş Işıklı Etiketli Çağırma (220V)	12	306,44
2270 422 02XX	Mek+Tuş Işıklı Zil Etiketli Çağırma (12V)	12	369,54
2270 426 02XX	Mek+Tuş Işıklı Komütatör	12	261,38
<b>Anahtar Grubu Klipsli Tip (Kolay Bağlantı)</b>			
2270 401 01XX	Mek+Tuş Anahtar	12	130,69
2270 402 01XX	Mek+Tuş Komütatör	12	166,74
2270 403 01XX	Mek+Tuş Vavien (iki Yollu Anahtar)	12	153,22
2270 404 01XX	Mek+Tuş Komütatör Vavien	12	265,89
2270 405 01XX	Mek+Tuş Çift Kutuplu Anahtar	12	180,26
2270 406 01XX	Mek+Tuş Jaluzi Anahtarı-Yaylı	12	225,33
2270 407 01XX	Mek+Tuş Light (Çağırma)	12	146,46
2270 407 01XXZ	Mek+Tuş Zil Anahtarı	12	146,46
2270 407 01XXK	Mek+Tuş Kapı Otomatığı Anahtarı	12	146,46
2270 408 01XX	Mek+Tuş Deviatör (Ara Vavien)	12	270,39
2270 409 01XX	Mek+Tuş Uçlu Anahtar	12	261,38
2270 415 01XX	Mek+Tuş Işıklı Anahtar (220V)	12	229,83
2270 416 01XX	Mek+Tuş Işıklı Vavien (220V)	12	279,41
2270 417 01XX	Mek+Tuş Işıklı Çağırma (220V)	12	292,92
2270 418 01XX	Mek+Tuş Işıklı Etiketli Anahtar (220V)	12	252,37
2270 419 01XX	Mek+Tuş Işıklı Etiketli Çağırma (220V)	12	306,44
2270 422 01XX	Mek+Tuş Işıklı Zil Etiketli Çağırma (12V)	12	369,54
2270 426 01XX	Mek+Tuş Işıklı Komütatör	12	261,38
<b>Dimmer Grubu</b>			
2270 440 02XX	Mek+Tuş Işıklı Dimmer 600W	8	653,45
2270 444 02XX	Mek+Tuş Işıklı Dimmer 1000W	8	892,29
2270 447 02XX	Mek+Tuş RC Dimmer 325W	8	2.163,14
<b>Elektronik Grubu</b>			
2270 450 01XX	Mek+Tuş Energy Saver Gecikmesiz Işıklı	8	770,62
2270 452 01XX	Mek+Tuş Energy Saver Gecikmeli	8	811,18
2270 470 02XX	Mek+Tuş Müzik Yayın Anahtarı	8	1.135,65
2270 480 01XX	Mek+Tuş Hoparlör Prizi	8	315,46
2270 485 02XX	Mek+Tuş Uyarı Zili	8	1.712,48
2270 495 02XX	Mek+Tuş Hareket Sensörü	8	1.712,48
<b>Priz Grubu</b>			
2270 600 02XX	Mek+Tuş Topraklı Priz	12	166,74
2270 601 02XX	Mek+Tuş Topraksız Priz	12	148,72
2270 605 02XX	Mek+Tuş Topraklı Priz (Ç.K.)	12	234,34
2270 606 02XX	Mek+Tuş Topraksız Priz (Ç.K.)	12	157,73
2270 610 02XX	Mek+Tuş Kapaklı Topraklı Priz	12	184,77
2270 611 02XX	Mek+Tuş Kapaklı Topraklı Priz (Ç.K.)	12	225,33
2270 615 02XX	Mek+Tuş Ups (Fransız) Prizi	12	220,82
2270 616 02XX	Mek+Tuş Ups (Fransız) Prizi (Ç.K.)	12	261,38
2270 617 02XX	Mek+Tuş Ups Kapaklı (Fransız) Priz	12	234,34
2270 618 02XX	Mek+Tuş Ups Kap. (Fransız) Priz (Ç.K.)	12	283,91
2270 121 02XX	Mek+Tuş Kör Kapak	12	126,18
2270 448 01XX	Mek+Tuş Tekli Usb Şarj Prizi	5	563,32
2270 449 01XX	Mek+Tuş İkili Usb Şarj Prizi	5	630,91
<b>İletişim Grubu</b>			
2270 455 01XX	Mek+Tuş Data Prizi 1*Usb	12	360,52
2270 456 01XX	Mek+Tuş Data Prizi 2*Usb	12	630,91
2270 457 01XX	Mek+Tuş Data Prizi 1*Hdmi	12	495,72
2270 458 01XX	Mek+Tuş Data Prizi 2*Hdmi	12	878,77
2270 459 01XX	Mek+Tuş Data Prizi 1*Usb/1*Hdmi	12	1.036,50
2270 125 01XX	Mek+Tuş Telefon Prizi 1*Rj12 Cat3	12	189,27
2270 126 01XX	Mek+Tuş Telefon Prizi 2*Rj12 Cat3	12	279,41
2270 128 01XX	Mek+Tuş Etiketli Tlf+Data Priz (Kon.süz)	12	135,20
2270 135 01XX	Mek+Tuş Data Prizi 1*Rj45 (Kon.süz)	12	121,68
2270 136 01XX	Mek+Tuş Data Prizi 1*Rj45 (Cat5e)	12	401,08
2270 137 01XX	Mek+Tuş Data Prizi 2*Rj45 (Kon.süz)	12	126,18
2270 138 01XX	Mek+Tuş Data Prizi 2*Rj45 (Cat5e)	12	585,85
2270 139 01XX	Mek+Tuş Tlf+Data Priz (Rj12 Cat3+Cat5e)	12	495,72
2270 140 01XX	Mek+Tuş Data Prizi 1*Rj45 (Cat6)	12	401,08
2270 141 01XX	Mek+Tuş Data Prizi 2*Rj45 (Cat6)	12	585,85
2270 147 01XX	Mek+Tuş Bir Çıkışlı Fiber Optik Priz (RJ45)	12	292,92
<b>TV / SAT Grubu</b>			
2270 156 02XX	Mek+Tuş Tv-Sat Prizi (Geçişli) 4DB/F Kon.	12	766,11
2270 157 02XX	Mek+Tuş Tv-Sat Prizi (Sonlu)	12	766,11
2270 166 01XX	Mek+Tuş Sat Prizi (Geçişli) 4DB/F Konnektör	12	675,98
2270 167 01XX	Mek+Tuş Sat Prizi (Sonlu)	12	675,98
2270 170 01XX	Mek+Tuş Tv Prizi (Geçişli) 11DB	12	225,33
2270 171 01XX	Mek+Tuş Tv Prizi (Sonlu)	12	225,33
2270 172 01XX	Mek+Tuş Tv Prizi F Dışı	12	135,20

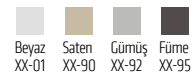
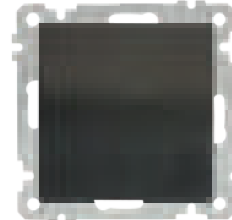
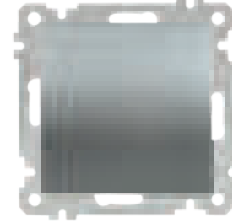
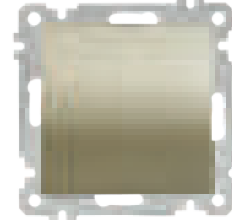
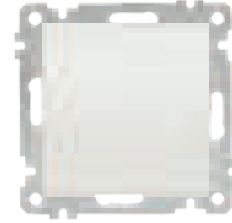
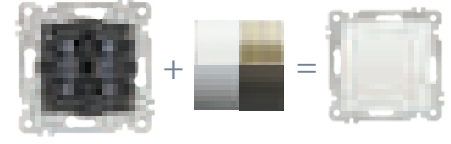

# Candelä

Şık Çözümler için...



VIDALI TİP		KLİPSLİ TİP (KOLAY BAĞLANTI)		DİMMER		PRİZ		ELEKTRONİK	
2125 401 02XX Anahtar	2125 402 02XX Komütatör	2125 403 02XX Vavien (iki Yollu Anahtar)	2125 404 02XX Komütatör Vavien	2125 405 02XX Çift Kutuplu Anahtar	2125 406 02XX Jaluzi Anahtar	2125 407 02XX Çağırma	2125 407 02XXK Kapı Otomatığı Anahtar		
2125 407 02XXZ Zili Anahtar	2125 408 02XX Deviator(Ara Vavien)	2125 409 02XX Uçlu Anahtar	2125 411 02XX Şofben Anahtar	2125 415 02XX Işıklı Anahtar (220V)	2125 416 02XX Işıklı Vavien (220V)	2125 417 02XX Işıklı Çağırma (220V)	2125 418 02XX Işıklı Etik. Anahtar (220V)	2125 419 02XX Işıklı Etik. Çağırma (220V)	
2125 422 02XX Işıklı 7li Flik Çağırma (17V)	2125 426 02XX Işıklı Komütatör	2125 436 02XX Jaluzi Anahtar (Yaysız - Vidalı)		2125 401 01XX Anahtar	2125 402 01XX Komütatör	2125 403 01XX Vavien (iki Yollu Anahtar)	2125 404 01XX Komütatör Vavien	2125 405 01XX Çift Kutuplu Anahtar	
2125 406 01XX Jaluzi Anahtar	2125 407 01XX Çağırma	2125 407 01XXK Kapı Otomatığı Anahtar	2125 407 01XXZ Zili Anahtar	2125 408 01XX Deviator(Ara Vavien)	2125 409 01XX Uçlu Anahtar	2125 415 01XX Işıklı Anahtar (220V)	2125 416 01XX Işıklı Vavien (220V)	2125 417 01XX Işıklı Çağırma (220V)	
2125 418 01XX Işıklı Etik. Anahtar (220V)	2125 419 01XX Işıklı Etik. Çağırma (220V)	2125 422 01XX Işıklı Zili Etik. Çağırma (12V)	2125 426 01XX Işıklı Komütatör		2125 440 02XX RL Işıklı Dimmer 600W	2125 444 02XX RL Işıklı Dimmer 1000W	2125 447 02XX RC Dimmer 325W		
2125 450 01XX Energy Saver G.siz Işıklı	2125 452 01XX Energy Saver Gecikmeli Işıklı	2125 470 02XX Müzik Yayın Anahtar	2125 480 01XX Hoparfor Prizi	2125 485 02XX Uyanı Zili	2125 495 02XX Hareket Sensörü		2125 600 02XX Topraklı Priz	2125 601 02XX Topraksız Priz	
2125 605 02XX Topraklı Priz (Ç.K.)	2125 606 02XX Topraksız Priz (Ç.K.)	2125 610 02XX Kapaklı Topraklı Priz	2125 611 02XX Kapaklı Topraklı Priz (Ç.K.)	2125 615 02XX Ups (Fransız) Prizi	2125 616 02XX Ups (Fransız) Prizi (Ç.K.)	2125 617 02XX Ups Kapaklı (Fransız) Priz	2125 618 02XX Ups Kapaklı (Fr.) Priz (Ç.K.)	2125 448 01XX Tekli Usb Şarj Prizi	
2125 449 01XX İkili Usb Şarj Prizi	2125 200 02XX İkili Topraklı Priz Porselen	2125 201 02XX İkili Topraksız Priz Porselen	2125 202 02XX İkili Topraklı Priz	2125 203 02XX İkili Topraksız Priz	2125 215 01XX İkili Ups Priz				
İLETİŞİM		2125 125 01XX Telefon Prizi 1Xr12 (Cat3)	2125 126 01XX Telefon Prizi 2Xr12 (Cat3)	2125 128 01XX Etiketli Tlf Data Priz (Kon.süz)	2125 135 02XX Data Prizi 1*Rj45 (Kon.süz)	2125 136 01XX Data Prizi 1*Rj45 (Cat5e)	2125 137 01XX Data Prizi 2*Rj45 (Kon.süz)	2125 138 01XX Data Prizi 2*Rj45 (Cat5e)	2125 139 01XX Tlf Data Priz (Rj12 Cat3 + Cat5e)
2125 140 01XX Data Prizi 1*Rj45 (Cat6)	2125 141 01XX Data Prizi 2*Rj45 (Cat6)	2125 455 01XX Data Prizi 1*Usb	2125 456 01XX Data Prizi 2*Usb	2125 457 01XX Data Prizi 1*Hdmi	2125 458 01XX Data Prizi 2*Hdmi	2125 459 01XX Data Prizi 1*Usb/1*Hdmi	2125 460 01XX VGA Priz	2125 121 02XX Kor Kapak	
TV / SAT		2125 156 02XX Tv-Sat Prizi (Geçişli) 4DB/F Kon.	2125 157 02XX Tv-Sat Prizi (Sönü)	2125 166 01XX Sat Prizi (Geçişli) 4DB/F Kon.	2125 167 01XX Sat Prizi (Sönü)	2125 170 01XX Tv Prizi (Geçişli) 11DB	2125 171 01XX Tv Prizi (Sönü)	2125 172 01XX Tv Priz F Dişi	

NATURAL



01 -BEYAZ



02 -KREM

AHŞAP



56 -KIRAZ

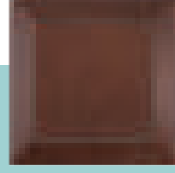

57 -CEVİZ

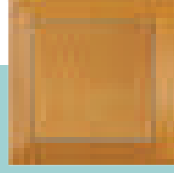

58 -MEŞE

METALİK



80 -A.ALTIN



82 -İNOX



83 -TİTANYUM

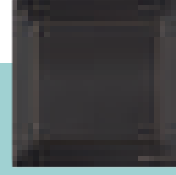

84 -SİYAH



85 -DORE



95 -FÜME



# Candela

## Mekanizma + Tuş Ürün Listesi

Kod	Ürün Tanımı	Kutu Adedi	Koli Adedi	Beyaz/Krem Fiyat (₺)	Metalik Fiyat (₺)	Ahşap Fiyat (₺)
-----	-------------	------------	------------	----------------------	-------------------	-----------------

### Anahtar Grubu Vidalı Tip

2100 401 02XX	Mek+Tuş Anahtar (Vidalı)	12	120	100,50	130,69	143,76
2100 402 02XX	Mek+Tuş Komütatör (Vidalı)	12	120	132,94	166,74	183,42
2100 403 02XX	Mek+Tuş Vavien (İki Yollu Anahtar)(Vidalı)	12	120	130,69	153,22	168,54
2100 404 02XX	Mek+Tuş Komütatör Vavien (Vidalı)	12	120	226,35	265,89	292,47
2100 405 02XX	Mek+Tuş Çift Kutuplu Anahtar (Vidalı)	12	120	148,74	180,26	198,29
2100 406 02XX	Mek+Tuş Jaluzi Anahtar (Vidalı)	12	120	191,18	225,33	247,86
2100 407 02XX	Mek+Tuş Çağırma (Vidalı)	12	120	105,00	146,46	161,11
2100 407 02XXK	Mek+Tuş Kapı Otomatığı Anahtar (Vidalı)	12	120	105,00	146,46	161,11
2100 407 02XXZ	Mek+Tuş Zil Anahtar (Vidalı)	12	120	105,00	146,46	161,11
2100 408 02XX	Mek+Tuş Deviyatör(Ara Vavien)(Vidalı)	12	120	209,06	270,39	297,43
2100 409 02XX	Mek+Tuş Üçlü Anahtar (Vidalı)	12	120	207,30	261,38	287,52
2100 411 02XX	Mek+Tuş Şofben Anahtar (Vidalı)	12	120	202,19	274,90	302,39
2100 415 02XX	Mek+Tuş Işıklı Anahtar (220V) (Vidalı)	12	120	191,14	229,83	252,82
2100 416 02XX	Mek+Tuş Işıklı Anahtar (220V) (Vidalı)	12	120	244,21	279,41	307,35
2100 417 02XX	Mek+Tuş Işıklı Çağırma (220V)(Vidalı)	12	120	200,86	292,92	322,22
2100 418 02XX	Mek+Tuş Işıklı Etik. Anahtar (220V)(Vidalı)	12	120	220,22	252,37	277,60
2100 419 02XX	Mek+Tuş Işıklı Etik. Çağırma (220V)(Vidalı)	12	120	214,18	306,44	337,09
2100 422 02XX	Mek+Tuş Işıklı Zil Etik. Çağırma (12V)(Vidalı)	12	120	280,56	369,54	406,49
2100 426 02XX	Mek+Tuş Işıklı Komütatör (Vidalı)	12	120	250,04	261,38	282,56
2100 436 02XX	Mek+Tuş Jaluzi Anahtar (Yaysız)(Vidalı)	12	120	205,25	292,92	322,22

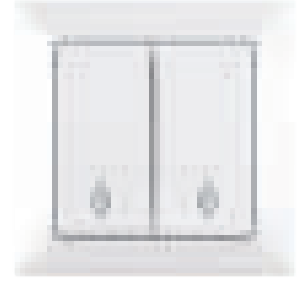

### Anahtar Grubu Klipsli Tip (Kolay Bağlantı)

2100 401 01XX	Mek+Tuş Anahtar (Klipsli)	12	120	100,50	130,69	143,76
2100 402 01XX	Mek+Tuş Komütatör (Klipsli)	12	120	132,94	166,74	183,42
2100 403 01XX	Mek+Tuş Vavien (İki Yollu Anahtar)(Klipsli)	12	120	130,69	153,22	168,54
2100 404 01XX	Mek+Tuş Komütatör Vavien (Klipsli)	12	120	226,35	265,89	292,47
2100 405 01XX	Mek+Tuş Çift Kutuplu Anahtar (Klipsli)	12	120	148,74	180,26	198,29
2100 406 01XX	Mek+Tuş Jaluzi Anahtar (Klipsli)	12	120	191,18	225,33	247,86
2100 407 01XX	Mek+Tuş Çağırma (Klipsli)	12	120	105,00	146,46	161,11
2100 407 01XXK	Mek+Tuş Kapı Otomatığı Anahtar (Klipsli)	12	120	105,00	146,46	161,11
2100 407 01XXZ	Mek+Tuş Zil Anahtar (Klipsli)	12	120	105,00	146,46	161,11
2100 408 01XX	Mek+Tuş Deviyatör(Ara Vavien)(Klipsli)	12	120	209,06	270,39	297,43
2100 409 01XX	Mek+Tuş Üçlü Anahtar (Klipsli)	12	120	207,30	261,38	287,52
2100 415 01XX	Mek+Tuş Işıklı Anahtar (220V) (Klipsli)	12	120	191,14	229,83	252,82
2100 416 01XX	Mek+Tuş Işıklı Vavien (220V) (Klipsli)	12	120	244,21	279,41	307,35
2100 417 01XX	Mek+Tuş Işıklı Çağırma (220V)(Klipsli)	12	120	200,86	292,92	322,22
2100 418 01XX	Mek+Tuş Işıklı Etik. Anahtar (220V)(Klipsli)	12	120	220,22	252,37	277,60
2100 419 01XX	Mek+Tuş Işıklı Etik. Çağırma (220V)(Klipsli)	12	120	214,18	306,44	337,09
2100 422 01XX	Mek+Tuş Işıklı Zil Etik. Çağırma (12V)(Klipsli)	12	120	280,56	369,54	406,49
2100 426 01XX	Mek+Tuş Işıklı Komütatör (Vidalı)	12	120	250,04	261,38	282,56
2100 436 01XX	Mek+Tuş Jaluzi Anahtar (Yaysız)(Klipsli)	12	120	205,25	292,92	322,22

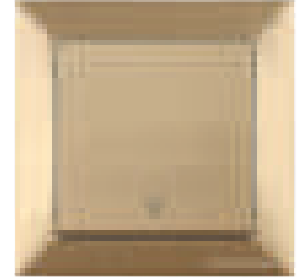

### Dimmer Grubu

2100 440 02XX	Mek+Tuş RL Işıklı Dimmer 600W	8	80	585,85	653,45	849,48
2100 444 02XX	Mek+Tuş RL Işıklı Dimmer 1000W	8	80	630,91	892,29	1.009,46
2100 447 02XX	Mek+Tuş RC Dimmer 325W	8	80	1.351,96	2.163,14	2.379,45



### Elektronik Grubu

2100 450 01XX	Mek+Tuş Energy Saver G.siz Işıklı	8	80	721,05	770,62	886,21
2100 452 01XX	Mek+Tuş Energy Saver Gecikmeli Işıklı	8	80	721,05	811,18	932,85
2100 470 02XX	Mek+Tuş Müzik Yayın Anahtar	8	80	1.081,57	1.135,65	1.305,99
2100 480 01XX	Mek+Tuş Hoparlör Prizi	8	80	225,33	315,46	362,78
2100 485 02XX	Mek+Tuş Uyarı Zili	8	80	1.577,29	1.712,48	1.969,36
2100 495 02XX	Mek+Tuş Hareket Sensörü	8	80	1.577,29	1.712,48	1.969,36

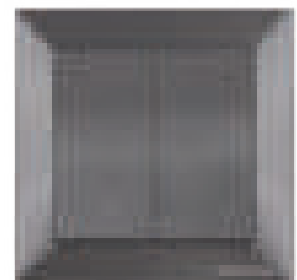

### Priz Grubu

2100 600 02XX	Mek+Tuş Topraklı Priz	12	120	127,53	166,74	191,75
2100 601 02XX	Mek+Tuş Topraksız Priz	12	120	110,41	148,72	171,02
2100 605 02XX	Mek+Tuş Topraklı Priz (Ç.K.)	12	120	162,24	202,79	233,21
2100 606 02XX	Mek+Tuş Topraksız Priz (Ç.K.)	12	120	144,21	157,73	181,39
2100 610 02XX	Mek+Tuş Kapaklı Topraklı Priz	12	120	153,22	184,77	212,48
2100 611 02XX	Mek+Tuş Kapaklı Topraklı Priz (Ç.K.)	12	120	171,25	225,33	259,13
2100 615 02XX	Mek+Tuş Ups (Fransız) Prizi	12	120	180,26	220,82	253,94
2100 616 02XX	Mek+Tuş Ups (Fransız) Prizi (Ç.K.)	12	120	191,53	261,38	300,59
2100 617 02XX	Mek+Tuş Ups Kapaklı (Fransız) Priz	12	120	175,75	234,34	269,49
2100 618 02XX	Mek+Tuş Ups Kapaklı (Fr.) Priz (Ç.K.)	12	120	193,33	283,91	326,50
2100 200 02XX	Mek+Tuş İkili Topraklı Priz Porselen	5	50	290,03	405,59	466,43
2100 201 02XX	Mek+Tuş İkili Topraksız Priz Porselen	5	50	247,01	301,94	347,23
2100 202 02XX	Mek+Tuş İkili Topraklı Priz	5	50	247,86	270,39	310,95
2100 203 02XX	Mek+Tuş İkili Topraksız Priz	5	50	229,19	247,86	285,04
2100 215 01XX	Mek+Tuş İkili Ups Priz	5	50	243,53	292,92	336,86
2100 448 01XX	Mek+Tuş Tekli Usb Şarj Prizi	5	50	473,19	563,32	647,81
2100 449 01XX	Mek+Tuş İkili Usb Şarj Prizi	5	50	576,84	630,91	769,72
2100 469 01XX	Mek+Tuş İkili Usb + Type-C Şarj Prizi	5	50	634,52	675,07	820,05

Kod	Ürün Tanımı	Kutu Adedi	Koli Adedi	Beyaz/Krem Fiyat (₺)	Metalik Fiyat (₺)	Ahşap Fiyat (₺)
-----	-------------	------------	------------	----------------------	-------------------	-----------------

### İletişim Grubu

2100 125 01XX	Mek+Tuş Telefon Prizi 1Xrj12 (Cat3)	12	120	135,20	189,27	246,06
2100 126 01XX	Mek+Tuş Telefon Prizi 2Xrj12 (Cat3)	12	120	225,33	279,41	363,23
2100 128 01XX	Mek+Tuş Etiketli Tlf Data Priz (Kon.süz)	12	120	121,68	135,20	175,75
2100 135 01XX	Mek+Tuş Data Prizi 1*Rj45 (Kon.süz)	12	120	108,16	121,68	160,61
2100 136 01XX	Mek+Tuş Data Prizi 1*Rj45 (Cat5e)	12	120	383,06	401,08	521,41
2100 137 01XX	Mek+Tuş Data Prizi 2*Rj45 (Kon.süz)	12	120	112,66	126,18	164,04
2100 138 01XX	Mek+Tuş Data Prizi 2*Rj45 (Cat5e)	12	120	540,78	585,85	761,60
2100 139 01XX	Mek+Tuş Tlf Data Priz (Rj12 Cat3 + Cat5e)	12	120	473,19	495,72	644,43
2100 140 01XX	Mek+Tuş Data Prizi 1*Rj45 (Cat6)	12	120	383,06	401,08	521,41
2100 141 01XX	Mek+Tuş Data Prizi 2*Rj45 (Cat6)	12	120	540,78	585,85	761,60
2100 455 01XX	Mek+Tuş Data Prizi 1*Usb	12	120	337,99	360,52	468,68
2100 456 01XX	Mek+Tuş Data Prizi 2*Usb	12	120	567,82	630,91	820,19
2100 457 01XX	Mek+Tuş Data Prizi 1*Hdmı	12	120	441,64	495,72	644,43
2100 458 01XX	Mek+Tuş Data Prizi 2*Hdmı	12	120	793,15	878,77	1.142,41
2100 459 01XX	Mek+Tuş Data Prizi 1*Usb/1*Hdmı	12	120	901,31	1.036,50	1.347,45
2100 460 01XX	Mek+Tuş VGA Priz	12	120	901,31	1.036,50	1.347,45
2100 121 02XX	Mek+Tuş Kör Kapak	12	120	78,86	126,18	164,04

### TV / SAT Grubu

2100 156 02XX	Mek+Tuş Tv-Sat Prizi (Geçişli) 4DB/F Kon.	12	120	721,05	766,11	842,72
2100 157 02XX	Mek+Tuş Tv-Sat Prizi (Sonlu)	12	120	721,05	766,11	842,72
2100 166 01XX	Mek+Tuş Sat Prizi (Geçişli) 4DB/F Kon.	12	120	630,91	675,98	743,58
2100 167 01XX	Mek+Tuş Sat Prizi (Sonlu)	12	120	630,91	675,98	743,58
2100 170 01XX	Mek+Tuş Tv Prizi (Geçişli) 11DB	12	120	202,79	225,33	270,39
2100 171 01XX	Mek+Tuş Tv Prizi (Sonlu)	12	120	202,79	225,33	270,39
2100 172 01XX	Mek+Tuş Tv Prizi F Dişi	12	120	112,66	135,20	148,72

### Çerçeveler

2125 800 11XX	Tekli Çerçeve	20	400	13,52	56,33	61,96
2125 800 12XX	İkili Yatay Çerçeve	10	200	72,10	114,92	126,41
2125 800 13XX	Üçlü Yatay Çerçeve	10	50	101,40	162,24	178,46
2125 800 14XX	Dörtlü Yatay Çerçeve	10	50	130,69	202,79	223,07
2125 800 15XX	Beşli Yatay Çerçeve	10	50	166,74	247,86	272,65
2125 800 16XX	Altılı Yatay Çerçeve	10	50	193,78	292,92	322,22
2125 800 22XX	İkili Dikey Çerçeve	10	50	72,10	90,13	99,14
2125 800 23XX	Üçlü Dikey Çerçeve	10	50	101,40	114,92	143,65
2125 800 24XX	Dörtlü Dikey Çerçeve	10	50	130,69	162,24	178,46
2125 800 25XX	Beşli Dikey Çerçeve	10	50	166,74	225,33	247,86
2125 800 26XX	Altılı Dikey Çerçeve	10	50	193,78	247,86	272,65
2125 820 12XX	İkili Priz Çerçeve	12	60	45,07	90,13	99,14
2100 000 11XX	Sıva Üstü Kasa	12	60	67,60	112,66	129,56
2200 000 0001	IP44 Kapaklı Priz Conta (Resmi Sayfa 30'da)	24	120	33,80	-	-

### İngiliz Tip

2190 500 0201	İngiliz Tipi Anahtarlı Priz Beyaz	12	120	339,82	-	-
---------------	-----------------------------------	----	-----	--------	---	---

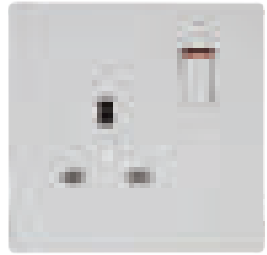
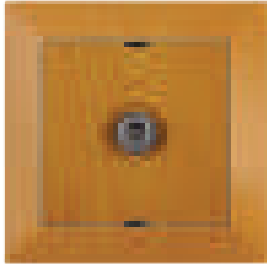
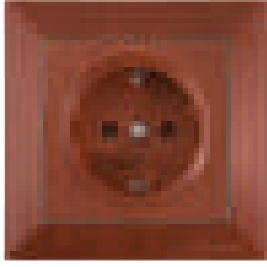

**RİTA MODÜLER SİSTEM**

Kod	Ürün Tanımı	Kutu Adedi	Fiyat
2200 250 01XX	Mek+Tuş Speakhone Prizi	1	MÜŞTERİ TEMSİLCİSİNE FİYAT SORUNUZ
2200 251 01XX	Mek+Tuş RCA Prizi	1	
2200 252 01XX	Mek+Tuş 3,5 Ses Jaki	1	
2200 253 01XX	Mek+Tuş XLR Erkek Prizi	1	
2200 254 01XX	Mek+Tuş XLR Dişi Prizi	1	
2200 255 01XX	Mek+Tuş Usb Printer Prizi	1	

**ENERGY SAVER ÜRÜN LİSTESİ**

Kod	Ürün Tanımı	Kutu Adedi	Fiyat
2110 052 0001	Energy Saver Kapak	1	MÜŞTERİ TEMSİLCİSİNE FİYAT SORUNUZ
2100 012 01XX	Mek+Tuş Impuls Anahtar	12	
2100 023 01XX	Mek+Tuş Impuls Komütatör	12	
2100 024 01XX	Mek+Tuş Impuls Işıklı Anahtar (220V)	12	
2100 027 01XX	Mek+Tuş Impuls Işıklı Komütatör	12	
2125 010 0101	Otel Uyarı İç Ünitesi Komütatörü (Mekanik) Işıklı	12	
2220 010 0101	Rita Otel Uyarı İç Ünitesi Komütatörü (Mekanik) Işıklı	12	
2220 010 0201	Rita Otel Uyarı İç Ünitesi Komütatörü (Mekanik) Işıklı Vidalı	12	
2200 412 01XX	Rita Mek Tuş Impuls Anahtar (Klipsli)	12	
2200 412 02XX	Rita Mek Tuş Impuls Anahtar (Vidalı)	12	
2200 423 01XX	Rita Mek Tuş Impuls Komütatör (Klipsli)	12	
2200 423 02XX	Rita Mek Tuş Impuls Komütatör (Vidalı)	12	
2200 424 01XX	Rita Mek Tuş Impuls Işıklı Anahtar(Klipsli)	12	
2200 424 02XX	Rita Mek Tuş Impuls Işıklı Anahtar (Vidalı)	12	
2200 427 01XX	Rita Mek Tuş Impuls Işıklı Komütatör (Klipsli)	12	
2200 427 02XX	Rita Mek Tuş Impuls Işıklı Komütatör (Vidalı)	12	

# BELLA



Uzun ömürlü, nemli mekanlarda güvenli kullanım...



# BELLA Serisi

## Beyaz / Gri Ürün Listesi

Kod	Ürün Tanımı	Kutu Adedi	Koli Adedi	Fiyat (₺)
<b>Anahtar Grubu</b>				
2151 001 02XX	Anahtar	8	80	140,91
2151 002 02XX	Komütatör	8	80	181,82
2151 003 02XX	Vavien (İki Yollu Anahtar)	8	80	159,09
2151 005 02XX	Çift Kutuplu Anahtar	8	80	181,82
2151 006 02XX	Jaluzi Anahtarı	8	80	218,18
2151 007 02XXX	Kapı Otomatığı Anahtarı	8	80	159,09
2151 007 02XXZ	Zil Anahtarı	8	80	159,09
2151 007 02XX	Çağırma Anahtarı	8	80	159,09
2151 008 02XX	Deviatör (Ara Vavien)	8	80	227,27
<b>Priz Grubu</b>				
2151 180 02XX	Kapaklı Topraklı Priz	8	80	154,55
2151 210 02XX	Kapaklı Topraklı İkili Priz	8	80	295,45
2151 220 02XX	Kapaklı Topraklı İkili Dikey Priz	8	80	295,45
2151 511 02XX	İkili Anahtar + Topraklı Priz	4	40	295,45
2151 521 02XX	İkili Komitatör + Topraklı Priz	4	40	340,91
<b>TV / SAT Grubu</b>				
2151 166 02XX	Sat Prizi (Geçişli)	8	80	363,64
2151 167 02XX	Sat Prizi (Sonlu)	8	80	363,64
2151 170 02XX	TV Prizi (Geçişli)	8	80	227,27
2151 171 02XX	TV Prizi (Sonlu)	8	80	227,27
<b>Buat Grubu</b>				
2151 000 01XX	6 Çıkış Buat	8	80	113,64



# BELLA Serisi

## Ahşap Ürün Listesi

Kod	Ürün Tanımı	Kutu Adedi	Koli Adedi	Fiyat (₺)
<b>Anahtar Grubu</b>				
2151 001 02XX	Anahtar Ahşap	8	80	186,36
2151 002 02XX	Komütatör Ahşap	8	80	227,27
2151 003 02XX	Vavien (İki Yollu Anahtar) Ahşap	8	80	204,55
2151 005 02XX	Çift Kutuplu Anahtar Ahşap	8	80	227,27
2151 006 02XX	Jaluzi Anahtarı Ahşap	8	80	272,73
2151 007 02XX	Çağırma Anahtarı Ahşap	8	80	204,55
2151 007 02XXX	Kapı Otomatığı Anahtarı Ahşap	8	80	204,55
2151 007 02XXZ	Zil Anahtarı Ahşap	8	80	204,55
2151 008 02XX	Deviatör (Ara Vavien)	8	80	272,73
<b>Priz Grubu</b>				
2151 180 02XX	Kapaklı Topraklı Priz	8	80	204,55
2151 210 02XX	Kapaklı Topraklı İkili Priz	8	80	363,64
2151 220 02XX	Kapaklı Topraklı İkili Dikey Priz	8	80	363,64
2151 511 02XX	İkili Anahtar + Topraklı Priz	4	40	363,64
2151 521 02XX	İkili Komitatör + Topraklı Priz	4	40	409,09
<b>TV / SAT Grubu</b>				
2151 166 02XX	Sat Prizi (Geçişli)	8	80	409,09
2151 167 02XX	Sat Prizi (Sonlu)	8	80	409,09
2151 170 02XX	TV Prizi (Geçişli)	8	80	272,73
2151 171 02XX	TV Prizi (Sonlu)	8	80	272,73
<b>Buat Grubu</b>				
2151 000 01XX	6 Çıkış Buat	8	80	159,09

# NORA



Riskleri minimize eden, şık ve kullanışlı tasarım.



# NORA Serisi

Beyaz / Gri Ürün Listesi

Kod	Ürün Tanımı	Kutu Adedi	Koli Adedi	Fiyat (₺)
<b>Anahtar Grubu</b>				
2155 001 02XX	Anahtar	8	80	154,55
2155 002 02XX	Komütatör	8	80	200,00
2155 003 02XX	Vavien (İki Yollu Anahtar)	8	80	177,27
2155 004 02XX	Komütatör Vavien	8	80	219,96
2155 005 02XX	Çift Kutuplu Anahtar	8	80	200,00
2155 007 02XX	Çağırma Anahtarı	8	80	177,27
2155 007 02XXZ	Zil Anahtarı	8	80	177,27
2155 008 02XX	Deviatör (Ara Vavien)	8	80	245,45
2155 025 02XX	Jaluzi Anahtarı	8	80	236,36
2155 037 02XX	Acil Çağırma (İpli)	8	80	272,73

## Priz Grubu

2155 180 02XX	Kapaklı Topraklı Priz	8	80	168,18
2155 187 02XX	Kapaklı Topraklı UPS Priz	8	80	168,18
2155 188 02XX	Kapaklı Topraklı UPS Priz (Çocuk Korumalı)	8	80	181,82
2155 210 02XX	Kapaklı Topraklı İkili Priz	4	40	309,09
2155 217 02XX	Kapaklı Topraklı İkili UPS Priz	4	40	309,09
2155 220 02XX	Kapaklı Topraklı İkili Dikey Priz	4	40	309,09
2155 227 02XX	Kapaklı Topraklı İkili Dikey UPS Priz	4	40	309,09
2155 511 02XX	İkili Anahtar + Topraklı Priz	4	40	313,64
2155 521 02XX	İkili Komitatör + Topraklı Priz	4	40	359,09

## TV / SAT Grubu

2155 166 02XX	Sat Prizi (Geçişli)	8	80	386,36
2155 167 02XX	Sat Prizi (Sonlu)	8	80	386,36
2155 170 02XX	TV Prizi (Geçişli)	8	80	272,73
2155 171 02XX	TV Prizi (Sonlu)	8	80	272,73

## Buat Grubu

2155 000 01XX	4 Çıkış Buat	8	80	136,36
---------------	--------------	---	----	--------

■ Beyaz 01

■ Gri 03



# BRON

Sıva üstü uygulamalarda  
sorunsuz işlevsel çözümler...



## BRON Natural

### Sıva Üstü Anahtar Priz Serisi

#### Beyaz / Krem Ürün Listesi

Kod	Ürün Tanımı	Kutu Adedi	Koli Adedi	Fiyat (₺)
2160 301 02XX	Bron S/Ü Anahtar	12	120	144,21
2160 302 02XX	Bron S/Ü Komütatör	12	120	180,26
2160 303 02XX	Bron S/Ü Vavien	12	120	180,26
2160 307 02XX	Bron S/Ü Light (Çağırma)	12	120	157,73
2160 315 02XX	Bron S/Ü Işıklı Anahtar (220V)	12	120	198,29
2160 316 02XX	Bron S/Ü Işıklı Vavien (220V)	12	120	225,33
2160 317 02XX	Bron S/Ü Işıklı Light (Çağırma) (220V)	12	120	202,79
2160 326 02XX	Bron S/Ü Işıklı Komütatör	12	120	225,33
2160 100 02XX	Bron S/Ü Topraklı Priz	12	120	180,26
2160 101 02XX	Bron S/Ü Topraksız Priz	12	120	157,73
2160 103 02XX	Bron S/Ü Topraklı Priz Porselen	12	120	225,33
2160 104 02XX	Bron S/Ü Topraksız Priz Porselen	12	120	202,79
2160 110 02XX	Bron S/Ü Kapaklı Topraklı Priz	10	100	202,79
2160 113 02XX	Bron S/Ü Kapaklı Topraklı Priz Porselen	10	100	247,86
2160 115 02XX	Bron S/Ü Ups (Fransız) Priz	12	120	202,79
2160 125 02XX	Bron S/Ü Telefon Prizi 1*Rj12 Cat3	12	120	157,73
2160 136 02XX	Bron S/Ü Data Prizi 1*Rj45 (Cat5)	12	120	180,26
2160 140 02XX	Bron S/Ü Data Prizi 1*Rj45 (Cat6)	12	120	180,26
2160 166 02XX	Bron S/Ü Sat Prizi (Geçişli) 4Db/F Konnektör	12	120	315,46
2160 167 02XX	Bron S/Ü Sat Prizi (Sonlu)	12	120	315,46
2160 170 02XX	Bron S/Ü Tv Prizi (Geçişli)	12	120	315,46
2160 171 02XX	Bron S/Ü Tv Prizi (Sonlu)	12	120	315,46
2160 200 02XX	Bron S/Ü İkili Topraklı Priz Porselen	6	60	270,39
2160 201 02XX	Bron İkili Topraksız Priz Porselen	6	60	247,86
2160 202 02XX	Bron S/Ü İkili Topraklı Priz	6	60	247,86
2160 203 02XX	Bron S/Ü İkili Topraksız Priz	6	60	225,33
2160 215 02XX	Bron S/Ü İkili Ups (Fransız) Priz	6	60	247,86



Beyaz 01  
Krem 02

ANAHTAR PRİZ GRUBU

## BRON Ahşap

### Sıva Üstü Anahtar Priz Serisi

#### Meşe / Ceviz Ürün Listesi

Kod	Ürün Tanımı	Kutu Adedi	Koli Adedi	Fiyat (₺)
2160 301 02XX	Bron S/Ü Anahtar	12	120	202,79
2160 302 02XX	Bron S/Ü Komütatör	12	120	247,86
2160 303 02XX	Bron S/Ü Vavien	12	120	247,86
2160 307 02XX	Bron S/Ü Light (Çağırma)	12	120	225,33
2160 315 02XX	Bron S/Ü Işıklı Anahtar (220V)	12	120	270,39
2160 316 02XX	Bron S/Ü Işıklı Vavien (220V)	12	120	292,92
2160 317 02XX	Bron S/Ü Işıklı Light (Çağırma) (220V)	12	120	270,39
2160 326 02XX	Bron S/Ü Işıklı Komütatör	12	120	292,92
2160 100 02XX	Bron S/Ü Topraklı Priz	12	120	247,86
2160 101 02XX	Bron S/Ü Topraksız Priz	12	120	225,33
2160 103 02XX	Bron S/Ü Topraklı Priz Porselen	12	120	270,39
2160 104 02XX	Bron S/Ü Topraksız Priz Porselen	12	120	247,86
2160 110 02XX	Bron S/Ü Kapaklı Topraklı Priz	10	100	270,39
2160 113 02XX	Bron S/Ü Kapaklı Topraklı Priz Porselen	10	100	315,46
2160 115 02XX	Bron S/Ü Ups (Fransız) Priz	12	120	270,39
2160 125 02XX	Bron S/Ü Telefon Prizi 1*Rj12 Cat3	12	120	225,33
2160 136 02XX	Bron S/Ü Data Prizi 1*Rj45 (Cat5)	12	120	247,86
2160 140 02XX	Bron S/Ü Data Prizi 1*Rj45 (Cat6)	12	120	247,86
2160 166 02XX	Bron S/Ü Sat Prizi (Geçişli) 4Db/F Konnektör	12	120	360,52
2160 167 02XX	Bron S/Ü Sat Prizi (Sonlu)	12	120	360,52
2160 170 02XX	Bron S/Ü Tv Prizi (Geçişli)	12	120	360,52
2160 171 02XX	Bron S/Ü Tv Prizi (Sonlu)	12	120	360,52
2160 200 02XX	Bron S/Ü İkili Topraklı Priz Porselen	6	60	315,46
2160 201 02XX	Bron İkili Topraksız Priz Porselen	6	60	270,39
2160 202 02XX	Bron S/Ü İkili Topraklı Priz	6	60	315,46
2160 203 02XX	Bron S/Ü İkili Topraksız Priz	6	60	292,92
2160 215 02XX	Bron S/Ü İkili Ups (Fransız) Priz	6	60	360,52

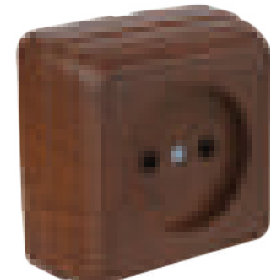
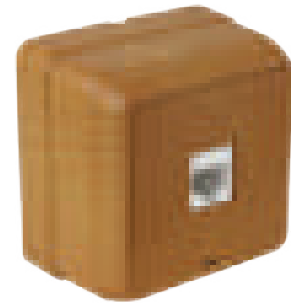

Meşe 58  
Ceviz 57

# Fiş Prizler Grup Prizler



Taşınabilir enerji ihtiyacınız için en kullanışlı seçenekler...



## Ri-tech Grup Prizler

Kod	Ürün Tanımı	Kutu Adedi	Fiyat (₺)
001 175 210001 00 00	İKİLİ TOPLI GRUP PRİZ(Ç.K.)(KLEMENSLİ)	25	204,55
001 175 210002 01 00	İKİLİ TOPLI GRUP PRİZ(Ç.K.)(1 MT)	12	340,91
001 175 210002 02 00	İKİLİ TOPLI GRUP PRİZ(Ç.K.)(2 MT)	12	454,55
001 175 210002 03 00	İKİLİ TOPLI GRUP PRİZ(Ç.K.)(3 MT)	12	545,45
001 175 210002 05 00	İKİLİ TOPLI GRUP PRİZ(Ç.K.)(5 MT)	12	681,82
001 175 220001 00 00	İKİLİ ANAHT. TOPLI GRUP PRİZ(Ç.K.)(KLEMENSLİ)	25	363,64
001 175 220002 01 00	İKİLİ ANAHT. TOPLI GRUP PRİZ(Ç.K.)(1 MT)	12	500,00
001 175 220002 02 00	İKİLİ ANAHT. TOPLI GRUP PRİZ(Ç.K.)(2 MT)	12	613,64
001 175 220002 03 00	İKİLİ ANAHT. TOPLI GRUP PRİZ(Ç.K.)(3 MT)	12	704,55
001 175 220002 05 00	İKİLİ ANAHT. TOPLI GRUP PRİZ(Ç.K.)(5 MT)	12	840,91
001 175 310001 00 00	ÜÇLÜ TOPLI GRUP PRİZ(Ç.K.)(KLEMENSLİ)	25	227,27
001 175 310002 01 00	ÜÇLÜ TOPLI GRUP PRİZ(Ç.K.)(1 MT)	12	386,36
001 175 310002 02 00	ÜÇLÜ TOPLI GRUP PRİZ(Ç.K.)(2 MT)	12	500,00
001 175 310002 03 00	ÜÇLÜ TOPLI GRUP PRİZ(Ç.K.)(3 MT)	12	590,91
001 175 310002 05 00	ÜÇLÜ TOPLI GRUP PRİZ(Ç.K.)(5 MT)	12	727,27
001 175 320001 00 00	ÜÇLÜ ANAHT. TOPLI GRUP PRİZ(Ç.K.)(KLEMENSLİ)	25	409,09
001 175 320002 01 00	ÜÇLÜ ANAHT. TOPLI GRUP PRİZ(Ç.K.)(1 MT)	12	568,18
001 175 320002 02 00	ÜÇLÜ ANAHT. TOPLI GRUP PRİZ(Ç.K.)(2 MT)	12	681,82
001 175 320002 03 00	ÜÇLÜ ANAHT. TOPLI GRUP PRİZ(Ç.K.)(3 MT)	12	772,73
001 175 320002 05 00	ÜÇLÜ ANAHT. TOPLI GRUP PRİZ(Ç.K.)(5 MT)	12	909,09
001 175 350001 00 00	ÜÇLÜ USB ANAHT. TOPLI GRUP PRİZ(Ç.K.)(KLEMENSLİ)	25	909,09
001 175 350002 02 00	ÜÇLÜ USB ANAHT. TOPLI GRUP PRİZ(Ç.K.)(2 MT)	12	1.227,27
001 175 350002 03 00	ÜÇLÜ USB ANAHT. TOPLI GRUP PRİZ(Ç.K.)(3 MT)	12	1.363,64
001 175 350002 05 00	ÜÇLÜ USB ANAHT. TOPLI GRUP PRİZ(Ç.K.)(5 MT)	12	1.545,45
<b>YENİ</b> 001 175 350101 00 00	ÜÇLÜ USB + TYPE-C ANAHT. TOPLI GRUP PRİZ(Ç.K.)(KLEMENSLİ)	25	1.000,00
<b>YENİ</b> 001 175 350102 02 00	ÜÇLÜ USB + TYPE-C ANAHT. TOPLI GRUP PRİZ(Ç.K.)(2 MT)	12	1.350,00
<b>YENİ</b> 001 175 350102 03 00	ÜÇLÜ USB + TYPE-C ANAHT. TOPLI GRUP PRİZ(Ç.K.)(3 MT)	12	1.500,00
<b>YENİ</b> 001 175 350102 05 00	ÜÇLÜ USB + TYPE-C ANAHT. TOPLI GRUP PRİZ(Ç.K.)(5 MT)	12	1.700,00
001 175 410001 00 00	DÖRTLÜ TOPLI GRUP PRİZ(Ç.K.)(KLEMENSLİ)	25	295,45
001 175 410002 01 00	DÖRTLÜ TOPLI GRUP PRİZ(Ç.K.)(1 MT)	12	454,55
001 175 410002 02 00	DÖRTLÜ TOPLI GRUP PRİZ(Ç.K.)(2 MT)	12	568,18
001 175 410002 03 00	DÖRTLÜ TOPLI GRUP PRİZ(Ç.K.)(3 MT)	12	659,09
001 175 410002 05 00	DÖRTLÜ TOPLI GRUP PRİZ(Ç.K.)(5 MT)	12	795,45
001 175 420001 00 00	DÖRTLÜ ANAHT. TOPLI GRUP PRİZ(Ç.K.)(KLEMENSLİ)	25	500,00
001 175 420002 01 00	DÖRTLÜ ANAHT. TOPLI GRUP PRİZ(Ç.K.)(1 MT)	12	659,09
001 175 420002 02 00	DÖRTLÜ ANAHT. TOPLI GRUP PRİZ(Ç.K.)(2 MT)	12	772,73
001 175 420002 03 00	DÖRTLÜ ANAHT. TOPLI GRUP PRİZ(Ç.K.)(3 MT)	12	863,64
001 175 420002 05 00	DÖRTLÜ ANAHT. TOPLI GRUP PRİZ(Ç.K.)(5 MT)	12	1.000,00
001 175 610001 00 00	ALTILI TOPLI GRUP PRİZ(Ç.K.)(KLEMENSLİ)	25	409,09
001 175 610002 01 00	ALTILI TOPLI GRUP PRİZ(Ç.K.)(1 MT)	12	568,18
001 175 610002 02 00	ALTILI TOPLI GRUP PRİZ(Ç.K.)(2 MT)	12	704,55
001 175 610002 03 00	ALTILI TOPLI GRUP PRİZ(Ç.K.)(3 MT)	12	795,45
001 175 610002 05 00	ALTILI TOPLI GRUP PRİZ(Ç.K.)(5 MT)	12	1.068,18
001 175 620001 00 00	ALTILI ANAHT. TOPLI GRUP PRİZ(Ç.K.)(KLEMENSLİ)	25	636,36
001 175 620002 01 00	ALTILI ANAHT. TOPLI GRUP PRİZ(Ç.K.)(1 MT)	12	795,45
001 175 620002 02 00	ALTILI ANAHT. TOPLI GRUP PRİZ(Ç.K.)(2 MT)	12	909,09
001 175 620002 03 00	ALTILI ANAHT. TOPLI GRUP PRİZ(Ç.K.)(3 MT)	12	1.022,73
001 175 620002 05 00	ALTILI ANAHT. TOPLI GRUP PRİZ(Ç.K.)(5 MT)	12	1.272,73
001 175 650001 00 00	ALTILI USB ANAHT. TOPLI GRUP PRİZ(Ç.K.)(KLEMENSLİ)	25	1.090,91
001 175 650002 02 00	ALTILI USB ANAHT. TOPLI GRUP PRİZ(Ç.K.)(2 MT)	12	1.454,55
001 175 650002 03 00	ALTILI USB ANAHT. TOPLI GRUP PRİZ(Ç.K.)(3 MT)	12	1.590,91
001 175 650002 05 00	ALTILI USB ANAHT. TOPLI GRUP PRİZ(Ç.K.)(5 MT)	12	1.772,73
<b>YENİ</b> 001 175 650101 00 00	ALTILI USB + TYPE-C ANAHT. TOPLI GRUP PRİZ(Ç.K.)(KLEMENSLİ)	25	1.200,00
<b>YENİ</b> 001 175 650102 02 00	ALTILI USB + TYPE-C ANAHT. TOPLI GRUP PRİZ(Ç.K.)(2 MT)	12	1.600,00
<b>YENİ</b> 001 175 650102 03 00	ALTILI USB + TYPE-C ANAHT. TOPLI GRUP PRİZ(Ç.K.)(3 MT)	12	1.750,00
<b>YENİ</b> 001 175 650102 05 00	ALTILI USB + TYPE-C ANAHT. TOPLI GRUP PRİZ(Ç.K.)(5 MT)	12	1.950,00



## Ri-tech Grup Prizler

Kod	Ürün Tanımı	Kutu Adedi	Fiyat (₺)
001 175 330001 00 00	ÜÇLÜ UPS GRUP PRİZ(Ç.K.)(KLEMENSLİ)	25	272,73
001 175 330002 02 00	ÜÇLÜ UPS GRUP PRİZ(Ç.K.)(2 MT)	12	568,18
001 175 330002 03 00	ÜÇLÜ UPS GRUP PRİZ(Ç.K.)(3 MT)	12	659,09
001 175 330002 05 00	ÜÇLÜ UPS GRUP PRİZ(Ç.K.)(5 MT)	12	795,45
001 175 340001 00 00	ÜÇLÜ ANAHT. UPS GRUP PRİZ(Ç.K.)(KLEMENSLİ)	25	477,27
001 175 340002 02 00	ÜÇLÜ ANAHT. UPS GRUP PRİZ(Ç.K.)(2 MT)	12	750,00
001 175 340002 03 00	ÜÇLÜ ANAHT. UPS GRUP PRİZ(Ç.K.)(3 MT)	12	840,91
001 175 340002 05 00	ÜÇLÜ ANAHT. UPS GRUP PRİZ(Ç.K.)(5 MT)	12	977,27
001 175 430001 00 00	DÖRTLÜ UPS GRUP PRİZ(Ç.K.)(KLEMENSLİ)	25	363,64
001 175 430002 02 00	DÖRTLÜ UPS GRUP PRİZ(Ç.K.)(2 MT)	12	636,36
001 175 430002 03 00	DÖRTLÜ UPS GRUP PRİZ(Ç.K.)(3 MT)	12	727,27
001 175 430002 05 00	DÖRTLÜ UPS GRUP PRİZ(Ç.K.)(5 MT)	12	863,64
001 175 440001 00 00	DÖRTLÜ ANAHT. UPS GRUP PRİZ(Ç.K.)(KLEMENSLİ)	25	568,18
001 175 440002 02 00	DÖRTLÜ ANAHT. UPS GRUP PRİZ(Ç.K.)(2 MT)	12	840,91
001 175 440002 03 00	DÖRTLÜ ANAHT. UPS GRUP PRİZ(Ç.K.)(3 MT)	12	931,82
001 175 440002 05 00	DÖRTLÜ ANAHT. UPS GRUP PRİZ(Ç.K.)(5 MT)	12	1.090,91
001 175 630001 00 00	ALTILI UPS GRUP PRİZ(Ç.K.)(KLEMENSLİ)	25	522,73
001 175 630002 02 00	ALTILI UPS GRUP PRİZ(Ç.K.)(2 MT)	12	818,18
001 175 630002 03 00	ALTILI UPS GRUP PRİZ(Ç.K.)(3 MT)	12	954,55
001 175 630002 05 00	ALTILI UPS GRUP PRİZ(Ç.K.)(5 MT)	12	1.227,27
001 175 640001 00 00	ALTILI ANAHT. UPS GRUP PRİZ(Ç.K.)(KLEMENSLİ)	25	727,27
001 175 640002 02 00	ALTILI ANAHT. UPS GRUP PRİZ(Ç.K.)(2 MT)	12	1.045,45
001 175 640002 03 00	ALTILI ANAHT. UPS GRUP PRİZ(Ç.K.)(3 MT)	12	1.159,09
001 175 640002 05 00	ALTILI ANAHT. UPS GRUP PRİZ(Ç.K.)(5 MT)	12	1.431,82

ALTILI ŞOK KORUMALI  
USB ANAHTAR TOPRAKLI  
GRUP PRİZ

ÜÇLÜ ŞOK KORUMALI  
ANAHTAR TOPRAKLI  
GRUP PRİZ

## Ri-tech Akım (Şok) Korumalı Grup Priz

Kod	Ürün Tanımı	Kutu Adedi	Fiyat (₺)
001 175 660002 15 00	ALTILI ŞOK KORUMA USB ANAHT. TOP.LI GRUP PRİZ(Ç.K.) (3X1.5 1.5 MT)	12	1.909,09
001 175 670002 15 00	ALTILI ŞOK KORUMA ANAHT. TOP.LI GRUP PRİZ(Ç.K.) (3X1.5 1.5 MT)	12	1.545,45
YENİ 001 175 370002 15 00	ÜÇLÜ ŞOK KORUMA ANAHT. TOP.LI GRUP PRİZ(Ç.K.) (3X1.5 1.5 MT)	12	1.318,18
YENİ 001 175 370002 03 00	ÜÇLÜ ŞOK KORUMA ANAHT. TOP.LI GRUP PRİZ(Ç.K.) (3X1.5 3 MT)	12	1.355,96
001 888 100004 00 00	TEKLİ ŞOK KORUMALI PRİZ	12	659,09

## Ri-tech USB Şarj

Kod	Ürün Tanımı	Kutu Adedi	Fiyat (₺)
001 888 100002 00 00	2'Li USB ŞARJ ADAPTÖR 2,4A	20	318,18
001 888 100003 00 00	USB + Type-C ŞARJ ADAPTÖR 2,4A	20	500,00

Kod	Ürün Tanımı	Kutu Adedi	Koli Adedi	Beyaz/Krem Fiyat (₺)	Metalik Fiyat (₺)	Ahşap Fiyat (₺)
2220 629 02XX	RİTA USB +Type-C TOPRAKLI PRİZ (ÇERÇEVE DAHİL)	8	-	700,00	1.059,04	1.217,89

\* Çoklu çerçeve ile kullanılamaz.

## Yeniliklerin müjdecisi...

Artık daha teknolojik bir hayat var...  
Ri-tech serisi yenilikçi ürünleri ile  
hayatınızı kolaylaştırmak için  
yanıbaşınızda...

# Olimpia Grup Prizler

## Ürün Listesi

Kod	Ürün Tanımı	Kutu Adedi	Fiyat (₺)
001 171 290001 00 00	İkili Topraksız Grup Priz (Klemensli) Olimpia	25	136,36
001 171 290002 02 00	İkili Topraksız Grup Priz (2Mt) Olimpia	12	318,18
001 171 290002 03 00	İkili Topraksız Grup Priz (3Mt) Olimpia	12	363,64
001 171 290002 05 00	İkili Topraksız Grup Priz (5Mt) Olimpia	12	454,55
001 171 210001 00 00	İkili Topraklı Grup Priz (Klemensli) Olimpia	25	184,09
001 171 210002 02 00	İkili Topraklı Grup Priz (2Mt) Olimpia	12	409,09
001 171 210002 03 00	İkili Topraklı Grup Priz (3M) Olimpia	12	490,91
001 171 210002 05 00	İkili Topraklı Grup Priz (5M) Olimpia	12	647,73
001 171 390001 00 00	Üçlü Topraksız Grup Priz (Klemensli) Olimpia	25	181,82
001 171 390002 02 00	Üçlü Topraksız Grup Priz (2Mt) Olimpia	12	363,64
001 171 390002 03 00	Üçlü Topraksız Grup Priz(3Mt) Olimpia	12	409,09
001 171 390002 05 00	Üçlü Topraksız Grup Priz (5Mt) Olimpia	12	500,00
001 171 310001 00 00	Üçlü Grup Priz Topraklı (Klemensli) Olimpia	25	215,91
001 171 310002 02 00	Üçlü Topraklı Grup Priz (2Mt) Olimpia	12	475,00
001 171 310002 03 00	Üçlü Topraklı Grup Priz (3Mt) Olimpia	12	561,36
001 171 310002 05 00	Üçlü Topraklı Grup Priz (5Mt) Olimpia	12	690,91
001 171 320001 00 00	Üçlü Topraklı Grup Priz (Klemensli Anahtarlı) Olimpia	25	368,18
001 171 320002 02 00	Üçlü Topraklı Grup Priz (Anahtarlı 2 Mt) Olimpia	12	613,64
001 171 320002 03 00	Üçlü Topraklı Grup Priz (Anahtarlı 3 Mt) Olimpia	12	695,45
001 171 320002 05 00	Üçlü Topraklı Grup Priz (Anahtarlı 5 Mt) Olimpia	12	818,18
001 171 340001 00 00	Üçlü Ups Grup Priz (Klemensli) Olimpia	25	245,45
001 171 330001 02 00	Üçlü Ups Grup Priz (2Mt) Olimpia	12	511,36
001 171 330001 03 00	Üçlü Ups Grup Priz (3Mt) Olimpia	12	593,18
001 171 330001 05 00	Üçlü Ups Grup Priz (5Mt) Olimpia	12	731,82
001 171 410001 00 00	Dörtlü Topraklı Grup Priz (Klemensli) Olimpia	25	280,68
001 171 410001 02 00	Dörtlü Topraklı Grup Priz (2Mt) Olimpia	12	539,77
001 171 410001 03 00	Dörtlü Topraklı Grup Priz (3Mt) Olimpia	12	626,14
001 171 410001 05 00	Dörtlü Topraklı Grup Priz (5Mt) Olimpia	12	755,68
001 171 410002 00 00	Dörtlü Topraklı Grup Priz (Klemensli-Anah. Olimpia)	25	475,00
001 171 410002 02 00	Dörtlü Topraklı Grup Priz (Anahtarlı 2 Mt) Olimpia	12	734,09
001 171 410002 03 00	Dörtlü Topraklı Grup Priz (Anahtarlı 3 Mt) Olimpia	12	820,45
001 171 410002 05 00	Dörtlü Topraklı Grup Priz (Anahtarlı 5 Mt) Olimpia	12	950,00
001 171 610001 00 00	Altılı Grup Priz Top.lı (Klemensli) Olimpia	25	388,64
001 171 610001 02 00	Altılı Topraklı Grup Priz (2 Mt) Olimpia	12	669,32
001 171 610001 03 00	Altılı Topraklı Grup Priz (3 Mt) Olimpia	12	755,68
001 171 610001 05 00	Altılı Topraklı Grup Priz (5 Mt) Olimpia	12	1.014,77
001 171 610002 00 00	Altılı Topraklı Grup Priz (Klemensli-Anahtarlı) Olimpia	25	604,55
001 171 610002 02 00	Altılı Topraklı Grup Priz (Anahtarlı 2 Mt) Olimpia	12	863,64
001 171 610002 03 00	Altılı Topraklı Grup Priz (Anahtarlı 3 Mt) Olimpia	12	971,59
001 171 610002 05 00	Altılı Topraklı Grup Priz (Anahtarlı 5 Mt) Olimpia	12	1.209,09
001 170 110001 00 00	10'lu Topraklı Grup Priz (Klemensli)	20	1.107,05

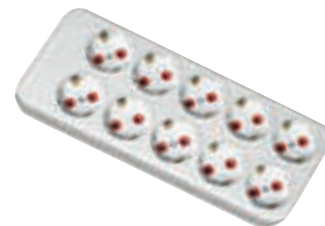
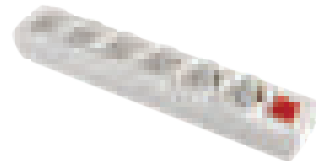
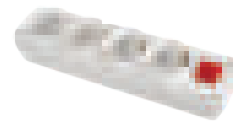

## Olimpia Fiş Prizler

### Ürün Listesi



CE

Ürün Kodu	001 170 012001 00 00
Ürün Adı	Olimpia Topraklı Erkek Fiş (Kuyruklu)
Kutu Adedi	50
Fiyatı	90,91 ₺



CE

Ürün Kodu	001 170 010001 00 00
Ürün Adı	Olimpia Erkek Fiş
Kutu Adedi	50
Fiyatı	63,64 ₺



CE

Ürün Kodu	001 170 013001 00 00
Ürün Adı	Olimpia Topraklı Erkek Fiş Ups (Kuyruklu)
Kutu Adedi	50
Fiyatı	95,45 ₺



CE

Ürün Kodu	001 170 020001 00 00
Ürün Adı	Olimpia Dişi Fiş
Kutu Adedi	50
Fiyatı	47,73 ₺



CE

Ürün Kodu	001 170 011001 00 00
Ürün Adı	Olimpia Topraklı Erkek Fiş
Kutu Adedi	50
Fiyatı	86,36 ₺



CE

Ürün Kodu	001 170 021001 00 00
Ürün Adı	Olimpia Topraklı Dişi Fiş
Kutu Adedi	25
Fiyatı	90,91 ₺



CE

Ürün Kodu	001 170 014001 00 00
Ürün Adı	Olimpia Topraklı Erkek Fiş Ups
Kutu Adedi	50
Fiyatı	90,91 ₺



Ürün Kodu	001 888 000001 00 00
Ürün Adı	Prizmatik Priz Koruma Kapağı
Kutu Adedi	100
Fiyatı	34,09 ₺



CE

Ürün Kodu	001 170 033006 00 00
Ürün Adı	Olimpia İkili Topraklı Fiş-Priz (Düz Tip Beyaz)
Kutu Adedi	28
Fiyatı	190,91 ₺



CE

Ürün Kodu	001 170 033007 00 00
Ürün Adı	Olimpia İkili Topraklı Fiş-Priz (Düz Tip Beyaz Anahtarlı)
Kutu Adedi	28
Fiyatı	318,18 ₺



CE

Ürün Kodu	001 170 033006 00 11
Ürün Adı	Olimpia İkili Topraklı Fiş-Priz (Düz Tip Siyah)
Kutu Adedi	28
Fiyatı	190,91 ₺



CE

Ürün Kodu	001 170 033007 00 11
Ürün Adı	Olimpia İkili Topraklı Fiş-Priz (Düz Tip Siyah Anahtarlı)
Kutu Adedi	28
Fiyatı	318,18 ₺

## Plus Fiş Prizler

### Ürün Listesi



Ürün Kodu	001 170 051001 00 00
Ürün Adı	Plus Topraklı Erkek Fiş
Kutu Adedi	50/600
Fiyatı	88,64 ₺

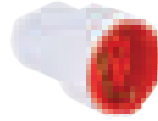

Ürün Kodu	001 170 061001 00 00
Ürün Adı	Plus Topraklı Dişi Fiş
Kutu Adedi	50
Fiyatı	95,45 ₺



Ürün Kodu	001 170 050001 00 00
Ürün Adı	Plus Erkek Fiş
Kutu Adedi	50/600
Fiyatı	65,91 ₺

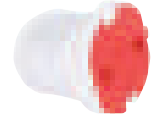

Ürün Kodu	001 170 060001 00 00
Ürün Adı	Plus Dişi Fiş
Kutu Adedi	50/600
Fiyatı	50,00 ₺

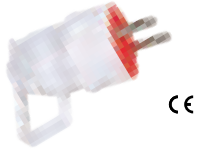

Ürün Kodu	001 170 011002 00 00
Ürün Adı	Plus Kulplu Topraklı Erkek Fiş
Kutu Adedi	50
Fiyatı	93,18 ₺



Ürün Kodu	001 170 030002 00 00
Ürün Adı	Plus Adaptör Fiş, Priz (İngiliz Tip)
Kutu Adedi	50/500
Fiyatı	113,64 ₺



Ürün Kodu	001 170 033001 00 00
Ürün Adı	Plus Topraklı Üçlü Fiş-Priz (Yonca Tip) (S/A)
Kutu Adedi	12/144
Fiyatı	331,82 ₺



Ürün Kodu	001 170 033002 00 00
Ürün Adı	Plus Topraklı Üçlü Fiş-Priz (Yonca Tip) (S/U)
Kutu Adedi	36
Fiyatı	318,18 ₺



Ürün Kodu	001 170 033003 00 00
Ürün Adı	Plus İkili Topraklı Fiş-Priz (Düz Tip)
Kutu Adedi	48
Fiyatı	295,45 ₺



Ürün Kodu	001 170 033005 00 00
Ürün Adı	Plus Üçlü Topraklı Fiş-Priz (Düz Tip)
Kutu Adedi	40
Fiyatı	363,64 ₺



Ürün Kodu	001 170 030001 00 00
Ürün Adı	Plus Arapuar Anahtar
Kutu Adedi	50/600
Fiyatı	54,55 ₺



Ürün Kodu	001 170 033004 00 00
Ürün Adı	Plus Üçlü Topraklı Fiş-Priz (Düz Tip Anahtarlı)
Kutu Adedi	36
Fiyatı	477,27 ₺

## Plus Fiş Prizler

### Ürün Listesi



CE

Ürün Kodu	001170 011002 00 11
Ürün Adı	Plus Kulplu Topraklı Erkek Fiş Siyah
Kutu Adedi	50
Fiyatı	93,18 ₺



CE

Ürün Kodu	001170 050001 00 11
Ürün Adı	Plus Erkek Fiş Siyah
Kutu Adedi	50
Fiyatı	65,91 ₺



CE

Ürün Kodu	001170 051001 00 11
Ürün Adı	Plus Topraklı Erkek Fiş Siyah
Kutu Adedi	50
Fiyatı	88,64 ₺



CE

Ürün Kodu	001170 060001 00 11
Ürün Adı	Plus Dişi Fiş Siyah
Kutu Adedi	50
Fiyatı	50,00 ₺



CE

Ürün Kodu	001170 061001 00 11
Ürün Adı	Plus Topraklı Dişi Fiş Siyah
Kutu Adedi	50
Fiyatı	95,45 ₺



CE

Ürün Kodu	001170 030001 00 11
Ürün Adı	Plus Arapuar Anahtar Siyah
Kutu Adedi	50
Fiyatı	54,55 ₺



CE

Ürün Kodu	001170 033002 00 11
Ürün Adı	Plus Topraklı Üçlü Fiş-Priz (Yonca Tip) Siyah
Kutu Adedi	36
Fiyatı	318,18 ₺



CE

Ürün Kodu	001170 033003 00 11
Ürün Adı	Plus İkili Topraklı Fiş-Priz Düz Tip Siyah
Kutu Adedi	48
Fiyatı	295,45 ₺



CE

Ürün Kodu	001170 033005 00 11
Ürün Adı	Plus Üçlü Topraklı Fiş-Priz (Düz Tip) Siyah
Kutu Adedi	40
Fiyatı	363,64 ₺



CE

Ürün Kodu	001170 033004 00 11
Ürün Adı	Plus Üçlü Topraklı Anahtarlı Fiş-Priz (Düz Tip) Siyah
Kutu Adedi	36
Fiyatı	477,27 ₺



CE

Ürün Kodu	001170 030002 00 11
Ürün Adı	Plus Adaptör Fiş, Priz (İngiliz Tip) Siyah
Kutu Adedi	50
Fiyatı	113,64 ₺

# KABLO KANALLARI PLASTİK, TESİSAT ve AYDINLATMA GRUBU



YENİ

**LED**  
için ÖZEL  
13x12,5mm



Kendinden Kapaklı  
Intrinsic Cover

Kendinden Yapışkanlı  
Self-Adhesive















Kendinden Yapışkanlı  
Self-Adhesive

Ürün Kodu	Ürün Adı	Amb. (Kutu)	Amb. Birimi	Fiyat (₺)
<b>LED İÇİN KENDİNDEN KAPAKLI KABLO KANALI</b>				IP40
001 004 013012 20 44	13x12,5 MM KABLO KANALI ŞEFFAF KANAL (LED İÇİN)	300	mt.	65,76
<b>CANALEX SERİSİ TSE'Lİ KAPALI TİP KABLO KANALLARI (KUTULU)</b>				CE IP40
001 156 012012 20 00	12x12 MM KABLO KANALI (CANALEX)	250	mt.	16,67
001 156 015010 20 00	15x10 MM KABLO KANALI (CANALEX)	250	mt.	17,04
001 156 016016 20 00	16x16 MM KABLO KANALI (CANALEX)	250	mt.	18,19
001 156 020010 20 00	20x10 MM KABLO KANALI (CANALEX)	200	mt.	19,63
001 156 020015 20 00	20x15 MM KABLO KANALI (CANALEX)	200	mt.	27,04
001 156 025016 20 00	25x16 MM KABLO KANALI (CANALEX)	150	mt.	27,78
001 156 025025 20 00	25x25 MM KABLO KANALI (CANALEX)	100	mt.	40,74
001 156 040016 20 00	40x16 MM KABLO KANALI (CANALEX)	100	mt.	49,26
001 156 040025 20 00	40x25 MM KABLO KANALI (CANALEX)	80	mt.	53,70
001 156 040040 20 00	40x40 MM KABLO KANALI (CANALEX)	50	mt.	68,90
001 156 060040 20 00	60x40 MM KABLO KANALI (CANALEX)	40	mt.	103,70
001 156 060060 20 00	60x60 MM KABLO KANALI (CANALEX)	32	mt.	159,26
001 156 080040 20 00	80x40 MM KABLO KANALI (CANALEX)	30	mt.	160,19
001 156 080060 20 00	80x60 MM KABLO KANALI (CANALEX)	24	mt.	188,89
001 156 100040 20 00	100x40 MM KABLO KANALI (CANALEX)	24	mt.	196,30
001 156 100060 20 00	100x60 MM KABLO KANALI (CANALEX)	20	mt.	259,26
<b>CANALEX SERİSİ KAPALI TİP KABLO KANALLARI (YAPIŞKAN BANTLI)</b>				IP40
001 157 012012 20 00	12x12 MM KABLO KANALI CANALEX (YAPIŞKAN BANTLI)	250	mt.	20,00
001 157 015010 20 00	15x10 MM KABLO KANALI CANALEX (YAPIŞKAN BANTLI)	230	mt.	20,44
001 157 016016 20 00	16x16 MM KABLO KANALI CANALEX (YAPIŞKAN BANTLI)	240	mt.	21,82
001 157 020010 20 00	20x10 MM KABLO KANALI CANALEX (YAPIŞKAN BANTLI)	200	mt.	23,56
001 157 020015 20 00	20x15 MM KABLO KANALI CANALEX (YAPIŞKAN BANTLI)	180	mt.	32,44
001 157 025016 20 00	25x16 MM KABLO KANALI CANALEX (YAPIŞKAN BANTLI)	150	mt.	33,33
001 157 025025 20 00	25x25 MM KABLO KANALI CANALEX (YAPIŞKAN BANTLI)	100	mt.	48,89
001 157 040016 20 00	40x16 MM KABLO KANALI CANALEX (YAPIŞKAN BANTLI)	100	mt.	59,11
001 157 040025 20 00	40x25 MM KABLO KANALI CANALEX (YAPIŞKAN BANTLI)	80	mt.	64,44
001 157 040040 20 00	40x40 MM KABLO KANALI CANALEX (YAPIŞKAN BANTLI)	50	mt.	82,68
001 157 060040 20 00	60x40 MM KABLO KANALI CANALEX (YAPIŞKAN BANTLI)	40	mt.	124,44
<b>EKO SERİSİ TSE'Lİ KAPALI TİP KABLO KANALLARI</b>				CE IP40
001 014 010008 20 00	10x08 MM KABLO KANALI EKO	330	mt.	18,52
001 014 012012 20 00	12x12 MM KABLO KANALI EKO	250	mt.	18,70
001 014 015010 20 00	15x10 MM KABLO KANALI EKO	250	mt.	18,95
001 014 015015 20 00	15x15 MM KABLO KANALI EKO	250	mt.	27,78
001 014 016016 20 00	16x16 MM KABLO KANALI EKO	250	mt.	25,93
001 014 020010 20 00	20x10 MM KABLO KANALI EKO	200	mt.	22,09
001 014 025016 20 00	25x16 MM KABLO KANALI EKO	150	mt.	33,20
001 014 025025 20 00	25x25 MM KABLO KANALI EKO	100	mt.	43,79
001 014 025040 20 00	25x40 MM KABLO KANALI EKO	80	mt.	99,01
001 014 930010 20 00	30x10 MM KABLO KANALI EKO (BÖLMELİ)	140	mt.	48,98
001 014 030015 20 00	30x15 MM KABLO KANALI EKO	140	mt.	44,56
001 014 930016 20 00	30x16 MM KABLO KANALI EKO (BÖLMELİ)	140	mt.	62,40
001 014 030016 20 00	30x16 MM KABLO KANALI EKO	140	mt.	51,99
001 014 030025 20 00	30x25 MM KABLO KANALI EKO	80	mt.	73,26
001 014 030030 20 00	30x30 MM KABLO KANALI EKO	80	mt.	66,39
001 014 940016 20 00	40x16 MM KABLO KANALI EKO (BÖLMELİ)	100	mt.	72,75
001 014 040016 20 00	40x16 MM KABLO KANALI EKO	100	mt.	53,29
001 014 040025 20 00	40x25 MM KABLO KANALI EKO	80	mt.	65,79
001 014 040040 20 00	40x40 MM KABLO KANALI EKO	50	mt.	74,89
001 014 040060 20 00	40x60 MM KABLO KANALI EKO	40	mt.	194,50
001 014 960025 20 00	60x25 MM KABLO KANALI EKO (BÖLMELİ)	40	mt.	132,87
001 014 060040 20 00	60x40 MM KABLO KANALI EKO	40	mt.	119,41
001 014 050050 20 00	50x50 MM KABLO KANALI EKO	30	mt.	169,76
001 014 060060 20 00	60x60 MM KABLO KANALI EKO	32	mt.	162,15
001 014 075075 20 00	75x75 MM KABLO KANALI EKO	28	mt.	270,22
001 014 080040 20 00	80x40 MM KABLO KANALI EKO	30	mt.	207,84
001 014 080060 20 00	80x60 MM KABLO KANALI EKO	24	mt.	202,16
001 014 100040 20 00	100x40 MM KABLO KANALI EKO (PRİZ SETİ TAKILABİLİR)	24	mt.	206,40
001 014 100037 20 00	100x37 MM KABLO KANALI İÇTEN KAPAKLI KANAL EKO FOLYOLU (PRİZ SETİ TAKILABİLİR)	30	mt.	229,63
001 014 100050 20 00	100x50 MM KABLO KANALI İÇTEN KAPAKLI KANAL EKO FOLYOLU (PRİZ SETİ TAKILABİLİR)	20	mt.	240,74
001 014 100060 20 00	100x60 MM KABLO KANALI EKO (PRİZ SETİ TAKILABİLİR)	20	mt.	277,78
001 014 120060 20 00	120x60 MM KABLO KANALI EKO	16	mt.	407,41
001 014 100100 20 00	100x100 MM KABLO KANALI EKO	20	mt.	481,48
<b>EKO SERİSİ KAPALI TİP KABLO KANALLARI (YAPIŞKAN BANTLI)</b>				IP40
001 004 009005 20 00	9x5 MM KABLO KANALI KEN.KAPAKLI	500	mt.	30,19
001 004 010007 20 44	9,5x7 MM KABLO KANALI ŞEFFAF KANAL	500	mt.	43,63
001 004 012007 20 00	12x7,5 MM KABLO KANALI KENDİNDEN KAPAKLI	350	mt.	30,98
001 004 013012 20 00	13x12,5 MM KABLO KANALI KENDİNDEN KAPAKLI	300	mt.	37,54
001 004 010008 20 00	10x8 MM KABLO KANALI EKO (YAPIŞKAN BANTLI)	330	mt.	21,12
001 004 010010 20 00	10x10 MM KABLO KANALI EKO KENDİNDEN KAPAKLI (YAPIŞKAN BANTLI)	320	mt.	32,39
001 004 012012 20 00	12x12 MM KABLO KANALI EKO (YAPIŞKAN BANTLI)	250	mt.	25,93
001 004 015010 20 00	15x10 MM KABLO KANALI EKO (YAPIŞKAN BANTLI)	230	mt.	26,67
001 004 016016 20 00	16x16 MM KABLO KANALI EKO (YAPIŞKAN BANTLI)	240	mt.	31,34
001 004 020010 20 00	20x10 MM KABLO KANALI EKO (YAPIŞKAN BANTLI)	180	mt.	29,63
001 004 025016 20 00	25x16 MM KABLO KANALI EKO (YAPIŞKAN BANTLI)	150	mt.	45,19
001 004 025025 20 00	25x25 MM KABLO KANALI EKO (YAPIŞKAN BANTLI)	100	mt.	59,26
001 004 025040 20 00	25x40 MM KABLO KANALI EKO (YAPIŞKAN BANTLI)	80	mt.	114,81
001 004 930010 20 00	30x10 MM KABLO KANALI EKO (YAPIŞKAN BANTLI) (BÖLMELİ)	140	mt.	56,29
001 004 030016 20 00	30x16 MM KABLO KANALI EKO (YAPIŞKAN BANTLI)	140	mt.	59,26
001 004 030025 20 00	30x25 MM KABLO KANALI EKO (YAPIŞKAN BANTLI)	80	mt.	83,33
001 004 040016 20 00	40x16 MM KABLO KANALI EKO (YAPIŞKAN BANTLI)	100	mt.	66,67
001 004 040025 20 00	40x25 MM KABLO KANALI EKO (YAPIŞKAN BANTLI)	80	mt.	84,78
001 004 040040 20 00	40x40 MM KABLO KANALI EKO (YAPIŞKAN BANTLI)	50	mt.	98,83
001 004 060040 20 00	60x40 MM KABLO KANALI EKO (YAPIŞKAN BANTLI)	40	mt.	155,56



Ürün Kodu	Ürün Adı	Amb. (Kutu)	Amb. Birimi	Fiyat (₺)
<b>MEKS SERİSİ TSE'Lİ KAPALI TİP KABLO KANALLARI</b>				
001 002 015015 20 00	15x15 MM KABLO KANALI MEKS	250	mt.	32,96
001 002 016016 20 00	16x16 MM KABLO KANALI MEKS	250	mt.	33,33
001 002 025016 20 00	25x16 MM KABLO KANALI MEKS	150	mt.	48,15
001 002 025025 20 00	25x25 MM KABLO KANALI MEKS	100	mt.	62,96
001 002 030015 20 00	30x15 MM KABLO KANALI MEKS	140	mt.	57,41
001 002 030030 20 00	30x30 MM KABLO KANALI MEKS	80	mt.	81,48
001 002 040017 20 00	40x17 MM KABLO KANALI TAM KAPAKLI MEKS	100	mt.	91,49
001 002 940017 20 00	40x17 MM KABLO KANALI TAM KAPAKLI MEKS (BÖLMELİ)	100	mt.	97,74
001 002 040025 20 00	40x25 MM KABLO KANALI MEKS	80	mt.	91,60
001 002 040040 20 00	40x40 MM KABLO KANALI MEKS	50	mt.	106,53
001 002 960025 20 00	60x25 MM KABLO KANALI MEKS (BÖLMELİ)	40	mt.	159,26
001 002 060040 20 00	60x40 MM KABLO KANALI MEKS	40	mt.	166,67
001 002 080060 20 00	80x60 MM KABLO KANALI MEKS	24	mt.	266,67
001 002 100040 20 00	100x40 MM KABLO KANALI MEKS (PRİZ SETİ TAKILABİLİR)	24	mt.	285,19
001 002 100048 20 00	100x48 MM KABLO KANALI MEKS (PRİZ SETİ TAKILABİLİR)	24	mt.	370,37
001 002 100060 20 00	100x60 MM KABLO KANALI MEKS (PRİZ SETİ TAKILABİLİR)	20	mt.	377,78
001 002 120060 20 00	120x60 MM KABLO KANALI MEKS	16	mt.	518,52
<b>MEKS SERİSİ İÇTEN KAPAKLI KAPALI TİP KABLO KANALLARI</b>				
001 002 100037 20 00	100x37 MM KABLO KANALI MEKS (İÇTEN KAPAKLI)(FOLYOLU)	30	mt.	314,81
001 002 100041 20 00	100x41 MM KABLO KANALI MEKS (İÇTEN KAPAKLI)(FOLYOLU)	24	mt.	318,52
001 002 100050 20 00	100x50 MM KABLO KANALI MEKS (İÇTEN KAPAKLI)(FOLYOLU)	20	mt.	333,33
001 002 120070 20 00	120x70 MM KABLO KANALI (İÇTEN KAPAKLI)(AKSESUARSIZ)	16	mt.	518,52
001 002 170070 20 00	170x70 MM KABLO KANALI (İÇTEN KAPAKLI)(AKSESUARSIZ)	12	mt.	618,52
001 002 250070 20 00	250x70 MM KABLO KANALI (İÇTEN KAPAKLI)(AKSESUARSIZ)	8	mt.	962,96
<b>MEKSPUS SERİSİ KAPALI TİP KABLO KANALLARI</b>				
001 003 100037 20 00	100x37 MM KABLO KANALI (İÇTEN KAPAKLI)	30	mt.	333,33
001 003 100041 20 00	100x41 MM KABLO KANALI (İÇTEN KAPAKLI)	24	mt.	340,74
001 003 100050 20 00	100x50 MM KABLO KANALI (İ. KAP.)(ET KALINLIĞI 2MM)	20	mt.	370,37
001 006 100050 20 00	100x50 MM KABLO KANALI (İÇTEN KAPAKLI)(KAİDESİZ SERİ)	20	mt.	444,44
001 003 120070 20 00	120x70 MM KABLO KANALI (İÇTEN KAPAKLI)(AKSESUARSIZ)	16	mt.	592,59
001 003 170050 20 00	170x50 MM KABLO KANALI (İÇTEN KAPAKLI)	12	mt.	740,74
001 003 170070 20 00	170x70 MM KABLO KANALI (İÇTEN KAPAKLI)(AKSESUARSIZ)	12	mt.	907,41
001 003 250070 20 00	250x70 MM KABLO KANALI (İÇTEN KAPAKLI)(AKSESUARSIZ)	8	mt.	1.055,56
<b>MEKS SERİSİ KLİMA KANALI ve AKSESUARLARI</b>				
001 002 075060 20 00	75x60 MM KLİMA KANALI	30	mt.	222,22
001 050 030002 00 00	KLİMA KANALI KABLO TUTUCUSU	60	ad.	36,11
001 043 075060 00 00	KLİMA KANALI EK PARÇASI	40	ad.	36,11
001 039 075060 00 00	KLİMA KANALI İÇ KÖŞE	24	ad.	77,04
001 040 075060 00 00	KLİMA KANALI DIŞ KÖŞE	24	ad.	77,04
001 042 075060 00 00	KLİMA KANALI L KÖŞE	18	ad.	77,04
001 050 030001 00 00	KLİMA KANALI DUVAR GEÇİŞİ	60	ad.	48,15
001 044 075060 01 00	KLİMA KANALI İÇ SONLAMA	30	ad.	77,04
001 044 075060 02 00	KLİMA KANALI DIŞ SONLAMA	18	ad.	77,04
<b>TAVAN KÖŞE KANALI (23x23) ve AKSESUARLARI</b>				
001 002 023023 20 00	23x23 MM TAVAN KÖŞE KANALI	120	mt.	91,87
001 041 023023 00 00	23x23 MM T PARÇASI	60	ad.	22,22
001 042 023023 00 00	23x23 MM 90 L KÖŞE	60	ad.	22,22
001 043 023023 00 00	23x23 MM EK PARÇA	100	ad.	17,78
001 044 023023 00 00	23x23 MM UÇ TAPA	100	ad.	17,78
<b>SÜPÜRGELİK KABLO KANALLARI ve AKSESUARLARI</b>				
001 010 000200 20 00	50'LİK FUGALI SÜPÜRGELİK	60	mt.	92,86
001 014 974020 20 00	74x20 MM KABLO KANALI EKO (BÖLMELİ)	50	mt.	178,77
001 039 074020 00 00	74x20 İÇ KÖŞE	20	ad.	55,56
001 040 074020 00 00	74x20 DIŞ KÖŞE	20	ad.	55,56
001 041 074020 00 00	74x20 T KÖŞE	30	ad.	64,81
001 042 074020 01 00	74x90 20 L KÖŞE	40	ad.	64,81
001 043 074020 00 00	74x20 EK PARÇA	50	ad.	30,09
001 044 074020 00 00	74x20 UÇ TAPA	50	ad.	30,09
001 047 017420 00 00	74x20 PRİZ MONTAJ KASASI	6	ad.	175,93
001 047 017421 00 00	74x20 1'Lİ PRİZ MONTAJ KASASI	12	ad.	329,32
001 002 975022 20 00	75x22 MM KABLO KANALI (BÖLMELİ)	50	mt.	247,04
001 039 075022 00 00	75x22 MM İÇ KÖŞE	20	ad.	27,78
001 040 075022 00 00	75x22 MM DIŞ KÖŞE	20	ad.	27,78
001 044 075022 01 00	75x22 MM SAĞ SONLAMA	30	ad.	42,60
001 044 075022 02 00	75x22 MM SOL SONLAMA	20	ad.	41,88
001 043 075022 00 00	75x22 MM EK PARÇASI	100	ad.	38,41
<b>TEZGAH SÜPÜRGELİĞİ</b>				
001 011 000100 00 00	25'LİK TEZGAH SÜPÜRGELİĞİ 100CM	60	mt.	104,21
<b>BALIK SIRTI KANALLARI</b>				
001 002 050013 20 17	50x13 MM BALIK SIRTI KANAL (ZEMİN İÇİN)	60	mt.	111,45
001 002 060015 20 17	60x15 MM BALIK SIRTI KANAL (ZEMİN İÇİN)	40	mt.	124,47
001 002 075018 20 17	75x18 MM BALIK SIRTI KANAL (ZEMİN İÇİN)	30	mt.	203,24
001 002 090020 20 17	90x20 MM BALIK SIRTI KANAL (ZEMİN İÇİN)	20	mt.	255,86
001 004 050013 20 17	50x13 MM KABLO KANALI BALIK SIRTI (YAPIŞKAN BANTLI)	60	mt.	123,03
001 004 060015 20 17	60x15 MM KABLO KANALI BALIK SIRTI (YAPIŞKAN BANTLI)	40	mt.	136,50
001 004 075018 20 17	75x18 MM KABLO KANALI BALIK SIRTI (YAPIŞKAN BANTLI)	30	mt.	225,36
001 004 090020 20 17	90x20 MM KABLO KANALI BALIK SIRTI (YAPIŞKAN BANTLI)	20	mt.	284,69





Ürün Kodu	Ürün Adı	Amb. (Kutu)	Amb. Birimi	Fiyat (₺)
<b>H.FREE FLARET SERİSİ KAPALI TİP KABLO KANALLARI</b>				
  				
001 060 100050 20 00	100x50 MM KABLO KANALI İÇTEN KAPAKLI HALOJEN FREE	20	mt.	1.119,00
001 061 100050 20 00	100x50 MM KABLO KANALI ARA BÖLME HALOJEN FREE	150	mt.	129,96
001 039 100050 11 00	100x50-37 MM KABLO KANALI İÇ KÖŞE(HAREKETLİ) HALOJEN FREE	12	ad.	115,74
001 040 100050 11 00	100x50 MM KABLO KANALI DIŞ KÖŞE(HAREKETLİ) HALOJEN FREE	10	ad.	115,74
001 041 100050 11 00	100x50 MM KABLO KANALI T PARÇASI HALOJEN FREE	10	ad.	125,00
001 042 100050 11 00	100x50 MM KABLO KANALI 90 L KÖŞE HALOJEN FREE	10	ad.	125,00
001 043 100050 11 00	100x50 MM KABLO KANALI EK PARÇA(ÜÇLÜ SET) HALOJEN FREE	100	ad.	53,50
001 044 100050 11 00	100x50 MM KABLO KANALI UÇ TAPA HALOJEN FREE	40	ad.	53,50
001 047 100001 11 00	PMS(100x37/50)(45X45)(1LÜ) HALOJEN FREE	30	ad.	69,63
001 047 100002 11 00	PMS(100x37/50)(45X45)(2LÜ) HALOJEN FREE	16	ad.	100,00
001 047 100003 11 00	PMS(100x37/50)(45X45)(3LÜ) HALOJEN FREE	14	ad.	141,22
<b>H.FREE FLARET SERİSİ KAPALI TİP KABLO KANALLARI</b>				
  				
001 060 025016 20 00	25x16 MM KABLO KANALI HALOJEN FREE	150	mt.	211,36
001 060 025025 20 00	25x25 MM KABLO KANALI HALOJEN FREE	100	mt.	233,36
001 060 040025 20 00	40x25 MM KABLO KANALI HALOJEN FREE	80	mt.	352,93
001 060 040040 20 00	40x40 MM KABLO KANALI HALOJEN FREE	50	mt.	399,94
<b>25x16 H.FREE FLARET KANAL AKSESUARLARI</b>				
  				
001 039 025016 11 00	25x16 MM İÇ KÖŞE	40	ad.	25,63
001 040 025016 11 00	25x16 MM DIŞ KÖŞE	40	ad.	25,63
001 041 025016 11 00	25x16 MM T PARÇASI	30	ad.	39,06
001 042 025016 11 00	25x16 MM 90 L KÖŞE	80	ad.	39,06
001 043 025016 11 00	25x16 MM EK PARÇA	100	ad.	23,44
001 044 025016 11 00	25x16 MM UÇ TAPA	100	ad.	23,44
<b>25x25 H.FREE FLARET KANAL AKSESUARLARI</b>				
  				
001 039 025025 11 00	25x25 MM İÇ KÖŞE	40	ad.	28,44
001 040 025025 11 00	25x25 MM DIŞ KÖŞE	40	ad.	28,44
001 041 025025 11 00	25x25 MM T PARÇASI	30	ad.	47,50
001 042 025025 11 00	25x25 MM 90 L KÖŞE	50	ad.	47,50
001 043 025025 11 00	25x25 MM EK PARÇA	100	ad.	26,56
001 044 025025 11 00	25x25 MM UÇ TAPA	100	ad.	26,56
<b>40x25 H.FREE FLARET KANAL AKSESUARLARI</b>				
  				
001 039 040025 11 00	40x25 MM İÇ KÖŞE	24	ad.	72,88
001 040 040025 11 00	40x25 MM DIŞ KÖŞE	30	ad.	72,88
001 041 040025 11 00	40x25 MM T PARÇASI	18	ad.	90,31
001 042 040025 11 00	40x25 MM 90 L KÖŞE	24	ad.	90,31
001 043 040025 11 00	40x25 MM EK PARÇA	70	ad.	55,15
001 044 040025 11 00	40x25 MM UÇ TAPA	25	ad.	55,15
<b>40x40 H.FREE FLARET KANAL AKSESUARLARI</b>				
  				
001 039 040040 11 00	40x40 MM İÇ KÖŞE	18	ad.	80,00
001 040 040040 11 00	40x40 MM DIŞ KÖŞE	16	ad.	80,00
001 041 040040 11 00	40x40 MM T PARÇASI	48	ad.	82,66
001 042 040040 11 00	40x40 MM 90 L KÖŞE	60	ad.	82,66
001 043 040040 11 00	40x40 MM EK PARÇA	100	ad.	54,31
001 044 040040 11 00	40x40 MM UÇ TAPA	25	ad.	54,31



Ürün Kodu	Ürün Adı	Amb. (Kutu)	Amb. Birimi	Fiyat (₺)
<b>BALIK SIRTI 60x15 AKSESUARLARI</b>				
001 042 060015 00 17	60x15 MM BALIK SIRTI KANAL L KÖŞE	24	ad.	44,44
001 043 060015 00 17	60x15 MM BALIK SIRTI KANAL EK PARÇASI	50	ad.	22,22
001 044 060015 00 17	60x15 MM BALIK SIRTI KANAL SONLAMA KAPAĞI	50	ad.	22,22
001 041 060015 00 17	60x15 MM BALIK SIRTI KANAL T KÖŞE	10	ad.	57,78
<b>BALIK SIRTI 75x18 AKSESUARLARI</b>				
001 042 075018 00 17	75x18 MM BALIK SIRTI KANAL L KÖŞE	15	ad.	66,67
001 043 075018 00 17	75x18 MM BALIK SIRTI KANAL EK PARÇASI	50	ad.	26,67
001 044 075018 00 17	75x18 MM BALIK SIRTI KANAL SONLAMA KAPAĞI	50	ad.	26,67
001 041 075018 00 17	75x18 MM BALIK SIRTI KANAL T KÖŞE	8	ad.	66,67
<b>BALIK SIRTI 90x20 AKSESUARLARI</b>				
001 042 090020 00 17	90x20 MM BALIK SIRTI KANAL KANAL L KÖŞE	20	ad.	71,11
001 043 090020 00 17	90x20 MM BALIK SIRTI KANAL EK PARÇASI	50	ad.	26,67
001 044 090020 00 17	90x20 MM BALIK SIRTI KANAL SONLAMA KAPAĞI	50	ad.	26,67
001 041 090020 00 17	90x20 MM BALIK SIRTI KANAL T KÖŞE	12	ad.	71,11
<b>12X12 KANAL AKSESUARLARI</b>   IP40				
001 039 012012 00 00	12x12 MM İÇ KÖŞE	60	ad.	16,20
001 040 012012 00 00	12x12 MM DIŞ KÖŞE	60	ad.	16,20
001 041 012012 00 00	12x12 MM T KÖŞE	60	ad.	17,13
001 042 012012 00 00	12x12 MM 90 L KÖŞE	60	ad.	17,13
001 044 012012 00 00	12x12 MM UÇ TAPA	100	ad.	15,74
001 043 012012 00 00	12x12 MM EK PARÇASI	100	ad.	15,74
<b>15X10 KANAL AKSESUARLARI</b>   IP40				
001 039 015010 00 00	15x10 MM İÇ KÖŞE	60	ad.	17,59
001 040 015010 00 00	15x10 MM DIŞ KÖŞE	60	ad.	17,59
001 041 015010 00 00	15x10 MM T KÖŞE	60	ad.	18,52
001 042 015010 00 00	15x10 MM 90 L KÖŞE	60	ad.	18,52
001 044 015010 00 00	15x10 MM UÇ TAPA	100	ad.	16,67
001 043 015010 00 00	15x10 MM EK PARÇASI	100	ad.	16,67
<b>20X10 KANAL AKSESUARLARI</b>   IP40				
001 039 020010 00 00	20x10 MM İÇ KÖŞE	60	ad.	18,06
001 040 020010 00 00	20x10 MM DIŞ KÖŞE	60	ad.	18,06
001 041 020010 00 00	20x10 MM T KÖŞE	30	ad.	22,22
001 042 020010 00 00	20x10 MM 90 L KÖŞE	50	ad.	22,22
001 044 020010 00 00	20x10 MM UÇ TAPA	100	ad.	16,67
001 043 020010 00 00	20x10 MM EK PARÇASI	100	ad.	16,67
<b>16X16 KANAL AKSESUARLARI</b>   IP40				
001 039 016016 00 00	16x16 MM İÇ KÖŞE	100	ad.	19,91
001 040 016016 00 00	16x16 MM DIŞ KÖŞE	100	ad.	19,91
001 041 016016 00 00	16x16 MM T KÖŞE	60	ad.	23,84
001 042 016016 00 00	16x16 MM 90 L KÖŞE	60	ad.	23,84
001 044 016016 00 00	16x16 MM UÇ TAPA	100	ad.	17,59
001 043 016016 00 00	16x16 MM EK PARÇASI	100	ad.	17,59
<b>25X16 KANAL AKSESUARLARI</b>   IP40				
001 039 025016 00 00	25x16 MM İÇ KÖŞE	40	ad.	21,30
001 040 025016 00 00	25x16 MM DIŞ KÖŞE	40	ad.	21,30
001 041 025016 00 00	25x16 MM T KÖŞE	30	ad.	32,41
001 042 025016 00 00	25x16 MM 90 L KÖŞE	80	ad.	32,41
001 044 025016 00 00	25x16 MM UÇ TAPA	100	ad.	19,44
001 043 025016 00 00	25x16 MM EK PARÇASI	100	ad.	19,44
001 047 017421 00 00	25X16 MM PMK (45x45)	12	ad.	329,32
<b>25X25 KANAL AKSESUARLARI</b>   IP40				
001 039 025025 00 00	25x25 MM İÇ KÖŞE	40	ad.	23,61
001 040 025025 00 00	25x25 MM DIŞ KÖŞE	40	ad.	23,61
001 041 025025 00 00	25x25 MM T KÖŞE	24	ad.	39,35
001 042 025025 00 00	25x25 MM 90 L KÖŞE	40	ad.	39,35
001 044 025025 00 00	25x25 MM UÇ TAPA	100	ad.	21,99
001 043 025025 00 00	25x25 MM EK PARÇASI	50	ad.	21,99
001 047 017421 00 00	25x25 MM PMK (45x45)	12	ad.	329,32
<b>30X10 KANAL AKSESUARLARI</b>   IP40				
001 039 030010 00 00	30x10 MM İÇ KÖŞE	50	ad.	32,41
001 040 030010 00 00	30x10 MM DIŞ KÖŞE	50	ad.	32,41
001 041 030010 00 00	30x10 MM T KÖŞE	50	ad.	41,67
001 042 030010 00 00	30x10 MM 90 L KÖŞE	50	ad.	41,67
001 044 030025 00 00	30x10-16-25 MM UÇ TAPA	100	ad.	34,72
001 043 030025 00 00	30x10-16-25 MM EK PARÇASI	100	ad.	34,72
<b>30X16 KANAL AKSESUARLARI</b>   IP40				
001 039 030016 00 00	30x16 MM İÇ KÖŞE	35	ad.	55,56
001 040 030016 00 00	30x16 MM DIŞ KÖŞE	48	ad.	55,56
001 041 030016 00 00	30x16 MM T KÖŞE	40	ad.	60,19
001 042 030016 00 00	30x16 MM 90 L KÖŞE	50	ad.	60,19
001 044 030025 00 00	30x10-16-25 MM UÇ TAPA	100	ad.	34,72
001 043 030025 00 00	30x10-16-25 MM EK PARÇASI	100	ad.	34,72
<b>30X25 KANAL AKSESUARLARI</b>   IP40				
001 039 030025 00 00	30x25 MM İÇ KÖŞE	30	ad.	57,87
001 040 030025 00 00	30x25 MM DIŞ KÖŞE	32	ad.	57,87
001 041 030025 00 00	30x25 MM T KÖŞE	24	ad.	60,19
001 042 030025 00 00	30x25 MM 90 L KÖŞE	30	ad.	60,19
001 044 030025 00 00	30x10-16-25 MM UÇ TAPA	100	ad.	34,72
001 043 030025 00 00	30x10-16-25 MM EK PARÇASI	100	ad.	34,72



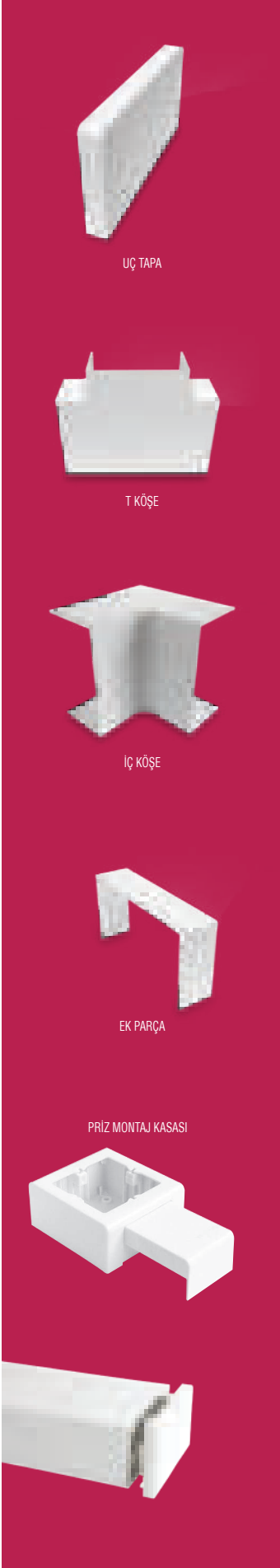

Ürün Kodu	Ürün Adı	Amb. (Kutu)	Amb. Birimi	Fiyat (₺)
<b>40X16 KANAL AKSESUARLARI</b> <span style="float: right;">TS CE IP40</span>				
001 039 040016 00 00	40x16 MM İÇ KÖŞE	32	ad.	43,98
001 040 040016 00 00	40x16 MM DIŞ KÖŞE	30	ad.	43,98
001 041 040016 00 00	40x16 MM T KÖŞE	24	ad.	50,93
001 042 040016 00 00	40x16 MM 90 L KÖŞE	34	ad.	50,93
001 044 040040 00 00	40x16-25-40 MM UÇ TAPA	25	ad.	40,28
001 043 040016 00 00	40x16-25-40 MM EK PARÇASI	100	ad.	40,28
001 047 017421 00 00	40x165 MM PMK (45x45)	12	ad.	329,32
<b>40X25 KANAL AKSESUARLARI</b> <span style="float: right;">TS CE IP40</span>				
001 039 040025 00 00	40x25 MM İÇ KÖŞE	24	ad.	47,69
001 040 040025 00 00	40x25 MM DIŞ KÖŞE	30	ad.	47,69
001 041 040025 00 00	40x25 MM T KÖŞE	18	ad.	53,24
001 042 040025 00 00	40x25 MM 90 L KÖŞE	24	ad.	53,24
001 044 040040 00 00	40x16-25-40 MM UÇ TAPA	25	ad.	40,28
001 043 040016 00 00	40x16-25-40 MM EK PARÇASI	100	ad.	40,28
001 047 017421 00 00	40x25 MM PMK (45x45)	12	ad.	329,32
<b>40X40 KANAL AKSESUARLARI</b> <span style="float: right;">TS CE IP40</span>				
001 039 040040 01 00	40x40 MM İÇ KÖŞE (HAREKETLİ)	18	ad.	48,61
001 040 040040 01 00	40x40 MM DIŞ KÖŞE (HAREKETLİ)	16	ad.	48,61
001 041 040040 00 00	40x40 MM T KÖŞE	48	ad.	55,56
001 042 040040 00 00	40x40 MM 90 L KÖŞE	60	ad.	55,56
001 044 040040 00 00	40x16-25-40 MM UÇ TAPA	50	ad.	40,28
001 043 040016 00 00	40x16-25-40 MM EK PARÇASI	100	ad.	40,28
001 047 017421 00 00	40x40 MM PMK (45x45)	12	ad.	329,32
<b>60X25 KANAL AKSESUARLARI</b> <span style="float: right;">TS CE IP40</span>				
001 039 060025 00 00	60x25 MM İÇ KÖŞE	48	ad.	51,85
001 040 060025 00 00	60x25 MM DIŞ KÖŞE	72	ad.	51,85
001 041 060025 00 00	60x25 MM T KÖŞE	40	ad.	64,81
001 042 060025 00 00	60x25 MM 90 L KÖŞE	60	ad.	64,81
001 044 060025 00 00	60x25 MM UÇ TAPA	50	ad.	38,43
001 043 060025 00 00	60x25 MM EK PARÇASI	60	ad.	38,43
<b>60X40 KANAL AKSESUARLARI</b> <span style="float: right;">TS CE IP40</span>				
001 039 060040 00 00	60x40 MM İÇ KÖŞE	26	ad.	65,28
001 040 060040 00 00	60x40 MM DIŞ KÖŞE	32	ad.	65,28
001 041 060040 00 00	60x40 MM T KÖŞE	32	ad.	68,52
001 042 060040 00 00	60x40 MM 90 L KÖŞE	40	ad.	68,52
001 044 060040 00 00	60x40 MM UÇ TAPA	50	ad.	38,89
001 043 060040 00 00	60x40 MM EK PARÇASI	40	ad.	38,89
<b>60X60 KANAL AKSESUARLARI</b> <span style="float: right;">TS CE IP40</span>				
001 039 060060 01 00	60x60 MM İÇ KÖŞE (HAREKETLİ)	16	ad.	87,96
001 040 060060 01 00	60x60 MM DIŞ KÖŞE (HAREKETLİ)	16	ad.	87,96
001 041 060060 00 00	60x60 MM T KÖŞE	20	ad.	111,11
001 042 060060 00 00	60x60 MM 90 L KÖŞE	24	ad.	111,11
001 044 060060 00 00	60x60 MM UÇ TAPA	30	ad.	60,19
001 043 060060 00 00	60x60 MM EK PARÇASI	25	ad.	60,19
<b>80X40 KANAL AKSESUARLARI</b> <span style="float: right;">TS CE IP40</span>				
001 039 080040 00 00	80x40 MM İÇ KÖŞE	18	ad.	101,85
001 040 080040 00 00	80x40 MM DIŞ KÖŞE	8	ad.	101,85
001 041 080040 00 00	80x40 MM T KÖŞE	12	ad.	115,74
001 042 080040 00 00	80x40 MM 90 L KÖŞE	16	ad.	115,74
001 044 080040 00 00	80x40 MM UÇ TAPA	60	ad.	78,70
001 043 080040 00 00	80x40 MM EK PARÇASI	100	ad.	78,70
<b>80X60 KANAL AKSESUARLARI</b> <span style="float: right;">TS CE IP40</span>				
001 039 080060 00 00	80x60 MM İÇ KÖŞE	12	ad.	106,48
001 040 080060 00 00	80x60 MM DIŞ KÖŞE	8	ad.	106,48
001 041 080060 00 00	80x60 MM T KÖŞE	10	ad.	120,37
001 042 080060 00 00	80x60 MM 90 L KÖŞE	12	ad.	120,37
001 044 080060 00 00	80x60 MM UÇ TAPA	48	ad.	83,33
001 043 080060 00 00	80x60 MM EK PARÇASI	80	ad.	83,33
<b>100X37 KANAL AKSESUARLARI</b> <span style="float: right;">TS CE IP40</span>				
001 039 100037 00 00	100x37 MM İÇ KÖŞE (SABİT)	12	ad.	87,96
001 040 100037 00 00	100x37 MM DIŞ KÖŞE (SABİT)	8	ad.	87,96
001 039 100037 01 00	100x37 MM İÇ KÖŞE (HAREKETLİ)	12	ad.	87,96
001 040 100037 01 00	100x37 MM DIŞ KÖŞE (HAREKETLİ)	10	ad.	87,96
001 041 100037 00 00	100x37 MM T PARÇASI	14	ad.	92,59
001 042 100037 00 00	100x37 MM 90 L KÖŞE	14	ad.	92,59
001 044 100037 00 00	100x37 MM UÇ TAPA	50	ad.	46,30
001 043 100037 00 00	100x37 MM EK PARÇA	100	ad.	46,30
001 050 030003 00 00	100X37/41/50 MM KANAL KİLİTLEME APARATI	75	ad.	17,41
<b>100X40 KANAL AKSESUARLARI</b> <span style="float: right;">TS CE IP40</span>				
001 039 100040 00 00	100x40 MM İÇ KÖŞE (SABİT)	8	ad.	101,85
001 040 100040 00 00	100x40 MM DIŞ KÖŞE (SABİT)	8	ad.	101,85
001 039 100040 01 00	100x40 MM İÇ KÖŞE (HAREKETLİ)	16	ad.	101,85
001 040 100040 01 00	100x40 MM DIŞ KÖŞE (HAREKETLİ)	10	ad.	101,85
001 041 100040 00 00	100x40 MM T PARÇASI	12	ad.	125,00
001 042 100040 00 00	100x40 MM 90 L KÖŞE	12	ad.	125,00
001 044 100060 00 00	100x40 MM UÇ TAPA	20	ad.	50,93
001 043 100060 00 00	100x40 MM EK PARÇA	100	ad.	50,93
001 050 030004 00 00	100x40 MM KANAL KİLİTLEME APARATI	100	ad.	17,41
001 013 100040 20 00	100x40 MM ARA BÖLME	200	mt.	69,44



## KANAL İÇİN UPS VE ENERJİ PRİZLERİ (45x45)



ÜRÜN KODU	001 052 300001 00 00
ÜRÜN ADI	45x45 TOP.P. ÇEKİRDEĞİ Ç.K. (45°)
AMB. AD./KOLİ	50/300
FİYAT (₺)	129,63



ÜRÜN KODU	001 052 300002 00 00
ÜRÜN ADI	45x45 UPS.P. ÇEKİRDEĞİ Ç.K. (45°)
AMB. AD./KOLİ	50/300
FİYAT (₺)	133,33

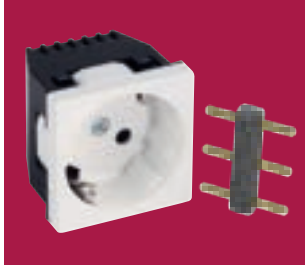

ÜRÜN KODU	001 052 200003 00 00
ÜRÜN ADI	45x45 PRİZ BİRLEŞTİRME APARATI (YANDAN) (YENİ)
AMB. AD./KOLİ	500/5000
FİYAT (₺)	37,04



ÜRÜN KODU	001 052 200005 00 00
ÜRÜN ADI	45x45 PRİZ BİRLEŞTİRME APARATI
AMB. AD./KOLİ	50/500
FİYAT (₺)	66,67



ÜRÜN KODU	888 049 050040
ÜRÜN ADI	45x22,5 ANAHTAR
AMB. AD./KOLİ	20/400
FİYAT	3,36 \$



ÜRÜN KODU	888 049 050043
ÜRÜN ADI	45x22,5 VAVİEN
AMB. AD./KOLİ	20/400
FİYAT	3,90 \$

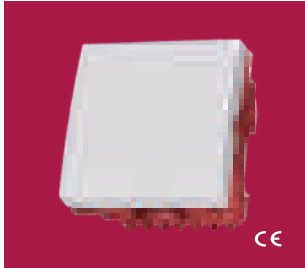

ÜRÜN KODU	888 049 050063
ÜRÜN ADI	45x45 ANAHTAR
AMB. AD./KOLİ	10/200
FİYAT	4,81 \$

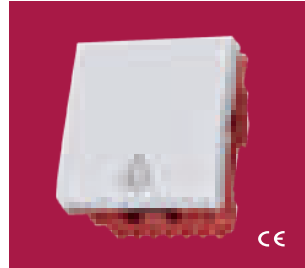

ÜRÜN KODU	888 049 050044
ÜRÜN ADI	45x45 YAYLI ÇAĞIRMA (LIGHT)
AMB. AD./KOLİ	10/200
FİYAT	4,81 \$

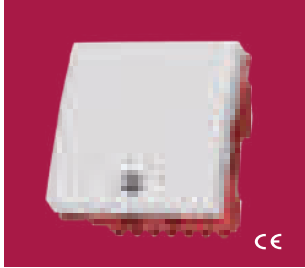

ÜRÜN KODU	888 049 050064
ÜRÜN ADI	45x45 ARA VAVİEN
AMB. AD./KOLİ	10/200
FİYAT	6,60 \$

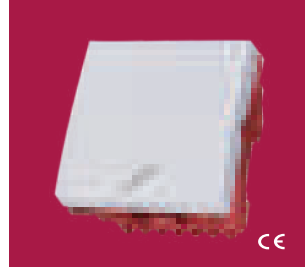

ÜRÜN KODU	888 049 050065
ÜRÜN ADI	45x45 VAVİEN
AMB. AD./KOLİ	10/200
FİYAT	5,10 \$

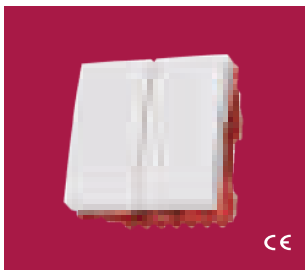

ÜRÜN KODU	888 049 050042
ÜRÜN ADI	45x45 KOMİTATÖR
AMB. AD./KOLİ	10/200
FİYAT	5,90 \$



ÜRÜN KODU	888 049 050041
ÜRÜN ADI	45x45 ÇOK AMAÇLI PRİZ
AMB. AD./KOLİ	10/200
FİYAT	5,90 \$

## KANAL İÇİN UPS VE ENERJİ PRİZLERİ (45x45)



ÜRÜN KODU	888 049 050058
ÜRÜN ADI	45x22,5 USB 2.0 - AF/AF DATA 90 GİRİŞ
AMB. AD./KOLİ	50/500
FİYAT	3,08 \$

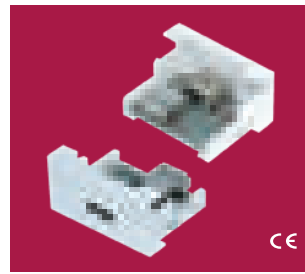

ÜRÜN KODU	888 049 050059
ÜRÜN ADI	45x22,5 USB 2.0 - AF/AF DATA 180 GİRİŞ
AMB. AD./KOLİ	50/500
FİYAT	3,08 \$

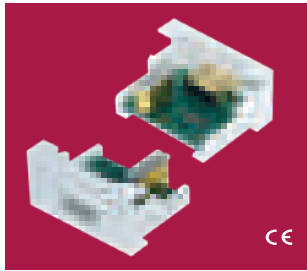

ÜRÜN KODU	888 049 050046
ÜRÜN ADI	45x22,5 HDMI 90 GİRİŞ
AMB. AD./KOLİ	50/500
FİYAT	8,76 \$

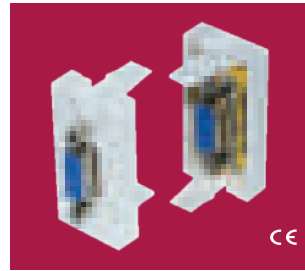

ÜRÜN KODU	888 049 050047
ÜRÜN ADI	45x22,5 VGA DATA JACK
AMB. AD./KOLİ	50/500
FİYAT	4,98 \$



ÜRÜN KODU	888 049 050056
ÜRÜN ADI	45x22,5 TV PRİZİ ERKEK
AMB. AD./KOLİ	50/500
FİYAT	2,23 \$



ÜRÜN KODU	888 049 050057
ÜRÜN ADI	45x22,5 TV PRİZİ DIŞI
AMB. AD./KOLİ	50/500
FİYAT	2,33 \$



ÜRÜN KODU	888 049 050049
ÜRÜN ADI	45x22,5 RCA
AMB. AD./KOLİ	50/500
FİYAT	5,49 \$



ÜRÜN KODU	888 049 050060
ÜRÜN ADI	45x22,5 SES JAKI 3,5 mm STEREO
AMB. AD./KOLİ	50/500
FİYAT	3,02 \$



ÜRÜN KODU	888 049 050051
ÜRÜN ADI	45x22,5 KÖR KAPAK
AMB. AD./KOLİ	100/1000
FİYAT	0,35 \$



ÜRÜN KODU	888 049 050012
ÜRÜN ADI	45x22,5 KEYSTONE JACK PANJURLU KAPAK
AMB. AD./KOLİ	100/1000
FİYAT	0,47 \$



ÜRÜN KODU	888 049 050055
ÜRÜN ADI	45x45 KÖR KAPAK
AMB. AD./KOLİ	100/400
FİYAT	0,36 \$

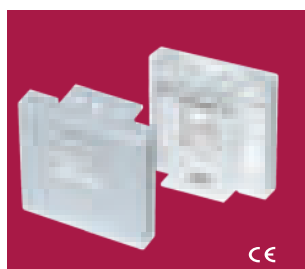

ÜRÜN KODU	888 049 050013
ÜRÜN ADI	45x45 KEYSTONE JACK PANJURLU KAPAK
AMB. AD./KOLİ	100/500
FİYAT	0,65 \$

## KANAL İÇİN UPS VE ENERJİ PRİZLERİ (45x45)



ÜRÜN KODU	888 049 050061
ÜRÜN ADI	45x22,5 USB ŞARJ PRİZİ 5V 2,1A
AMB. AD./KOLİ	10/200
FİYAT	22,04 \$

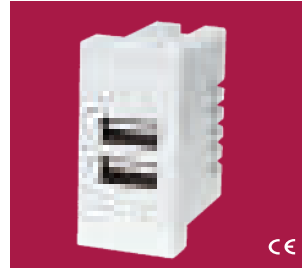

ÜRÜN KODU	888 049 050062
ÜRÜN ADI	45x22,5 U2'Lİ USB ŞARJ PRİZİ 5V 2,1A
AMB. AD./KOLİ	20/200
FİYAT	24,89 \$



ÜRÜN KODU	888 049 050074
ÜRÜN ADI	45x45 ŞARJ PRİZİ TYPE-C+ TYPE-C (C+C) 5V 4.2A
AMB. AD./KOLİ	10/200
FİYAT	28,30 \$



ÜRÜN KODU	888 049 050075
ÜRÜN ADI	45x45 ŞARJ PRİZİ TYPE-C (C) 5V 3A
AMB. AD./KOLİ	10/200
FİYAT	21,43 \$



ÜRÜN KODU	888 049 050076
ÜRÜN ADI	45x45 ŞARJ PRİZİ USB+TYPE-C (A+C) 5V 4.2A
AMB. AD./KOLİ	10/200
FİYAT	27,54 \$



ÜRÜN KODU	888 049 050008
ÜRÜN ADI	DATA KONNEKTÖRÜ CAT 5e (RJ45)
AMB. AD./KOLİ	100/1000
FİYAT	1,23 \$

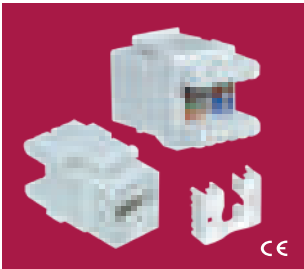

ÜRÜN KODU	888 049 050032
ÜRÜN ADI	DATA KONNEKTÖRÜ CAT 6e (RJ65 8)
AMB. AD./KOLİ	100/1000
FİYAT	1,25 \$

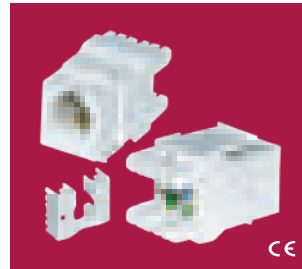

ÜRÜN KODU	888 049 050009
ÜRÜN ADI	TELEFON KONNEKTÖRÜ (RJ 11/12 6)
AMB. AD./KOLİ	100/1000
FİYAT	1,23 \$

## RACK KABİN PRİZ ve AKSESUARLARI



ÜRÜN KODU	075 171 222508
ÜRÜN ADI	16 MODÜL DÖŞEME ALTI PRİZ SİSTEMİ(BOŞ) 270x270
AMB. AD./KOLİ	1/10
FİYAT (₺)	2.037,04

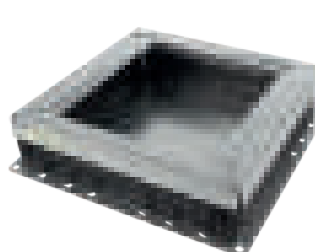

ÜRÜN KODU	075 171 333308
ÜRÜN ADI	16 MODÜL DÖŞEME ALTI PRİZ SİSTEMİ BUATI 352x352
AMB. AD./KOLİ	1/5
FİYAT (₺)	2.007,41

Ürün Kodu	Ürün Adı	Amb. (Kutu)	Amb. Birimi	Fiyat (₺)
<b>SİDEM SERİSİ RENKLİ KABLO KANALLARI</b>				
001 007 010008 20 XX	10X8 MM KABLO KANALI (SİDEM)	330	mt.	66,67
001 007 012012 20 XX	12X12 MM KABLO KANALI (SİDEM)	250	mt.	66,67
001 007 015010 20 XX	15X10 MM KABLO KANALI (SİDEM)	250	mt.	66,67
001 007 016016 20 XX	16X16 MM KABLO KANALI (SİDEM)	250	mt.	83,33
001 007 020010 20 XX	20X10 MM KABLO KANALI (SİDEM)	200	mt.	66,67
001 007 025016 20 XX	25X16 MM KABLO KANALI (SİDEM)	150	mt.	103,70
001 007 025025 20 XX	25X25 MM KABLO KANALI (SİDEM)	100	mt.	129,63
001 007 930010 20 XX	30X10 MM KABLO KANALI (SİDEM) BÖLMELİ	140	mt.	111,11
001 007 930016 20 XX	30X16 MM KABLO KANALI (SİDEM) BÖLMELİ	140	mt.	148,15
001 007 030025 20 XX	30X25 MM KABLO KANALI (SİDEM)	80	mt.	166,67
001 007 040016 20 XX	40X16 MM KABLO KANALI (SİDEM)	100	mt.	148,15
001 007 940016 20 XX	40X16 MM KABLO KANALI (SİDEM)(BÖLMELİ)	100	mt.	166,67
001 007 040025 20 XX	40X25 MM KABLO KANALI (SİDEM)	80	mt.	185,19
001 007 040040 20 XX	40X40 MM KABLO KANALI (SİDEM)	50	mt.	203,70
001 007 960025 20 XX	60X25 MM KABLO KANALI (SİDEM) BÖLMELİ	40	mt.	296,30
001 007 060040 20 XX	60X40 MM KABLO KANALI (SİDEM)	40	mt.	277,78
001 007 060060 20 XX	60X60 MM KABLO KANALI (SİDEM)	32	mt.	444,44
001 007 080040 20 XX	80X40 MM KABLO KANALI (SİDEM)	30	mt.	444,44
001 007 080060 20 XX	80X60 MM KABLO KANALI (SİDEM)	24	mt.	481,48
001 007 100040 20 XX	100X40 MM KABLO KANALI (SİDEM)	24	mt.	518,52
001 007 100048 20 XX	100X48 MM KABLO KANALI (SİDEM)	24	mt.	518,52
001 007 100060 20 XX	100X60 MM KABLO KANALI (SİDEM)	20	mt.	703,70
001 007 075060 20 XX	75X60 MM KABLO KANALI (SİDEM)	30	mt.	481,48
001 007 100037 20 XX	100X37 MM KABLO KANALI (SİDEM) İ.KAPAKLI	30	mt.	555,56
001 007 100050 20 XX	100X50 MM KABLO KANALI (SİDEM) İ.KAPAKLI	20	mt.	592,59
001 007 120060 20 XX	120X60 MM KABLO KANALI (SİDEM) İ.KAPAKLI	16	mt.	777,78
001 007 120070 20 XX	120X70 MM KABLO KANALI (SİDEM)	16	mt.	1.000,00
001 007 170070 20 XX	170X70 MM KABLO KANALI (SİDEM)	12	mt.	1.259,26
<b>SİDEM SERİSİ RENKLİ KABLO KANALLARI (YAPIŞKANLI)</b>				
001 155 010008 20 XX	10X8 MM KABLO KANALI (SİDEM) YAPIŞKANLI	330	mt.	86,67
001 155 012012 20 XX	12X12 MM KABLO KANALI (SİDEM) YAPIŞKANLI	250	mt.	86,67
001 155 015010 20 XX	15X10 MM KABLO KANALI (SİDEM) YAPIŞKANLI	250	mt.	86,67
001 155 016016 20 XX	16X16 MM KABLO KANALI (SİDEM) YAPIŞKANLI	240	mt.	108,33
001 155 020010 20 XX	20X10 MM KABLO KANALI (SİDEM) YAPIŞKANLI	180	mt.	86,67
001 155 025016 20 XX	25X16 MM KABLO KANALI (SİDEM) YAPIŞKANLI	150	mt.	134,81
001 155 025025 20 XX	25X25 MM KABLO KANALI (SİDEM) YAPIŞKANLI	100	mt.	168,52
001 155 930010 20 XX	30X10 MM KABLO KANALI (SİDEM) YAPIŞKANLI	140	mt.	122,22
001 155 930016 20 XX	30X16 MM KABLO KANALI (SİDEM) YAPIŞKANLI	140	mt.	155,56
001 155 030025 20 XX	30X25 MM KABLO KANALI (SİDEM) YAPIŞKANLI	80	mt.	216,67
001 155 040016 20 XX	40X16 MM KABLO KANALI (SİDEM) YAPIŞKANLI	100	mt.	207,41
001 155 040025 20 XX	40X25 MM KABLO KANALI (SİDEM) YAPIŞKANLI	80	mt.	240,74
001 155 040040 20 XX	40X40 MM KABLO KANALI (SİDEM) YAPIŞKANLI	50	mt.	264,81
001 155 960025 20 XX	60X25 MM KABLO KANALI (SİDEM) YAPIŞKANLI	40	mt.	385,19
001 155 060040 20 XX	60X40 MM KABLO KANALI (SİDEM) YAPIŞKANLI	40	mt.	361,11
<b>SİDEM SERİSİ SÜPÜRGELİKLER ve AKSESUARLARI</b>				
001 007 974020 20 XX	74X20 MM KABLO KANALI (SİDEM) BÖLMELİ	50	mt.	296,30
001 007 975022 20 XX	75X22 MM KABLO KANALI (SİDEM) BÖLMELİ	50	mt.	444,44
<b>SİDEM SERİSİ BALIK SIRTİ ZEMİN KANALLARI ve AKSESUARLARI</b>				
001 007 050013 20 XX	50X13 MM KABLO KANALI (SİDEM)	60	mt.	221,20
001 007 060015 20 XX	60X15 MM KABLO KANALI (SİDEM)	40	mt.	245,00
001 031 060015 00 XX	60X15 MM L KÖŞE(SİDEM)	1	ad.	110,00
001 032 060015 00 XX	60X15 MM EK PARÇA (SİDEM)	1	ad.	67,50
001 033 060015 00 XX	60X15 MM SONLAMA KAPAĞI (SİDEM)	1	ad.	38,75
001 030 060015 00 XX	60X15 MM T KÖŞE (SİDEM)	1	ad.	125,25
001 007 075018 20 XX	75X18 MM KABLO KANALI (SİDEM)	30	mt.	353,75
001 007 090020 20 XX	90X20 MM KABLO KANALI (SİDEM)	20	mt.	530,00
<b>SİDEM SERİSİ BALIK SIRTİ ZEMİN KANALLARI (YAPIŞKANLI)</b>				
001 155 050013 20 XX	50X13 MM KABLO KANALI (SİDEM) YAPIŞKANLI	60	mt.	351,85
001 155 060015 20 XX	60X15 MM KABLO KANALI (SİDEM) YAPIŞKANLI	40	mt.	370,37
001 155 075018 20 XX	75X18 MM KABLO KANALI (SİDEM) YAPIŞKANLI	30	mt.	407,41
<b>12x12 KANAL AKSESUARLARI - SİDEM SERİSİ</b>				
001 028 012012 00 XX	12X12 MM (SİDEM) İÇ KÖŞE	1	ad.	51,73
001 029 012012 00 XX	12X12 MM (SİDEM) DIŞ KÖŞE	1	ad.	51,73
001 030 012012 00 XX	12X12 MM (SİDEM) T KÖŞE	1	ad.	51,08
001 031 012012 00 XX	12X12 MM (SİDEM) 90 L KÖŞE	1	ad.	51,08
001 033 012012 00 XX	12X12 MM (SİDEM) UÇ TAPA	1	ad.	36,26
001 032 012012 00 XX	12X12 MM (SİDEM) EK PARÇASI	1	ad.	36,26
<b>15x10 KANAL AKSESUARLARI - SİDEM SERİSİ</b>				
001 028 015010 00 XX	15X10 MM (SİDEM) İÇ KÖŞE	1	ad.	33,38
001 029 015010 00 XX	15X10 MM (SİDEM) DIŞ KÖŞE	1	ad.	33,38
001 030 015010 00 XX	15X10 MM (SİDEM) T KÖŞE	1	ad.	52,65
001 031 015010 00 XX	15X10 MM (SİDEM) 90 L KÖŞE	1	ad.	52,65
001 033 015010 00 XX	15X10 MM (SİDEM) UÇ TAPA	1	ad.	30,82
001 032 015010 00 XX	15X10 MM (SİDEM) EK PARÇASI	1	ad.	30,82



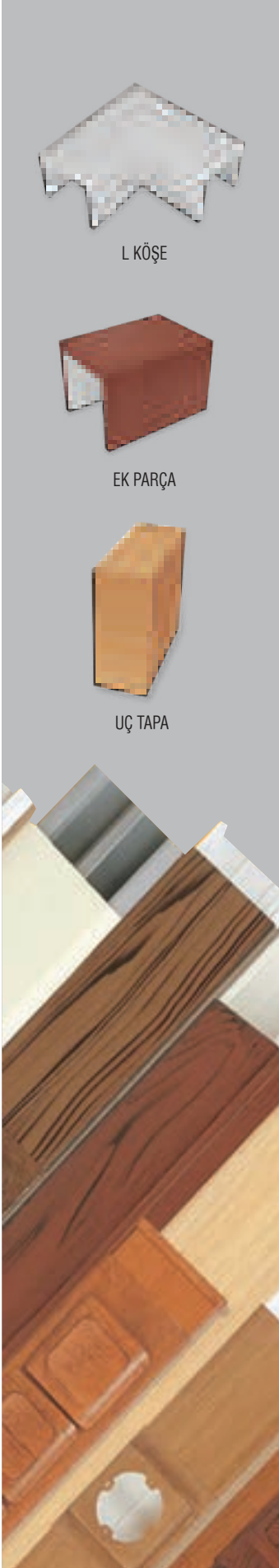

Ürün Kodu	Ürün Adı	Amb. (Kutu)	Amb. Birimi	Fiyat (₺)
<b>16x16 KANAL AKSESUARLARI - SİDEM SERİSİ</b>				<b>CE</b>
001 028 016016 00 XX	16x16 MM (SİDEM) İÇ KÖŞE	1	ad.	32,02
001 029 016016 00 XX	16x16 MM (SİDEM) DIŞ KÖŞE	1	ad.	32,02
001 030 016016 00 XX	16x16 MM (SİDEM) T KÖŞE	1	ad.	60,72
001 031 016016 00 XX	16x16 MM (SİDEM) 90 L KÖŞE	1	ad.	60,72
001 033 016016 00 XX	16x16 MM (SİDEM) UÇ TAPA	1	ad.	30,21
001 032 016016 00 XX	16x16 MM (SİDEM) EK PARÇASI	1	ad.	30,21
<b>20x10 KANAL AKSESUARLARI - SİDEM SERİSİ</b>				<b>CE</b>
001 028 020010 00 XX	20x10 MM (SİDEM) İÇ KÖŞE	1	ad.	47,82
001 029 020010 00 XX	20x10 MM (SİDEM) DIŞ KÖŞE	1	ad.	47,82
001 030 020010 00 XX	20x10 MM (SİDEM) T KÖŞE	1	ad.	50,01
001 031 020010 00 XX	20x10 MM (SİDEM) 90 L KÖŞE	1	ad.	50,01
001 033 020010 00 XX	20x10 MM (SİDEM) UÇ TAPA	1	ad.	33,90
001 032 020010 00 XX	20x10 MM (SİDEM) EK PARÇASI	1	ad.	33,90
<b>TAVAN KÖŞE KANALI (23x23) AKSESUARLARI -SİDEM SERİSİ</b>				<b>CE</b>
001 041 023023 00 XX	23X23 MM T PARÇASI	1	ad.	140,65
001 042 023023 00 XX	23X23 MM 90 L KÖŞE	1	ad.	140,65
001 043 023023 00 XX	23X23 MM EK PARÇA	1	ad.	36,57
001 044 023023 00 XX	23X23 MM UÇ TAPA	1	ad.	36,57
<b>25x16 KANAL AKSESUARLARI - SİDEM SERİSİ</b>				<b>CE</b>
001 028 025016 00 XX	25X16 MM (SİDEM) İÇ KÖŞE	1	ad.	63,80
001 029 025016 00 XX	25X16 MM (SİDEM) DIŞ KÖŞE	1	ad.	63,80
001 030 025016 00 XX	25X16 MM (SİDEM) T KÖŞE	1	ad.	71,67
001 031 025016 00 XX	25X16 MM (SİDEM) 90 L KÖŞE	1	ad.	71,67
001 033 025016 00 XX	25X16 MM (SİDEM) UÇ TAPA	1	ad.	41,84
001 032 025016 00 XX	25X16 MM (SİDEM) EK PARÇA	1	ad.	41,84
001 034 017421 00 XX	25X16 MM (SİDEM) PMK (45X45)	1	ad.	641,23
<b>25x25 KANAL AKSESUARLARI - SİDEM SERİSİ</b>				<b>CE</b>
001 028 025025 00 XX	25x25 MM (SİDEM) İÇ KÖŞE	1	ad.	48,01
001 029 025025 00 XX	25x25 MM (SİDEM) DIŞ KÖŞE	1	ad.	48,01
001 030 025025 00 XX	25x25 MM (SİDEM) T PARÇASI	1	ad.	67,26
001 031 025025 00 XX	25x25 MM (SİDEM) 90 L KÖŞE	1	ad.	67,26
001 033 025025 00 XX	25x25 MM (SİDEM) UÇ TAPA	1	ad.	34,81
001 032 025025 00 XX	25x25 MM (SİDEM) EK PARÇA	1	ad.	34,81
001 034 017421 00 XX	25x25 MM (SİDEM) PMK (45X45)	1	ad.	641,23
<b>30x10 KANAL AKSESUARLARI - SİDEM SERİSİ</b>				<b>CE</b>
001 028 030010 00 XX	30X10 MM (SİDEM) İÇ KÖŞE	1	ad.	75,52
001 029 030010 00 XX	30X10 MM (SİDEM) DIŞ KÖŞE	1	ad.	75,52
001 030 030010 00 XX	30X10 MM (SİDEM) T PARÇASI	1	ad.	80,83
001 031 030010 00 XX	30X10 MM (SİDEM) 90 L KÖŞE	1	ad.	80,83
001 033 030010 00 XX	30X10 MM (SİDEM) UÇ TAPA	1	ad.	37,52
001 032 030010 00 XX	30X10 MM (SİDEM) EK PARÇA	1	ad.	37,52
<b>30x16 KANAL AKSESUARLARI - SİDEM SERİSİ</b>				<b>CE</b>
001 028 030016 00 XX	30x16 MM (SİDEM) İÇ KÖŞE	1	ad.	77,15
001 029 030016 00 XX	30x16 MM (SİDEM) DIŞ KÖŞE	1	ad.	77,15
001 030 030016 00 XX	30x16 MM (SİDEM) T PARÇASI	1	ad.	103,80
001 031 030016 00 XX	30x16 MM (SİDEM) 90 L KÖŞE	1	ad.	103,80
001 033 030016 00 XX	30x16 MM (SİDEM) UÇ TAPA	1	ad.	43,67
001 032 030016 00 XX	30x16 MM (SİDEM) EK PARÇA	1	ad.	43,67
<b>30x25 KANAL AKSESUARLARI - SİDEM SERİSİ</b>				<b>CE</b>
001 028 030025 00 XX	30X25 MM (SİDEM) İÇ KÖŞE	1	ad.	81,72
001 029 030025 00 XX	30X25 MM (SİDEM) DIŞ KÖŞE	1	ad.	81,72
001 030 030025 00 XX	30X25 MM (SİDEM) T PARÇASI	1	ad.	105,07
001 031 030025 00 XX	30X25 MM (SİDEM) 90 L KÖŞE	1	ad.	105,07
001 033 030025 00 XX	30X25 MM (SİDEM) UÇ TAPA	1	ad.	45,83
001 032 030025 00 XX	30X25 MM (SİDEM) EK PARÇA	1	ad.	45,83
<b>40x16 KANAL AKSESUARLARI - SİDEM SERİSİ</b>				<b>CE</b>
001 028 040016 00 XX	40x16 MM (SİDEM) İÇ KÖŞE	1	ad.	83,08
001 029 040016 00 XX	40x16 MM (SİDEM) DIŞ KÖŞE	1	ad.	83,08
001 030 040016 00 XX	40x16 MM (SİDEM) T PARÇASI	1	ad.	110,76
001 031 040016 00 XX	40x16 MM (SİDEM) 90 L KÖŞE	1	ad.	110,76
001 033 040016 00 XX	40x16 MM (SİDEM) UÇ TAPA	1	ad.	55,95
001 032 040016 00 XX	40x16 MM (SİDEM) EK PARÇA	1	ad.	55,96
001 034 017421 00 XX	40X16 MM (SİDEM) PMK (45X45)	1	ad.	670,37
<b>40x25 KANAL AKSESUARLARI - SİDEM SERİSİ</b>				<b>CE</b>
001 028 040025 00 XX	40X25 MM (SİDEM) İÇ KÖŞE	1	ad.	96,23
001 029 040025 00 XX	40X25 MM (SİDEM) DIŞ KÖŞE	1	ad.	96,23
001 030 040025 00 XX	40X25 MM (SİDEM) T KÖŞE	1	ad.	120,19
001 031 040025 00 XX	40X25 MM (SİDEM) 90 L KÖŞE	1	ad.	120,19
001 033 040025 00 XX	40X25 MM (SİDEM) UÇ TAPA	1	ad.	64,26
001 032 040025 00 XX	40X25 MM (SİDEM) EK PARÇASI	1	ad.	64,26
001 034 017421 00 XX	40X25 MM (SİDEM) PMK (45X45)	1	ad.	699,52

Ürün Kodu	Ürün Adı	Amb. (Kutu)	Amb. Birimi	Fiyat (₺)
<b>40x40 KANAL AKSESUARLARI - SİDEM SERİSİ</b>				<b>€€</b>
001 028 040040 00 XX	40x40 MM (SİDEM) İÇ KÖŞE	1	ad.	101,70
001 029 040040 00 XX	40x40 MM (SİDEM) DIŞ KÖŞE	1	ad.	101,70
001 030 040040 00 XX	40x40 MM (SİDEM) T KÖŞE	1	ad.	106,71
001 031 040040 00 XX	40x40 MM (SİDEM) 90 L KÖŞE	1	ad.	106,70
001 033 040040 00 XX	40x40 MM (SİDEM) UÇ TAPA	1	ad.	77,46
001 032 040040 00 XX	40x40 MM (SİDEM) EK PARÇASI	1	ad.	77,46
001 034 017421 00 XX	40x40 MM (SİDEM) PMK (45X45)	1	ad.	699,52
<b>60x25 KANAL AKSESUARLARI - SİDEM SERİSİ</b>				<b>€€</b>
001 028 060025 00 XX	60x25 MM (SİDEM) İÇ KÖŞE	1	ad.	107,00
001 029 060025 00 XX	60x25 MM (SİDEM) DIŞ KÖŞE	1	ad.	107,00
001 030 060025 00 XX	60x25 MM (SİDEM) T KÖŞE	1	ad.	115,23
001 031 060025 00 XX	60x25 MM (SİDEM) 90 L KÖŞE	1	ad.	115,23
001 033 060025 00 XX	60x25 MM (SİDEM) UÇ TAPA	1	ad.	77,92
001 032 060025 00 XX	60x25 MM (SİDEM) EK PARÇASI	1	ad.	77,92
<b>60x40 KANAL AKSESUARLARI - SİDEM SERİSİ</b>				<b>€€</b>
001 028 060040 00 XX	60x40 MM (SİDEM) İÇ KÖŞE	1	ad.	108,31
001 029 060040 00 XX	60x40 MM (SİDEM) DIŞ KÖŞE	1	ad.	108,31
001 030 060040 00 XX	60x40 MM (SİDEM) T KÖŞE	1	ad.	113,59
001 031 060040 00 XX	60x40 MM (SİDEM) 90 L KÖŞE	1	ad.	113,59
001 033 060040 00 XX	60x40 MM (SİDEM) UÇ TAPA	1	ad.	79,05
001 032 060040 00 XX	60x40 MM (SİDEM) EK PARÇA	1	ad.	79,05
<b>60x60 KANAL AKSESUARLARI - SİDEM SERİSİ</b>				<b>€€</b>
001 028 060060 00 XX	60x60 MM (SİDEM) İÇ KÖŞE	1	ad.	134,59
001 029 060060 00 XX	60x60 MM (SİDEM) DIŞ KÖŞE	1	ad.	134,59
001 030 060060 00 XX	60x60 MM (SİDEM) T PARÇASI	1	ad.	154,93
001 031 060060 00 XX	60x60 MM (SİDEM) 90 L KÖŞE	1	ad.	154,93
001 033 060060 00 XX	60x60 MM (SİDEM) UÇ TAPA	1	ad.	92,33
001 032 060060 00 XX	60x60 MM (SİDEM) EK PARÇA	1	ad.	92,33
<b>74x20 KANAL AKSESUARLARI - SİDEM SERİSİ</b>				<b>€€</b>
001 028 074020 00 XX	74x20 MM (SİDEM) İÇ KÖŞE	1	ad.	112,13
001 029 074020 00 XX	74x20 MM (SİDEM) DIŞ KÖŞE	1	ad.	112,13
001 030 074020 00 XX	74x20 MM (SİDEM) T PARÇASI	1	ad.	116,95
001 031 074020 00 XX	74x20 MM (SİDEM) 90 L KÖŞE	1	ad.	116,95
001 032 074020 00 XX	74x20 MM (SİDEM) UÇ TAPA	1	ad.	106,19
001 033 074020 00 XX	74x20 MM (SİDEM) EK PARÇA	1	ad.	106,19
001 036 017420 00 XX	74x20 MM (SİDEM) PRİZ MONTAJ KASASI	1	ad.	1.148,24
<b>75x22 KANAL AKSESUARLARI - SİDEM SERİSİ</b>				<b>€€</b>
001 028 075022 00 XX	75x22 MM (SİDEM) İÇ KÖŞE	1	ad.	103,35
001 029 075022 00 XX	75x22 MM (SİDEM) DIŞ KÖŞE	1	ad.	103,35
001 033 075022 01 XX	75x22 MM (SİDEM) SAĞ SONLAMA	1	ad.	141,59
001 033 075022 02 XX	75x22 MM (SİDEM) SOL SONLAMA	1	ad.	141,59
001 032 075022 00 XX	75x22 MM (SİDEM) EK PARÇASI	1	ad.	93,77
<b>80x40 KANAL AKSESUARLARI - SİDEM SERİSİ</b>				<b>€€</b>
001 028 080040 00 XX	80x40 MM (SİDEM) İÇ KÖŞE	1	ad.	142,95
001 029 080040 00 XX	80x40 MM (SİDEM) DIŞ KÖŞE	1	ad.	142,95
001 030 080040 00 XX	80x40 MM (SİDEM) T PARÇASI	1	ad.	156,34
001 031 080040 00 XX	80x40 MM (SİDEM) 90 L KÖŞE	1	ad.	156,34
001 033 080040 00 XX	80x40 MM (SİDEM) UÇ TAPA	1	ad.	121,84
001 032 080040 00 XX	80x40 MM (SİDEM) EK PARÇA	1	ad.	121,84
<b>80x60 KANAL AKSESUARLARI - SİDEM SERİSİ</b>				<b>€€</b>
001 028 080060 00 XX	80x60 MM (SİDEM) İÇ KÖŞE	1	ad.	186,16
001 029 080060 00 XX	80x60 MM (SİDEM) DIŞ KÖŞE	1	ad.	186,16
001 030 080060 00 XX	80x60 MM (SİDEM) T PARÇASI	1	ad.	162,84
001 031 080060 00 XX	80x60 MM (SİDEM) 90 L KÖŞE	1	ad.	162,84
001 033 080060 00 XX	80x60 MM (SİDEM) UÇ TAPA	1	ad.	116,97
001 032 080060 00 XX	80x60 MM (SİDEM) EK PARÇA	1	ad.	116,97



İÇ KÖŞE



DIŞ KÖŞE



T KÖŞE



L KÖŞE



EK PARÇA



UÇ TAPA

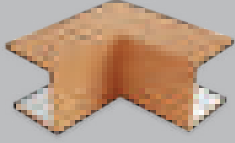

İÇ KÖŞE



DIŞ KÖŞE



T KÖŞE



L KÖŞE



Ürün Kodu	Ürün Adı	Amb. (Kutu)	Amb. Birimi	Fiyat (₺)
<b>100x37 KANAL AKSESUARLARI - SİDEM SERİSİ</b>				<b>CE</b>
001 028 100037 00 XX	100X37 MM (SİDEM) İÇ KÖŞE (SABİT)	1	ad.	229,65
001 029 100037 00 XX	100X37 MM (SİDEM) DIŞ KÖŞE (SABİT)	1	ad.	229,65
001 028 100037 01 XX	100X37 MM (SİDEM) İÇ KÖŞE (HAREKETLİ)	1	ad.	229,65
001 029 100037 01 XX	100X37 MM (SİDEM) DIŞ KÖŞE (HAREKETLİ)	1	ad.	229,65
001 030 100037 00 XX	100X37 MM (SİDEM) T PARÇASI	1	ad.	244,67
001 031 100037 00 XX	100X37 MM (SİDEM) 90 L KÖŞE	1	ad.	244,67
001 033 100037 00 XX	100X37 MM (SİDEM) UÇ TAPA	1	ad.	160,26
001 032 100037 00 XX	100X37 MM (SİDEM) EK PARÇA	1	ad.	160,26
<b>100x40 KANAL AKSESUARLARI - SİDEM SERİSİ</b>				<b>CE</b>
001 028 100040 00 XX	100X40 MM (SİDEM) İÇ KÖŞE (SABİT)	1	ad.	239,46
001 029 100040 00 XX	100X40 MM (SİDEM) DIŞ KÖŞE (SABİT)	1	ad.	239,46
001 028 100040 01 XX	100X40 MM (SİDEM) İÇ KÖŞE (HAREKETLİ)	1	ad.	239,46
001 029 100040 01 XX	100X40 MM (SİDEM) DIŞ KÖŞE (HAREKETLİ)	1	ad.	239,46
001 030 100040 00 XX	100X40 MM (SİDEM) T PARÇASI	1	ad.	248,98
001 031 100040 00 XX	100X40 MM (SİDEM) 90 L KÖŞE	1	ad.	248,98
001 033 100040 00 XX	100X40 MM (SİDEM) UÇ TAPA	1	ad.	162,89
001 032 100040 00 XX	100X40 MM (SİDEM) EK PARÇA	1	ad.	162,89
<b>100x48 KANAL AKSESUARLARI - SİDEM SERİSİ</b>				<b>CE</b>
001 028 100048 00 XX	100X48 MM (SİDEM) İÇ KÖŞE (SABİT)	1	ad.	258,64
001 029 100048 00 XX	100X48 MM (SİDEM) DIŞ KÖŞE (SABİT)	1	ad.	258,64
001 028 100048 01 XX	100X48 MM (SİDEM) İÇ KÖŞE (HAREKETLİ)	1	ad.	258,64
001 029 100048 01 XX	100X48 MM (SİDEM) DIŞ KÖŞE (HAREKETLİ)	1	ad.	258,64
001 030 100048 00 XX	100X48 MM (SİDEM) T PARÇASI	1	ad.	267,57
001 031 100048 00 XX	100X48 MM (SİDEM) 90 L KÖŞE	1	ad.	267,57
001 033 100048 00 XX	100X48 MM (SİDEM) UÇ TAPA	1	ad.	173,13
001 032 100048 00 XX	100X48 MM (SİDEM) EK PARÇA	1	ad.	173,13
<b>100x50 KANAL AKSESUARLARI - SİDEM SERİSİ</b>				<b>CE</b>
001 028 100050 00 XX	100X50 MM (SİDEM) İÇ KÖŞE (SABİT)	1	ad.	226,89
001 029 100050 00 XX	100X50 MM (SİDEM) DIŞ KÖŞE (SABİT)	1	ad.	226,89
001 028 100050 01 XX	100X50 MM (SİDEM) İÇ KÖŞE (HAREKETLİ)	1	ad.	226,89
001 029 100050 01 XX	100X50 MM (SİDEM) DIŞ KÖŞE (HAREKETLİ)	1	ad.	226,89
001 030 100050 00 XX	100X50 MM (SİDEM) T PARÇASI	1	ad.	232,00
001 031 100050 00 XX	100X50 MM (SİDEM) 90 L KÖŞE	1	ad.	232,00
001 033 100050 00 XX	100X50 MM (SİDEM) UÇ TAPA	1	ad.	150,75
001 032 100050 00 XX	100X50 MM (SİDEM) EK PARÇA	1	ad.	150,75
<b>100x60 KANAL AKSESUARLARI - SİDEM SERİSİ</b>				<b>CE</b>
001 028 100060 00 XX	100X60 MM (SİDEM) İÇ KÖŞE (SABİT)	1	ad.	256,16
001 029 100060 00 XX	100X60 MM (SİDEM) DIŞ KÖŞE (SABİT)	1	ad.	256,16
001 028 100060 01 XX	100X60 MM (SİDEM) İÇ KÖŞE (HAREKETLİ)	1	ad.	256,16
001 029 100060 01 XX	100X60 MM (SİDEM) DIŞ KÖŞE (HAREKETLİ)	1	ad.	256,16
001 030 100060 00 XX	100X60 MM (SİDEM) T PARÇASI	1	ad.	279,00
001 031 100060 00 XX	100X60 MM (SİDEM) 90 L KÖŞE	1	ad.	279,00
001 033 100060 00 XX	100X60 MM (SİDEM) UÇ TAPA	1	ad.	165,23
001 032 100060 00 XX	100X60 MM (SİDEM) EK PARÇA	1	ad.	165,23
<b>İÇTEN KAPAKLI 100x37/50 İÇİN PMS - SİDEM SERİSİ</b>				<b>CE</b>
001 034 400001 00 XX	100X37/50 (SİDEM) 45X45 PMS TEKLİ	1	ad.	134,69
001 034 400002 00 XX	100X37/50 (SİDEM) 45X45 PMS İKİLİ	1	ad.	143,66
001 034 400003 00 XX	100X37/50 (SİDEM) 45X45 PMS ÜÇLÜ	1	ad.	150,90
001 034 400004 00 XX	100X37/50 (SİDEM) 45X45 PMS DÖRTLÜ	1	ad.	228,40
001 034 500001 00 XX	100X37/50 (SİDEM) 55X55 PMS TEKLİ	1	ad.	192,72
001 034 500002 00 XX	100X37/50 (SİDEM) 55X55 PMS İKİLİ	1	ad.	222,04
001 034 500003 00 XX	100X37/50 (SİDEM) 55X55 PMS ÜÇLÜ	1	ad.	240,49
<b>DIŞTAN KAPAKLI 100'LÜK PMS 55x55 İÇİN - SİDEM SERİSİ</b>				<b>CE</b>
001 034 000001 00 XX	100'LÜK 55X55 PMS TEKLİ SİDEM	1	ad.	251,04
001 034 000002 00 XX	100'LÜK 55X55 PMS İKİLİ SİDEM	1	ad.	306,58
001 034 000003 00 XX	100'LÜK 55X55 PMS ÜÇLÜ SİDEM	1	ad.	347,93
<b>DIŞTAN KAPAKLI 100'LÜK PMS 45x45 İÇİN - SİDEM SERİSİ</b>				<b>CE</b>
001 034 100001 00 XX	100'LÜK 45X45 PMS TEKLİ SİDEM	1	ad.	162,17
001 034 100002 00 XX	100'LÜK 45X45 PMS İKİLİ SİDEM	1	ad.	207,65
001 034 100003 00 XX	100'LÜK 45X45 PMS ÜÇLÜ SİDEM	1	ad.	295,66
001 034 100004 00 XX	100'LÜK 45X45 PMS DÖRTLÜ SİDEM	1	ad.	313,73

\*Kutusuz ürünlerde topraklama klemensi bulunmamaktadır.

Ürün Kodu	Ürün Adı	Kutu Adet	Koli Adet	Normal Fiyat (₺)	Kutusuz ve Klemenssiz Fiyat (₺)
<b>COMFORT W OTOMAT KUTULARI</b>				<b>IP40</b>	
001 057 200001 00 00	COMFORT MÜH. SİGORTA KUTUSU(S/Ü) 1 Lİ	20	120	32,56	-
001 057 200002 00 00	COMFORT MÜH. SİGORTA KUTUSU(S/Ü) 1-2 Lİ	20	80	36,63	-
001 057 200004 00 00	COMFORT MÜH. SİGORTA KUTUSU(S/Ü) 2-4 Lİ	10	60	58,30	-
001 057 100006 00 00	COMFORT SİGORTA KUTUSU (S/Ü) 6 Lİ	1	20	305,58	252,06
001 057 100009 00 00	COMFORT SİGORTA KUTUSU (S/Ü) 9 LU	1	20	387,09	314,63
001 057 100012 00 00	COMFORT SİGORTA KUTUSU (S/Ü) 12 Lİ	1	10	464,42	387,35
001 057 100018 00 00	COMFORT SİGORTA KUTUSU (S/Ü) 18 Lİ	1	10	635,58	539,85
001 057 100024 00 00	COMFORT SİGORTA KUTUSU (S/Ü) 24 LÜ	1	5	818,84	636,77
001 057 100036 00 00	COMFORT SİGORTA KUTUSU (S/Ü) 36 Lİ	1	5	1.026,63	822,41
001 057 000006 00 00	COMFORT SİGORTA KUTUSU (S/A) 6 Lİ	1	20	305,58	252,06
001 057 000009 00 00	COMFORT SİGORTA KUTUSU (S/A) 9 LU	1	20	387,09	314,63
001 057 000012 00 00	COMFORT SİGORTA KUTUSU (S/A) 12 Lİ	1	10	464,42	387,35
001 057 000018 00 00	COMFORT SİGORTA KUTUSU (S/A) 18 Lİ	1	10	635,58	539,85
001 057 000024 00 00	COMFORT SİGORTA KUTUSU (S/A) 24 LÜ	1	5	818,84	636,77
001 057 000036 00 00	COMFORT SİGORTA KUTUSU (S/A) 36 Lİ	1	5	1.026,63	822,41
<b>COMFORT W OTOMAT KUTULARI - ALEV YAYMAYAN</b>				<b>IP40</b>	
001 057 210001 00 00	COMFORT MÜH. SİGORTA (A.YAYMAYAN)(S/Ü) 1 Lİ	20	120	87,31	-
001 057 210002 00 00	COMFORT MÜH. SİGORTA (A.YAYMAYAN)(S/Ü) 1-2 Lİ	20	80	104,92	-
001 057 210004 00 00	COMFORT MÜH. SİGORTA (A.YAYMAYAN)(S/Ü) 2-4 LÜ	10	60	125,96	-
001 057 110006 00 00	COMFORT SİGORTA KUTUSU(S/Ü)(A.YAYMAYAN) 6 Lİ	1	20	542,00	-
001 057 110009 00 00	COMFORT SİGORTA KUTUSU(S/Ü)(A.YAYMAYAN) 9 LU	1	20	667,32	-
001 057 110012 00 00	COMFORT SİGORTA KUTUSU(S/Ü)(A.YAYMAYAN) 12 Lİ	1	10	877,44	-
001 057 110018 00 00	COMFORT SİGORTA KUTUSU(S/Ü)(A.YAYMAYAN) 18 Lİ	1	10	1.251,85	-
001 057 110024 00 00	COMFORT SİGORTA KUTUSU(S/Ü)(A.YAYMAYAN) 24 LÜ	1	5	1.387,26	-
001 057 110036 00 00	COMFORT SİGORTA KUTUSU(S/Ü)(A.YAYMAYAN) 36 Lİ	1	5	1.853,40	-
001 057 010006 00 00	COMFORT SİGORTA KUTUSU(S/A) A.YAYMAYAN 6 Lİ	1	20	542,00	-
001 057 010009 00 00	COMFORT SİGORTA KUTUSU(S/A) A.YAYMAYAN 9 LU	1	20	667,32	-
001 057 010012 00 00	COMFORT SİGORTA KUTUSU(S/A) A.YAYMAYAN 12 Lİ	1	10	877,44	-
001 057 010018 00 00	COMFORT SİGORTA KUTUSU(S/A) A.YAYMAYAN 18 Lİ	1	10	1.251,85	-
001 057 010024 00 00	COMFORT SİGORTA KUTUSU(S/A) A.YAYMAYAN 24 LÜ	1	5	1.387,26	-
001 057 010036 00 00	COMFORT SİGORTA KUTUSU(S/A) A.YAYMAYAN 36 Lİ	1	5	1.853,40	-
<b>COMFORT W OTOMAT KUTULARI - HALOJEN FREE - ALEV YAYAN</b>				<b>IP40</b>	<b>HF</b>
001 057 220001 00 00	COMFORT MÜH. SİGORTA KUTUSU H.FREE (ALEV YAYAN)(S/Ü)1 Lİ	20	120	51,11	-
001 057 220002 00 00	COMFORT MÜH. SİGORTA KUTUSU H.FREE (ALEV YAYAN)(S/Ü)1-2 Lİ	20	80	63,89	-
001 057 220004 00 00	COMFORT MÜH. SİGORTA KUTUSU H.FREE (ALEV YAYAN)(S/Ü)2-4 Lİ	10	60	80,93	-
001 057 120006 00 00	COMFORT SİGORTA KUTUSU H.FREE (ALEV YAYAN) (S/Ü) 6 Lİ	1	20	391,11	-
001 057 120009 00 00	COMFORT SİGORTA KUTUSU H.FREE (ALEV YAYAN) (S/Ü) 9 LU	1	20	462,22	-
001 057 120012 00 00	COMFORT SİGORTA KUTUSU H.FREE (ALEV YAYAN) (S/Ü) 12 Lİ	1	10	622,22	-
001 057 120018 00 00	COMFORT SİGORTA KUTUSU H.FREE (ALEV YAYAN) (S/Ü) 18 Lİ	1	10	857,78	-
001 057 120024 00 00	COMFORT SİGORTA KUTUSU H.FREE (ALEV YAYAN) (S/Ü) 24 LÜ	1	5	1.124,44	-
001 057 120036 00 00	COMFORT SİGORTA KUTUSU H.FREE (ALEV YAYAN) (S/Ü) 36 Lİ	1	5	1.222,22	-
001 057 020006 00 00	COMFORT SİGORTA KUTUSU H.FREE (ALEV YAYAN) (S/A) 6 Lİ	1	20	391,11	-
001 057 020009 00 00	COMFORT SİGORTA KUTUSU H.FREE (ALEV YAYAN) (S/A) 9 LU	1	20	462,22	-
001 057 020012 00 00	COMFORT SİGORTA KUTUSU H.FREE (ALEV YAYAN) (S/A) 12 Lİ	1	10	622,22	-
001 057 020018 00 00	COMFORT SİGORTA KUTUSU H.FREE (ALEV YAYAN) (S/A) 18 Lİ	1	10	857,78	-
001 057 020024 00 00	COMFORT SİGORTA KUTUSU H.FREE (ALEV YAYAN) (S/A) 24 LÜ	1	5	1.124,44	-
001 057 020036 00 00	COMFORT SİGORTA KUTUSU H.FREE (ALEV YAYAN) (S/A) 36 Lİ	1	5	1.222,22	-
<b>COMFORT W OTOMAT ZAYIF AKIM KUTULARI</b>				<b>IP40</b>	
001 057 101012 00 00	COMFORT ZAYIF AKIM KUTUSU (S/Ü)(225x270)	1	10	454,62	-
001 057 101020 00 00	COMFORT ZAYIF AKIM KUTUSU (S/Ü)(270x340)	1	5	767,15	-
001 057 101024 00 00	COMFORT 12 Lİ SİGORTA + ZAYIF AKIM KUTUSU (S/Ü)	1	5	822,31	-
001 057 101036 00 00	COMFORT 24 LÜ SİGORTA + ZAYIF AKIM KUTUSU (S/Ü)	1	5	1.039,26	-
001 057 001012 00 00	COMFORT ZAYIF AKIM KUTUSU (S/A)(205x250)	1	10	449,28	-
001 057 001020 00 00	COMFORT ZAYIF AKIM KUTUSU (S/A)(248x318)	1	5	766,27	-
001 057 001024 00 00	COMFORT 12 Lİ SİGORTA + ZAYIF AKIM KUTUSU (S/A)	1	5	818,88	-
001 057 001036 00 00	COMFORT 24 LÜ SİGORTA + ZAYIF AKIM KUTUSU (S/A)	1	5	1.054,00	-
<b>COMFORT W OTOMAT ZAYIF AKIM KUTULARI - HALOJEN FREE - ALEV YAYAN</b>				<b>IP40</b>	<b>HF</b>
001 057 121012 00 00	COMFORT ZAYIF AKIM KUTUSU H.FREE (ALEV YAYAN) (S/Ü)(225x270)	1	10	588,33	-
001 057 121020 00 00	COMFORT ZAYIF AKIM KUTUSU H.FREE (ALEV YAYAN) (S/Ü)(270x340)	1	5	961,53	-
001 057 121024 00 00	COMFORT 12 Lİ SİGORTA + ZAYIF AKIM KUTUSU H.FREE (ALEV YAYAN) (S/Ü)	1	5	1.037,52	-
001 057 121036 00 00	COMFORT 24 LÜ SİGORTA + ZAYIF AKIM KUTUSU H.FREE (ALEV YAYAN) (S/Ü)	1	5	1.261,15	-
001 057 021012 00 00	COMFORT ZAYIF AKIM KUTUSU H.FREE (ALEV YAYAN) (S/A)(205x250)	1	10	577,88	-
001 057 021020 00 00	COMFORT ZAYIF AKIM KUTUSU H.FREE (ALEV YAYAN) (S/A)(248x318)	1	5	753,78	-
001 057 021024 00 00	COMFORT 12 Lİ SİGORTA + ZAYIF AKIM KUTUSU H.FREE (ALEV YAYAN) (S/A)	1	5	1.019,47	-
001 057 021036 00 00	COMFORT 24 LÜ SİGORTA + ZAYIF AKIM KUTUSU H.FREE (ALEV YAYAN) (S/A)	1	5	1.246,31	-
<b>COMFORT W OTOMAT ZAYIF AKIM KUTULARI - ALEV YAYMAYAN</b>				<b>IP40</b>	
001 057 111012 00 00	COMFORT ZAYIF AKIM KUTUSU(A.YAYMAYAN)(S/Ü)(225x270)	1	10	777,46	-
001 057 111020 00 00	COMFORT ZAYIF AKIM KUTUSU(A.YAYMAYAN)(S/Ü)(270x340)	1	5	1.252,24	-
001 057 111024 00 00	COMFORT 12 Lİ SİGORTA + ZAYIF AKIM KUTUSU(A.YAYMAYAN)(S/Ü)	1	5	1.234,50	-
001 057 111036 00 00	COMFORT 24 LÜ SİGORTA + ZAYIF AKIM KUTUSU(A.YAYMAYAN)(S/Ü)	1	5	1.566,84	-
001 057 011012 00 00	COMFORT ZAYIF AKIM KUTUSU(A.YAYMAYAN)(S/A)(205x250)	1	10	731,29	-
001 057 011020 00 00	COMFORT ZAYIF AKIM KUTUSU(A.YAYMAYAN)(S/A)(248x318)	1	5	1.186,71	-
001 057 011024 00 00	COMFORT 12 Lİ SİGORTA + ZAYIF AKIM KUTUSU(A.YAYMAYAN)(S/A)	1	5	1.168,01	-
001 057 011036 00 00	COMFORT 24 LÜ SİGORTA + ZAYIF AKIM KUTUSU(A.YAYMAYAN)(S/A)	1	5	1.507,57	-
<b>COMFORT W OTOMAT KUTUSU AKSESUARLARI</b>					
001 057 990001 00 00	S/A COMFORT ALÇIPAN MONTAJ SETİ	1		45,19	-
001 057 990002 00 00	COMFORT SU TERAZİSİ	1		60,00	-
000 700 000574 00 00	RAY YÜKSELTME PARÇASI (UZUN/KISA)	1		7,78	-
001 057 001236 00 00	COMFORT ZAYIF AKIM ÖRTME PARÇASI	50		48,89	-

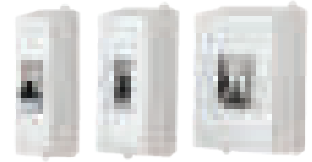

Sıva altı serisinde **betopan, alçıpan** duvarlara montaj yapılabilmektedir özelliği.



Ürün Kodu	Ürün Adı	Kutu Adet	Koli Adet	Kutu Fiyat (₺)
<b>W OTOMAT ÖRTME PARÇALARI</b>				
001 026 000002 00 00	W OTOMAT ÖRTME PARÇASI 12'Lİ - YENİ TİP	50	400	29,27
<b>MEKSBOX W OTOMAT KUTULARI</b>				
IP30				
001 027 200001 00 00	MÜHÜRLÜ W OTOMAT KUTUSU (S/Ü) 1 Lİ	20	160	31,11
001 027 200002 00 00	MÜHÜRLÜ W OTOMAT KUTUSU (S/Ü) 2 Lİ	20	80	34,87
001 027 200004 00 00	MÜHÜRLÜ W OTOMAT KUTUSU (S/Ü) 4 LÜ	10	80	55,99
001 027 100002 00 00	W OTOMAT KUTUSU (S/Ü) MEKSBOX 2 Lİ	1	30	234,30
001 027 000002 00 00	W OTOMAT KUTUSU (S/A) MEKSBOX 2 Lİ	1	30	234,30
001 027 100004 00 00	W OTOMAT KUTUSU (S/Ü) MEKSBOX 4 LÜ	1	20	250,58
001 027 000004 00 00	W OTOMAT KUTUSU (S/A) MEKSBOX 4 LÜ	1	20	250,58
001 027 100006 00 00	W OTOMAT KUTUSU (S/Ü) MEKSBOX 6 Lİ	1	20	297,44
001 027 000006 00 00	W OTOMAT KUTUSU (S/A) MEKSBOX 6 Lİ	1	20	297,44
001 027 100009 00 00	W OTOMAT KUTUSU (S/Ü) MEKSBOX 9 LU	1	20	377,30
001 027 000009 00 00	W OTOMAT KUTUSU (S/A) MEKSBOX 9 LU	1	20	377,30
001 027 100012 00 00	W OTOMAT KUTUSU (S/Ü) MEKSBOX 12 Lİ	1	10	444,44
001 027 000012 00 00	W OTOMAT KUTUSU (S/A) MEKSBOX 12 Lİ	1	10	444,44
001 027 100016 00 00	W OTOMAT KUTUSU (S/Ü) MEKSBOX 16 Lİ	1	10	611,16
001 027 000016 00 00	W OTOMAT KUTUSU (S/A) MEKSBOX 16 Lİ	1	10	611,16
001 027 100024 00 00	W OTOMAT KUTUSU (S/Ü) MEKSBOX 24 LÜ	1	5	765,49
001 027 000024 00 00	W OTOMAT KUTUSU (S/A) MEKSBOX 24 LÜ	1	5	765,49
001 027 100036 00 00	W OTOMAT KUTUSU (S/Ü) MEKSBOX 36 Lİ	1	5	986,37
001 027 000036 00 00	W OTOMAT KUTUSU (S/A) MEKSBOX 36 Lİ	1	5	986,37
<b>MEKSBOX W OTOMAT KUTULARI - ALEV YAYMAYAN</b>				
TS CE IP30				
001 027 210001 00 00	MÜH.W OTOMAT KUTUSU ALEV YAYMAYAN (S/Ü) 1 Lİ	20	160	77,78
001 027 210002 00 00	MÜH.W OTOMAT KUTUSU ALEV YAYMAYAN (S/Ü) 2 Lİ	20	80	92,59
001 027 210004 00 00	MÜH.W OTOMAT KUTUSU ALEV YAYMAYAN (S/Ü) 4 LÜ	10	80	111,11
001 027 110002 00 00	W OTOMAT KUTUSU (S/Ü) ALEV YAYMAYAN 2 Lİ	1	30	411,19
001 027 010002 00 00	W OTOMAT KUTUSU (S/A) ALEV YAYMAYAN 2 Lİ	1	30	411,19
001 027 110004 00 00	W OTOMAT KUTUSU (S/Ü) ALEV YAYMAYAN 4 LÜ	1	20	451,85
001 027 010004 00 00	W OTOMAT KUTUSU (S/A) ALEV YAYMAYAN 4 LÜ	1	20	451,85
001 027 110006 00 00	W OTOMAT KUTUSU (S/Ü) ALEV YAYMAYAN 6 Lİ	1	20	500,00
001 027 010006 00 00	W OTOMAT KUTUSU (S/A) ALEV YAYMAYAN 6 Lİ	1	20	500,00
001 027 110009 00 00	W OTOMAT KUTUSU (S/Ü) ALEV YAYMAYAN 9 LU	1	20	629,63
001 027 010009 00 00	W OTOMAT KUTUSU (S/A) ALEV YAYMAYAN 9 LU	1	20	629,63
001 027 110012 00 00	W OTOMAT KUTUSU (S/Ü) ALEV YAYMAYAN 12 Lİ	1	10	833,33
001 027 010012 00 00	W OTOMAT KUTUSU (S/A) ALEV YAYMAYAN 12 Lİ	1	10	833,33
001 027 110016 00 00	W OTOMAT KUTUSU (S/Ü) ALEV YAYMAYAN 16 Lİ	1	10	1.016,67
001 027 010016 00 00	W OTOMAT KUTUSU (S/A) ALEV YAYMAYAN 16 Lİ	1	10	1.016,67
001 027 110024 00 00	W OTOMAT KUTUSU (S/Ü) ALEV YAYMAYAN 24 LÜ	1	5	1.333,33
001 027 010024 00 00	W OTOMAT KUTUSU (S/A) ALEV YAYMAYAN 24 LÜ	1	5	1.333,33
001 027 110036 00 00	W OTOMAT KUTUSU (S/Ü) ALEV YAYMAYAN 36 Lİ	1	5	1.777,78
001 027 010036 00 00	W OTOMAT KUTUSU (S/A) ALEV YAYMAYAN 36 Lİ	1	5	1.777,78

Ürün Kodu	Ürün Adı	Ort. İç Çap	Ort. Dış Çap	Kutu Mt.	Koli Adet	Fiyat (₺)
<b>HAFİF SERİ PVC SİRALLER - ALEV YAYMAYAN (320N)</b> 						
001 020 010016 00 17	16 Ø A.YAYMAYAN SİRAL (HAFİF SERİ)	11,4	15,85	100 mt.	500	14,22
001 020 010020 00 17	20 Ø A.YAYMAYAN SİRAL (HAFİF SERİ)	14,5	19,85	100 mt.	500	18,70
001 020 010025 00 17	25 Ø A.YAYMAYAN SİRAL (HAFİF SERİ)	18,7	24,8	50 mt.	250	26,55
001 020 010032 00 17	32 Ø A.YAYMAYAN SİRAL (HAFİF SERİ)	24,9	31,8	50 mt.	250	32,99
<b>AĞIR SERİ PVC SİRALLER -ALEV YAYMAYAN (750N)</b> 						
001 020 000016 00 17	16 Ø A.YAYMAYAN SİRAL (AĞIR SERİ)	11,2	15,85	100 mt.	500	16,21
001 020 000020 00 17	20 Ø A.YAYMAYAN SİRAL (AĞIR SERİ)	14,4	19,85	100 mt.	500	20,70
001 020 000025 00 17	25 Ø A.YAYMAYAN SİRAL (AĞIR SERİ)	18,1	24,8	50 mt.	250	27,88
001 020 000032 00 17	32 Ø A.YAYMAYAN SİRAL (AĞIR SERİ)	24,7	31,8	50 mt.	250	33,87
<b>HAFİF SERİ PVC TELLİ SİRALLER - ALEV YAYMAYAN (320N)</b> 						
001 020 120016 00 17	16 Ø TELLİ A.YAYMAYAN (HAFİF SERİ)	11,4	15,85	100 mt.	500	17,32
001 020 120020 00 17	20 Ø TELLİ A.YAYMAYAN (HAFİF SERİ)	14,5	19,85	100 mt.	500	21,80
001 020 120025 00 17	25 Ø TELLİ A.YAYMAYAN (HAFİF SERİ)	18,7	24,8	50 mt.	250	29,65
001 020 120032 00 17	32 Ø TELLİ A.YAYMAYAN (HAFİF SERİ)	24,9	31,8	50 mt.	250	36,48
<b>AĞIR SERİ PVC TELLİ SİRALLER - ALEV YAYMAYAN (750N)</b> 						
001 020 100016 00 17	16 Ø TELLİ A.YAYMAYAN (AĞIR SERİ)	11,2	15,85	100 mt.	500	19,31
001 020 100020 00 17	20 Ø TELLİ A.YAYMAYAN (AĞIR SERİ)	14,4	19,85	100 mt.	500	23,80
001 020 100025 00 17	25 Ø TELLİ A.YAYMAYAN (AĞIR SERİ)	18,1	24,8	50 mt.	250	31,20
001 020 100032 00 17	32 Ø TELLİ A.YAYMAYAN (AĞIR SERİ)	24,7	31,8	50 mt.	250	37,36
<b>HALOJEN FREE SİRALLER -ALEV YAYAN (320N)</b> 						
001 020 140016 00 17	16 Ø HALOJEN FREE SPR. (ALEV YAYAN)	11,2	15,7	100 mt.	500	10,71
001 020 140020 00 17	20 Ø HALOJEN FREE SPR. (ALEV YAYAN)	14,4	19,85	100 mt.	500	12,92
001 020 140025 00 17	25 Ø HALOJEN FREE SPR. (ALEV YAYAN)	19,1	24,7	50 mt.	250	18,83
001 020 140032 00 17	32 Ø HALOJEN FREE SPR. (ALEV YAYAN)	24,85	31,6	50 mt.	250	22,94
001 020 140040 00 17	40 Ø HALOJEN FREE SPR. (ALEV YAYAN)			25 mt.	125	40,04
001 020 140050 00 17	50 Ø HALOJEN FREE SPR. (ALEV YAYAN)			25 mt.	125	48,55
<b>HALOJEN FREE SİRALLER -ALEV YAYAN (750N)</b> 						
001 020 740020 00 17	20 Ø HALOJEN FREE SPR. (ALEV YAYAN)	14,4	19,85	100 mt.	500	29,37
001 020 740025 00 17	25 Ø HALOJEN FREE SPR. (ALEV YAYAN)	18,7	24,7	50 mt.	250	40,27
001 020 740032 00 17	32 Ø HALOJEN FREE SPR. (ALEV YAYAN)	24,2	31,6	50 mt.	250	55,67
<b>HALOJEN FREE SİRALLER TELLİ - ALEV YAYAN (320N)</b> 						
001 020 141016 00 17	16 Ø H.FREE SİRAL(A.YAYAN)(TELLİ)	11,2	15,7	100 mt.	500	12,76
001 020 141020 00 17	20 Ø H.FREE SİRAL(A.YAYAN)(TELLİ)	14,4	19,85	100 mt.	500	14,97
001 020 141025 00 17	25 Ø H.FREE SİRAL(A.YAYAN)(TELLİ)	19,1	24,7	50 mt.	250	19,95
001 020 141032 00 17	32 Ø H.FREE SİRAL(A.YAYAN)(TELLİ)	24,85	31,6	50 mt.	250	24,99
001 020 141040 00 17	40 Ø H.FREE SİRAL(A.YAYAN)(TELLİ)			25 mt.	125	40,34
<b>HALOJEN FREE SİRALLER - ALEV YAYMAYAN (320N)</b> 						
001 020 150016 00 17	16 Ø HALOJEN FREE SPR.(A.YAYMAYAN)	11,2	15,7	100 mt.	500	14,68
001 020 150020 00 17	20 Ø HALOJEN FREE SPR.(A.YAYMAYAN)	14,4	19,85	100 mt.	500	18,39
001 020 150025 00 17	25 Ø HALOJEN FREE SPR.(A.YAYMAYAN)	19,1	24,7	50 mt.	250	25,46
001 020 150032 00 17	32 Ø HALOJEN FREE SPR.(A.YAYMAYAN)	24,85	31,6	50 mt.	250	32,55
001 020 150040 00 17	40 Ø HALOJEN FREE SPR.(A.YAYMAYAN)			25 mt.	125	54,44
001 020 150050 00 17	50 Ø HALOJEN FREE SPR.(A.YAYMAYAN)			25 mt.	125	69,50
<b>HALOJEN FREE SİRALLER - ALEV YAYMAYAN (750N)</b> 						
001 020 750020 00 17	20 Ø HALOJEN FREE SPR. (ALEV YAYMAYAN)	14,4	19,85	100 mt.	500	38,55
001 020 750025 00 17	25 Ø HALOJEN FREE SPR. (ALEV YAYMAYAN)	18,7	24,7	50 mt.	250	54,32
001 020 750032 00 17	32 Ø HALOJEN FREE SPR. (ALEV YAYMAYAN)	24,2	31,6	50 mt.	250	71,76
<b>HALOJEN FREE SİRALLER TELLİ - ALEV YAYMAYAN (320N)</b> 						
001 020 151016 00 17	16 Ø H.FREE SPR.(A.YAYMAYAN)(TELLİ)	11,2	15,7	100 mt.	500	18,15
001 020 151020 00 17	20 Ø H.FREE SPR.(A.YAYMAYAN)(TELLİ)	14,4	19,85	100 mt.	500	21,31
001 020 151025 00 17	25 Ø H.FREE SPR.(A.YAYMAYAN)(TELLİ)	19,1	24,7	50 mt.	250	29,08
001 020 151032 00 17	32 Ø H.FREE SPR.(A.YAYMAYAN)(TELLİ)	24,85	31,6	50 mt.	250	34,25
001 020 151040 00 17	40 Ø H.FREE SPR.(A.YAYMAYAN)(TELLİ)			25 mt.	125	57,29

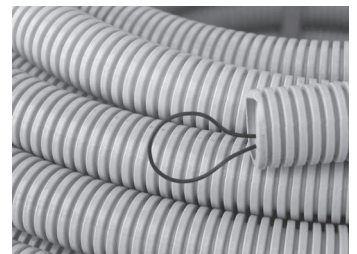
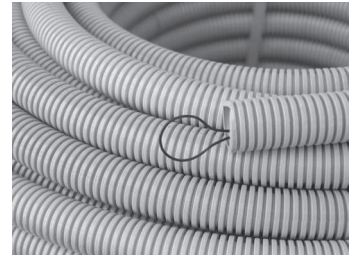

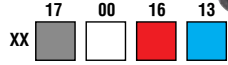

Ürün Kodu	Ürün Adı	Ort. İç Çap	Ort. Dış Çap	Kutu Mt./Ad.	Koli Adet	Fiyat (₺)
<b>MEKS SERİSİ PLASTİK SİRALLER - SİYAH</b>						
001 020 400012 00 11	12 Ø PLASTİK SİRALLER (SİYAH)	12,3	15,9	100 mt.	1000	8,07
001 020 400014 00 11	14 Ø PLASTİK SİRALLER (SİYAH)	15,25	18,75	100 mt.	1000	8,25
001 020 400016 00 11	16 Ø PLASTİK SİRALLER (SİYAH)	15,7	19	100 mt.	1000	8,25
001 020 400018 00 11	18 Ø PLASTİK SİRALLER (SİYAH)	19,6	24,03	100 mt.	500	12,99
001 020 400020 00 11	20 Ø PLASTİK SİRALLER (SİYAH)	19,6	24,03	100 mt.	500	12,99
001 020 400026 00 11	26 Ø PLASTİK SİRALLER (SİYAH)	26,15	30,75	50 mt.	250	19,44
001 020 400032 00 11	32 Ø PLASTİK SİRALLER (SİYAH)	29,1	34,3	50 mt.	250	22,54
001 020 400040 00 11	40 Ø PLASTİK SİRALLER (SİYAH)	36,2	42,2	25 mt.	125	35,50
001 020 400050 00 11	50 Ø PLASTİK SİRALLER (SİYAH)	48,5	54,5	25 mt.	125	42,47
<b>MEKS SERİSİ PLASTİK SİRALLER - SİYAH - TELLİ</b>						
001 020 410014 00 11	14 Ø PLASTİK SİRALLER (SİYAH) TELLİ	15,25	18,75	100 mt.	1000	11,35
001 020 410016 00 11	16 Ø PLASTİK SİRALLER (SİYAH) TELLİ	15,7	19	100 mt.	1000	11,35
001 020 410018 00 11	18 Ø PLASTİK SİRALLER (SİYAH) TELLİ	19,6	24,03	100 mt.	500	15,31
001 020 410020 00 11	20 Ø PLASTİK SİRALLER (SİYAH) TELLİ	19,6	24,03	100 mt.	500	15,31
001 020 410026 00 11	26 Ø PLASTİK SİRALLER (SİYAH) TELLİ	26,15	30,75	50 mt.	250	21,41
001 020 410032 00 11	32 Ø PLASTİK SİRALLER (SİYAH) TELLİ	29,1	34,3	50 mt.	250	24,51
001 020 410040 00 11	40 Ø PLASTİK SİRALLER (SİYAH) TELLİ	36,2	42,2	25 mt.	125	37,47
<b>PLASTİK SİRALLER - RENKLİ</b>						
001 020 400014 00 XX	14 Ø PLS. SİRAL (GRİ-BYZ-KIR-MAVİ)	15,25	18,75	100 mt.	1000	9,37
001 020 400016 00 XX	16 Ø PLS. SİRAL (GRİ-BYZ-KIR-MAVİ)	15,7	19	100 mt.	1000	9,37
001 020 400018 00 XX	18 Ø PLS. SİRAL (GRİ-BYZ-KIR-MAVİ)	19,6	24,03	100 mt.	500	14,90
001 020 400020 00 XX	20 Ø PLS. SİRAL (GRİ-BYZ-KIR-MAVİ)	19,6	24,03	100 mt.	500	14,90
001 020 400026 00 XX	26 Ø PLS. SİRAL (GRİ-BYZ-KIR-MAVİ)	26,15	30,75	50 mt.	250	22,07
001 020 400032 00 XX	32 Ø PLS. SİRAL (GRİ-BYZ-KIR-MAVİ)	29,1	34,3	50 mt.	250	24,76
001 020 400040 00 XX	40 Ø PLS. SİRAL (GRİ-BYZ-KIR-MAVİ)	36,2	42,2	25 mt.	125	40,43
001 020 400050 00 XX	50 Ø PLS. SİRAL (GRİ-BYZ-KIR-MAVİ)	48,5	54,5	25 mt.	125	48,22
001 020 990016 00 17	16 mm SİRAL EK MUFU (GRİ)				200 ad.	10,41
001 020 990020 00 17	20 mm SİRAL EK MUFU (GRİ)				200 ad.	12,20
001 020 990025 00 17	25 mm SİRAL EK MUFU (GRİ)				100 ad.	15,21
001 020 990032 00 17	32 mm SİRAL EK MUFU (GRİ)				200 ad.	20,62
<b>KORUGE BORULAR (250N)</b> <span style="float: right;">TSE CE</span>						
096 045 150050	50 Ø KORUGE KANGAL BORU	43	50	100 mt.		66,19
096 045 150060	63 Ø KORUGE KANGAL BORU	54	63	100 mt.		82,74
096 045 150075	75 Ø KORUGE KANGAL BORU	64	75	100 mt.		99,28
096 045 150100	100 Ø KORUGE BOY BORU (6 MT.)	87	100	6 mt.		111,11
096 045 150115	115 Ø KORUGE BOY BORU (6 MT.)	100	115	6 mt.		125,93
096 045 150004	50 Ø MANŞON				1 ad.	27,78
096 045 150003	75 Ø MANŞON				1 ad.	35,93
096 045 150002	100 Ø MANŞON				1 ad.	42,59
096 045 150001	115 Ø MANŞON				1 ad.	51,85
<b>RÖGAR KUTUSU</b>						
074 048 622020	20X20 RÖGAR KUTUSU TAKIM				1 ad.	268,33
074 048 623030	30X30 RÖGAR KUTUSU TAKIM				1 ad.	603,75
074 048 624040	40X40 RÖGAR KUTUSU TAKIM				1 ad.	1.341,67
074 048 625555	55X55 RÖGAR KUTUSU TAKIM				1 ad.	2.862,22



Ürün Kodu	Ürün Adı	Ort. İç Çap	Ort. Dış Çap	Kutu Mt.	Koli Adet	Fiyat (₺)
<b>EKO SERİSİ ÇELİK SİRALLER</b>						
001 054 150009 00 66	9 Ø EKO ÇELİK SİRALLER	9	12,1	50 mt.	200	24,01
001 054 150011 00 66	11 Ø EKO ÇELİK SİRALLER (3/8")	11	14,1	50 mt.	200	24,59
001 054 150014 00 66	14 Ø EKO ÇELİK SİRALLER (1/2")	14	17,1	50 mt.	200	29,60
001 054 150016 00 66	16 Ø EKO ÇELİK SİRALLER	16	19,1	50 mt.	200	32,53
001 054 150018 00 66	18 Ø EKO ÇELİK SİRALLER	18	21,1	50 mt.	200	35,63
001 054 150021 00 66	21 Ø EKO ÇELİK SİRALLER (3/4")	21	24,1	50 mt.	200	39,73
001 054 150026 00 66	26 Ø EKO ÇELİK SİRALLER (1")	26	29,1	25 mt.	100	54,26
001 054 150029 00 66	29 Ø EKO ÇELİK SİRALLER (1 1/4")	29	32,1	25 mt.	100	58,65
001 054 150032 00 66	32 Ø EKO ÇELİK SİRALLER	32	35,1	25 mt.	100	62,63
001 054 150037 00 66	37 Ø EKO ÇELİK SİRALLER (1 1/2")	37	41,1	25 mt.	100	82,30
001 054 150042 00 66	42 Ø EKO ÇELİK SİRALLER	42	45,1	25 mt.	100	95,89
001 054 150050 00 66	50 Ø EKO ÇELİK SİRALLER (2")	50	53,1	25 mt.	100	133,11
001 054 150063 00 66	63 Ø EKO ÇELİK SİRALLER	63	66,1	15 mt.	60	181,06

### EKO SERİSİ ÇELİK SİRALLER - KILAVUZ TELLİ

001 054 221011 00 66	11 Ø EKO Ç. SİRALLER (TELLİ) (3/8")	11	14,1	50 mt.	200	28,74
001 054 221014 00 66	14 Ø EKO Ç. SİRALLER (TELLİ) (1/2")	14	17,1	50 mt.	200	34,88
001 054 221016 00 66	16 Ø EKO Ç. SİRALLER (TELLİ)	16	19,1	50 mt.	200	36,93
001 054 221018 00 66	18 Ø EKO Ç. SİRALLER (TELLİ)	18	21,1	50 mt.	200	42,99
001 054 221021 00 66	21 Ø EKO Ç. SİRALLER (TELLİ) (3/4")	21	24,1	50 mt.	200	44,32
001 054 221026 00 66	26 Ø EKO Ç. SİRALLER (TELLİ) (1")	26	29,1	25 mt.	100	59,80
001 054 221029 00 66	29 Ø EKO Ç. SİRALLER (TELLİ) (1 1/4")	29	32,1	25 mt.	100	63,01
001 054 221032 00 66	32 Ø EKO Ç. SİRALLER (TELLİ)	32	35,1	25 mt.	100	72,20
001 054 221037 00 66	37 Ø EKO Ç. SİRALLER (TELLİ) (1 1/2")	37	41,1	25 mt.	100	87,54
001 054 221042 00 66	42 Ø EKO Ç. SİRALLER (TELLİ)	42	45,1	25 mt.	100	101,00
001 054 221050 00 66	50 Ø EKO Ç. SİRALLER (TELLİ) (2")	50	53,1	25 mt.	100	138,32
001 054 221063 00 66	63 Ø EKO ÇELİK SİRALLER	63	66,1	15 mt.	60	189,09

### EKO SERİSİ İZOLELİ ÇELİK SİRALLER

001 054 160009 00 11	9 Ø EKO İZOLELİ Ç. SİRALLER	9	13,2	50 mt.		30,21
001 054 160011 00 11	11 Ø EKO İZOLELİ Ç. SİRALLER (3/8")	11	15,2	50 mt.		31,13
001 054 160014 00 11	14 Ø EKO İZOLELİ Ç. SİRALLER (1/2")	14	18,4	50 mt.		37,03
001 054 160016 00 11	16 Ø EKO İZOLELİ Ç. SİRALLER	16	20,4	50 mt.		39,27
001 054 160018 00 11	18 Ø EKO İZOLELİ Ç. SİRALLER	18	22,4	50 mt.		45,35
001 054 160021 00 11	21 Ø EKO İZOLELİ Ç. SİRALLER (3/4")	21	25,4	50 mt.		53,91
001 054 160026 00 11	26 Ø EKO İZOLELİ Ç. SİRALLER (1")	26	30,4	25 mt.		66,14
001 054 160029 00 11	29 Ø EKO İZOLELİ Ç. SİRALLER (1 1/4")	29	33,4	25 mt.		72,19
001 054 160032 00 11	32 Ø EKO İZOLELİ Ç. SİRALLER	32	36,4	25 mt.		80,32
001 054 160037 00 11	37 Ø EKO İZOLELİ Ç. SİRALLER (1 1/2")	37	42,4	25 mt.		102,85
001 054 160042 00 11	42 Ø EKO İZOLELİ Ç. SİRALLER	42	46,4	25 mt.		124,71
001 054 160050 00 11	50 Ø EKO İZOLELİ Ç. SİRALLER (2")	50	54,4	25 mt.		167,18
001 054 160063 00 11	63 Ø EKO İZOLELİ Ç. SİRALLER	63	66,1	15 mt.		215,19

### EKO SERİSİ İZOLELİ ÇELİK SİRALLER - KILAVUZ TELLİ

001 054 231011 00 11	11 Ø EKO İZO.Ç. SPR. (TELLİ) (3/8")	11	15,2	50 mt.		33,51
001 054 231014 00 11	14 Ø EKO İZO.Ç. SPR. (TELLİ) (1/2")	14	18,4	50 mt.		40,59
001 054 231016 00 11	16 Ø EKO İZO.Ç. SPR. (TELLİ)	16	20,4	50 mt.		43,28
001 054 231018 00 11	18 Ø EKO İZO.Ç. SPR. (TELLİ)	18	22,4	50 mt.		48,75
001 054 231021 00 11	21 Ø EKO İZO.Ç. SPR. (TELLİ) (3/4")	21	25,4	50 mt.		57,38
001 054 231026 00 11	26 Ø EKO İZO.Ç. SPR. (TELLİ) (1")	26	30,4	25 mt.		70,49
001 054 231029 00 11	29 Ø EKO İZO.Ç. SPR. (TELLİ) (1 1/4")	29	33,4	25 mt.		75,63
001 054 231032 00 11	32 Ø EKO İZO.Ç. SPR. (TELLİ)	32	36,4	25 mt.		88,93
001 054 231037 00 11	37 Ø EKO İZO.Ç. SPR. (TELLİ) (1 1/2")	37	42,4	25 mt.		109,47
001 054 231042 00 11	42 Ø EKO İZO.Ç. SPR. (TELLİ)	42	46,4	25 mt.		130,96
001 054 231050 00 11	50 Ø EKO İZO.Ç. SPR. (TELLİ) (2")	50	54,4	25 mt.		175,21
001 054 231063 00 11	63 Ø EKO İZOLELİ Ç. SİRALLER	63	66,1	15 mt.		224,53

### MEKS SERİSİ ÇELİK SİRALLER

001 054 120009 00 66	9 Ø ÇELİK SİRALLER	9	12,1	50 mt.	200	25,68
001 054 120011 00 66	11 Ø ÇELİK SİRALLER (3/8")	11	14,1	50 mt.	200	26,73
001 054 120014 00 66	14 Ø ÇELİK SİRALLER (1/2")	14	17,1	50 mt.	200	32,17
001 054 120016 00 66	16 Ø ÇELİK SİRALLER	16	19,1	50 mt.	200	35,35
001 054 120018 00 66	18 Ø ÇELİK SİRALLER	18	21,1	50 mt.	200	38,73
001 054 120021 00 66	21 Ø ÇELİK SİRALLER (3/4")	21	24,1	50 mt.	200	43,02
001 054 120026 00 66	26 Ø ÇELİK SİRALLER (1")	26	29,1	25 mt.	100	56,35
001 054 120029 00 66	29 Ø ÇELİK SİRALLER (1 1/4")	29	32,1	25 mt.	100	60,44
001 054 120032 00 66	32 Ø ÇELİK SİRALLER	32	35,1	25 mt.	100	67,14
001 054 120037 00 66	37 Ø ÇELİK SİRALLER (1 1/2")	37	41,1	25 mt.	100	84,39
001 054 120042 00 66	42 Ø ÇELİK SİRALLER	42	45,1	25 mt.	100	100,54
001 054 120050 00 66	50 Ø ÇELİK SİRALLER (2")	50	53,1	25 mt.	100	141,94
001 054 120063 00 66	63 Ø ÇELİK SİRALLER	63	66,1	15 mt.	60	192,70

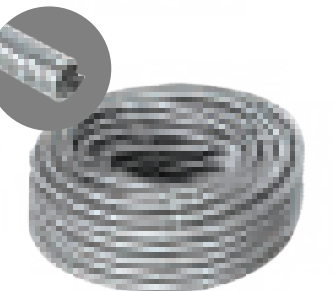
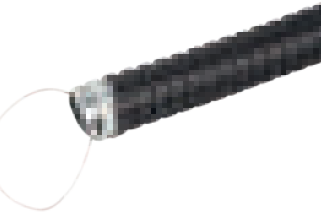
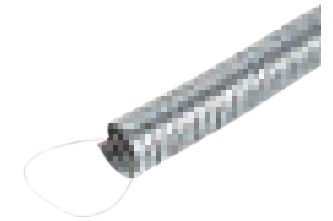

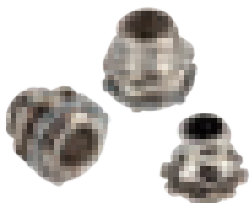
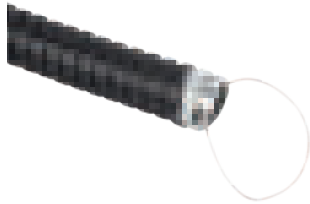

Ürün Kodu	Ürün Adı	Ort. İç Çap	Ort. Dış Çap	Kutu Mt./Ad.	Koli Adet	Fiyat (₺)
<b>MEKS SERİSİ ÇELİK SİRALER (KILAVUZ TELLİ)</b>						
001 054 121011 00 66	11 Ø Ç. SİRAL(TELLİ)(3/8")	11	14,1	50 mt.	200	29,88
001 054 121014 00 66	14 Ø Ç. SİRAL(TELLİ)(1/2")	14	17,1	50 mt.	200	36,27
001 054 121016 00 66	16 Ø Ç. SİRAL (TELLİ)	16	19,1	50 mt.	200	38,39
001 054 121018 00 66	18 Ø Ç. SİRAL(TELLİ)	18	21,1	50 mt.	200	46,73
001 054 121021 00 66	21 Ø Ç. SİRAL(TELLİ) (3/4")	21	24,1	50 mt.	200	48,09
001 054 121026 00 66	26 Ø Ç. SİRAL(TELLİ)(1")	26	29,1	25 mt.	100	63,99
001 054 121029 00 66	29 Ø Ç. SİRAL(TELLİ)(1 1/4")	29	32,1	25 mt.	100	67,58
001 054 121032 00 66	32 Ø Ç. SİRAL(TELLİ)	32	35,1	25 mt.	100	77,10
001 054 121037 00 66	37 Ø Ç. SİRAL(TELLİ)(1 1/2")	37	41,1	25 mt.	100	93,95
001 054 121042 00 66	42 Ø Ç. SİRAL(TELLİ)	42	45,1	25 mt.	100	109,78
001 054 121050 00 66	50 Ø Ç. SİRAL(TELLİ) (2")	50	53,1	25 mt.	100	149,87
001 054 121063 00 66	63 Ø Ç. SİRAL(TELLİ) (2")	63	66,1	15 mt.	60	203,56
<b>MEKS SERİSİ İZOLELİ ÇELİK SİRALER</b>						
001 054 130009 00 11	9 Ø İZOLELİ Ç. SİRAL	9	13,2	50 mt.		32,23
001 054 130011 00 11	11 Ø İZOLELİ Ç. SİRAL(3/8")	11	15,2	50 mt.		32,92
001 054 130014 00 11	14 Ø İZOLELİ Ç. SİRAL(1/2")	14	18,4	50 mt.		37,89
001 054 130016 00 11	16 Ø İZOLELİ Ç. SİRAL	16	20,4	50 mt.		43,49
001 054 130018 00 11	18 Ø İZOLELİ Ç. SİRAL	18	22,4	50 mt.		50,23
001 054 130026 00 11	26 Ø İZOLELİ Ç. SİRAL(1")	26	30,4	25 mt.		72,17
001 054 130029 00 11	29 Ø İZOLELİ Ç. SİRAL(1 1/4")	29	33,4	25 mt.		82,32
001 054 130032 00 11	32 Ø İZOLELİ Ç. SİRAL	32	36,4	25 mt.		95,37
001 054 130037 00 11	37 Ø İZOLELİ Ç. SİRAL (1 1/2")	37	42,4	25 mt.		113,51
001 054 130042 00 11	42 Ø İZOLELİ Ç. SİRAL	42	46,4	25 mt.		141,96
001 054 130050 00 11	50 Ø İZOLELİ Ç. SİRAL(2")	50	54,4	25 mt.		190,25
001 054 130063 00 11	63 Ø İZOLELİ ÇELİK SİRAL	63	67,2	15 mt.		244,52
<b>MEKS SERİSİ İZOLELİ ÇELİK SİRALER - KILAVUZ TELLİ</b>						
001 054 140011 00 11	11 Ø İZO.Ç. SPR.(TELLİ)(3/8")	11	15,2	50 mt.		37,11
001 054 140014 00 11	14 Ø İZO.Ç. SPR.(TELLİ)(1/2")	14	18,4	50 mt.		44,96
001 054 140016 00 11	16 Ø İZO.Ç. SPR. (TELLİ)	16	20,4	50 mt.		47,33
001 054 140018 00 11	18 Ø İZO.Ç. SPR.(TELLİ)	18	22,4	50 mt.		51,94
001 054 140026 00 11	26 Ø İZO.Ç. SPR.(TELLİ)(1")	26	30,4	25 mt.		76,97
001 054 140029 00 11	29 Ø İZO.Ç. SPR.(TELLİ)(1 1/4")	29	33,4	25 mt.		86,70
001 054 140032 00 11	32 Ø İZO.Ç. SPR.(TELLİ)	32	36,4	25 mt.		101,50
001 054 140037 00 11	37 Ø İZO.Ç. SPR.(TELLİ)(1 1/2")	37	42,4	25 mt.		119,95
001 054 140042 00 11	42 Ø İZO.Ç. SPR.(TELLİ)	42	46,4	25 mt.		150,59
001 054 140050 00 11	50 Ø İZO.Ç. SPR.(TELLİ) (2")	50	54,4	25 mt.		198,61
001 054 140063 00 11	63 Ø İZO.Ç. SPR.(TELLİ)	63	67,2	15 mt.		254,18
<b>NİKEL KAPLI ÇELİK SİRAL RAKORU</b>						
012 097 030009	CLK- 9 ÇELİK SİRAL RAKORU			1 ad.		4,92 □
012 097 030011	CLK-11 ÇELİK SİRAL RAKORU			1 ad.		5,86 □
012 097 030014	CLK-13,5 ÇELİK SİRAL RAKORU			1 ad.		7,04 □
012 097 030016	CLK-16 ÇELİK SİRAL RAKORU			1 ad.		7,78 □
012 097 030018	CLK-18 ÇELİK SİRAL RAKORU			1 ad.		8,34 □
012 097 030026	CLK-26 ÇELİK SİRAL RAKORU			1 ad.		13,82 □

Ürün Kodu	Ürün Adı	Kutu Mt.	Koli Adet	Fiyat (₺)
<b>PVC ALEV YAYMAYAN BOY BORULAR</b>				
001 045 120014 30 17	14 Ø PVC ALEV YAYMAYAN BOY BORU (BOY: 3 MT)	102 mt.		19,41
001 045 120016 30 17	16 Ø PVC ALEV YAYMAYAN BOY BORU (BOY: 3 MT)	102 mt.		23,13
001 045 120018 30 17	18 Ø PVC ALEV YAYMAYAN BOY BORU (BOY: 3 MT)	102 mt.		25,54
001 045 120020 30 17	20 Ø PVC ALEV YAYMAYAN BOY BORU (BOY: 3 MT)	102 mt.		34,46
001 045 120025 30 17	25 Ø PVC ALEV YAYMAYAN BOY BORU (BOY: 3 MT)	51 mt.		47,08
001 045 120032 30 17	32 Ø PVC ALEV YAYMAYAN BOY BORU (BOY: 3 MT)	30 mt.		78,46
001 045 120040 30 17	40 Ø PVC ALEV YAYMAYAN BOY BORU (BOY: 3 MT)	30 mt.		145,08
<b>PVC ALEV YAYMAYAN KENDİNDEN MUFLU BOY BORULAR</b>				
001 045 110014 30 17	14 Ø PVC ALEV YAYMAYAN KENDİNDEN MUFLU BOY BORU (3M)	102 mt.		21,94
001 045 110016 30 17	16 Ø PVC ALEV YAYMAYAN KENDİNDEN MUFLU BOY BORU (3M)	102 mt.		26,14
001 045 110018 30 17	18 Ø PVC ALEV YAYMAYAN KENDİNDEN MUFLU BOY BORU (3M)	102 mt.		28,87
001 045 110020 30 17	20 Ø PVC ALEV YAYMAYAN KENDİNDEN MUFLU BOY BORU (3M)	102 mt.		38,94
001 045 110025 30 17	25 Ø PVC ALEV YAYMAYAN KENDİNDEN MUFLU BOY BORU (3M)	51 mt.		53,20
001 045 110032 30 17	32 Ø PVC ALEV YAYMAYAN KENDİNDEN MUFLU BOY BORU (3M)	30 mt.		88,66
001 045 110040 30 17	40 Ø PVC ALEV YAYMAYAN KENDİNDEN MUFLU BOY BORU (3M)	30 mt.		163,94
<b>DİRSEK VE MUFLAR - ALEV YAYMAYAN</b>				
001 051 010014 00 17	14 Ø DİRSEK ALEV YAYMAYAN	100 ad.	700	11,11
001 051 010016 00 17	16 Ø DİRSEK ALEV YAYMAYAN	100 ad.	600	11,85
001 051 010018 00 17	18 Ø DİRSEK ALEV YAYMAYAN	100 ad.	400	12,96
001 051 010020 00 17	20 Ø DİRSEK ALEV YAYMAYAN	100 ad.	300	14,07
001 051 010025 00 17	25 Ø DİRSEK ALEV YAYMAYAN	50 ad.	150	27,78
001 051 010032 00 17	32 Ø DİRSEK ALEV YAYMAYAN	50 ad.	100	41,85
001 051 030014 00 17	14-16 Ø MUF ALEV YAYMAYAN	100 ad.	700	6,67
001 051 030018 00 17	18-20 Ø MUF ALEV YAYMAYAN	100 ad.	500	7,04
001 051 030025 00 17	25 Ø MUF ALEV YAYMAYAN	50 ad.	300	20,37
001 051 030032 00 17	32 Ø MUF ALEV YAYMAYAN	50 ad.	200	27,78
<b>GEÇMELİ TİP ANTİGRON BORU KROŞESİ</b> XX yerine Gri için 17, Beyaz için 00 rakamını yazınız.				
001 048 010016 00 XX	16 Ø ANTİGRON BORU KROŞESİ (GEÇMELİ)	100 ad.	2000	2,96
001 048 010018 00 XX	18 Ø ANTİGRON BORU KROŞESİ (GEÇMELİ)	100 ad.	3000	5,19
001 048 010020 00 XX	20 Ø ANTİGRON BORU KROŞESİ (GEÇMELİ)	100 ad..	4500	5,37
001 048 010025 00 XX	25 Ø ANTİGRON BORU KROŞESİ (GEÇMELİ)	100 ad.	1000	5,56
001 048 010032 00 XX	32 Ø ANTİGRON BORU KROŞESİ (GEÇMELİ)	100 ad.	800	5,93
001 048 010040 00 XX	40 Ø ANTİGRON BORU KROŞESİ (GEÇMELİ)	50 ad.	750	12,22
001 048 020016 00 XX	16 Ø ANTİGRON BORU KROŞESİ (RAY TİPİ - GEÇMELİ)	100 ad.	2000	4,40
001 048 020020 00 XX	20 Ø ANTİGRON BORU KROŞESİ (RAY TİPİ - GEÇMELİ)	100 ad.	1500	4,60
001 048 020025 00 XX	25 Ø ANTİGRON BORU KROŞESİ (RAY TİPİ - GEÇMELİ)	100 ad.	1000	4,95
001 048 020032 00 XX	32 Ø ANTİGRON BORU KROŞESİ (RAY TİPİ - GEÇMELİ)	100 ad.	800	5,10
074 048 050016	16 Ø ANTİGRON BORU KROŞESİ KAPAKLI(GEÇMELİ)	100 ad.	4000	4,44
074 048 050017	20 Ø ANTİGRON BORU KROŞESİ KAPAKLI(GEÇMELİ)	100 ad.	3500	6,85
074 048 050025	25 Ø ANTİGRON BORU KROŞESİ KAPAKLI(GEÇMELİ)	100 ad.	3000	7,04
074 048 050032	32 Ø ANTİGRON BORU KROŞESİ KAPAKLI(GEÇMELİ)	50 ad.	1500	7,41
<b>FİBER SUSTALAR</b>				
999 999 000779	FİBER KILAVUZ 11MM (100-120-150-200M)	1 mt.		229,63
999 999 000780	FİBER KILAVUZ MAKARASI	1 ad.		6.750,00
<b>PLASTİK SUSTALAR - KILAVUZ TELLİ</b>				
049 019 400010	10 MT. KILAVUZ TELLİ PLASTİK SUSTA	1 ad.	25	198,57
049 019 400015	15 MT. KILAVUZ TELLİ PLASTİK SUSTA	1 ad.	20	297,85
049 019 400020	20 MT. KILAVUZ TELLİ PLASTİK SUSTA	1 ad.	15	397,13
049 019 400025	25 MT. KILAVUZ TELLİ PLASTİK SUSTA	1 ad.	15	496,42
<b>ÇELİK SUSTA ve ZİNCİR</b>				
001 019 000010 00 00	SUSTA (1.KALİTE) (10M)	40 ad.	40	281,94
001 019 000015 00 00	SUSTA (1.KALİTE) (15M)	30 ad.	30	405,01
001 019 000020 00 00	SUSTA (1.KALİTE) (20M)	20 ad.	20	525,67
001 019 000025 00 00	SUSTA (1.KALİTE) (25M)	15 ad.	15	649,41
001 019 100010 00 00	TAKVİYELİ SUSTA(1.KALİTE)(10M)	40 ad.	40	303,17
001 019 100015 00 00	TAKVİYELİ SUSTA(1.KALİTE)(15M)	30 ad.	30	423,53
001 019 100020 00 00	TAKVİYELİ SUSTA(1.KALİTE)(20M)	20 ad.	20	564,64
001 019 100025 00 00	TAKVİYELİ SUSTA(1.KALİTE)(25M)	15 ad.	15	694,70
001 018 000001 00 00	FLORESAN ZİNCİRİ	100 mt.	500	22,22



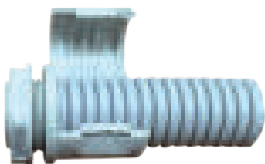
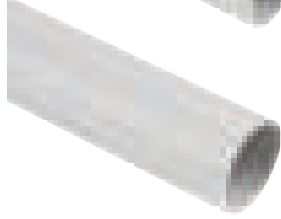
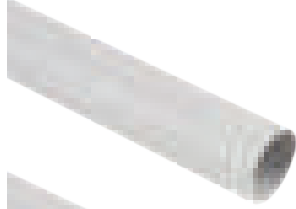

Ürün Kodu	Ürün Adı	Kutu Mt./Ad.	Koli Adet	Fiyat (₺)
<b>BOY BORULAR - HALOJEN FREE - ALEV YAYMAYAN - FLARET - 320N</b> 				
001 045 500016 30 17	16 Ø HALOJEN FREE A.YAYMAYAN BORU(3M)(320N)	102 mt.		91,89
001 045 500020 30 17	20 Ø HALOJEN FREE A.YAYMAYAN BORU(3M)(320N)	102 mt.		111,09
001 045 500025 30 17	25 Ø HALOJEN FREE A.YAYMAYAN BORU(3M)(320N)	102 mt.		153,01
001 045 500032 30 17	32 Ø HALOJEN FREE A.YAYMAYAN BORU(3M)(320N)	102 mt.		215,30
001 045 500040 30 17	40 Ø HALOJEN FREE A.YAYMAYAN BORU(3M)(320N)	51 mt.		308,56
001 045 500050 30 17	50 Ø HALOJEN FREE A.YAYMAYAN BORU(3M)(320N)	30 mt.		500,53
<b>BOY BORULAR - HALOJEN FREE - ALEV YAYMAYAN - FLARET - 750N</b> 				
001 045 510016 30 17	16 Ø HALOJEN FREE A.YAYMAYAN BORU(3M)(750N)	102 mt.		96,69
001 045 510020 30 17	20 Ø HALOJEN FREE A.YAYMAYAN BORU(3M)(750N)	102 mt.		120,68
001 045 510025 30 17	25 Ø HALOJEN FREE A.YAYMAYAN BORU(3M)(750N)	102 mt.		162,61
001 045 510032 30 17	32 Ø HALOJEN FREE A.YAYMAYAN BORU(3M)(750N)	102 mt.		228,99
001 045 510040 30 17	40 Ø HALOJEN FREE A.YAYMAYAN BORU(3M)(750N)	51 mt.		326,84
001 045 510050 30 17	50 Ø HALOJEN FREE A.YAYMAYAN BORU(3M)(750N)	30 mt.		571,45
<b>BOY BORULAR - HALOJEN FREE - ALEV YAYMAYAN - FLARET - 1250N</b> 				
001 045 520016 30 17	16 Ø HALOJEN FREE A.YAYMAYAN BORU(3M)(1250N)	102 mt.		105,02
001 045 520020 30 17	20 Ø HALOJEN FREE A.YAYMAYAN BORU(3M)(1250N)	102 mt.		129,01
001 045 520025 30 17	25 Ø HALOJEN FREE A.YAYMAYAN BORU(3M)(1250N)	102 mt.		176,91
001 045 520032 30 17	32 Ø HALOJEN FREE A.YAYMAYAN BORU(3M)(1250N)	102 mt.		255,49
001 045 520040 30 17	40 Ø HALOJEN FREE A.YAYMAYAN BORU(3M)(1250N)	51 mt.		348,61
001 045 520050 30 17	50 Ø HALOJEN FREE A.YAYMAYAN BORU(3M)(1250N)	30 mt.		636,98
<b>BORU - SİRAL EK MUF - ALEV YAYMAYAN</b>				
999 999 777616	16 LİK BORU-SİRAL EK MUFU A.YAYMAYAN	100 ad.	4000	22,22
999 999 777620	20 LİK BORU-SİRAL EK MUFU A.YAYMAYAN	100 ad.	2000	25,93
999 999 777625	25 LİK BORU-SİRAL EK MUFU A.YAYMAYAN	100 ad.	2000	33,33
999 999 777632	32 LİK BORU-SİRAL EK MUFU A.YAYMAYAN	100 ad.	1000	37,04
<b>DÜZ BORU T DİRSEK - ALEV YAYMAYAN</b>				
999 999 999888	16 LİK DÜZ BORU T DİRSEK A.YAYMAYAN	100 ad.	1500	42,59
999 999 999889	20 LİK DÜZ BORU T DİRSEK A.YAYMAYAN	100 ad.	1000	48,15
999 999 999890	25 LİK DÜZ BORU T DİRSEK A.YAYMAYAN	50 ad.	800	59,26
999 999 999891	32 LİK DÜZ BORU T DİRSEK A.YAYMAYAN	25 ad.	500	77,78
<b>DÜZ BORU RAKORU - ALEV YAYMAYAN</b>				
999 999 998816	Ø16 DÜZ BORU REKORU A. YAYMAYAN	100 ad.	4000	40,74
999 999 998820	Ø20 DÜZ BORU REKORU A. YAYMAYAN	100 ad.	2500	48,15
999 999 998825	Ø25 DÜZ BORU REKORU A. YAYMAYAN	100 ad.	2000	59,26
999 999 998832	Ø32 DÜZ BORU REKORU A. YAYMAYAN	100 ad.	1000	77,78
<b>ANTİGRON BORU KROŞESİ (GEÇMELİ) - ALEV YAYMAYAN</b>				
074 048 060016	Ø16 ANT. BORU KRO. (GEÇ. TİP) KAPAKLI A.YAYMAYAN	100 ad.	4000	11,11
074 048 060020	Ø20 ANT. BORU KRO. (GEÇ. TİP) KAPAKLI A.YAYMAYAN	100 ad.	3500	11,85
074 048 060025	Ø25 ANT. BORU KRO. (GEÇ. TİP) KAPAKLI A.YAYMAYAN	100 ad.	3000	14,44
074 048 060032	Ø32 ANT. BORU KRO. (GEÇ. TİP) KAPAKLI A.YAYMAYAN	100 ad.	2000	17,78
<b>SİRAL RAKORU - ALEV YAYMAYAN</b>				
999 999 777516	Ø16 KAPAKLI SİRAL REKORU A.YAYMAYAN	100 ad.	4000	42,59
999 999 777520	Ø20 KAPAKLI SİRAL REKORU A.YAYMAYAN	100 ad.	3000	48,15
999 999 777525	Ø25 KAPAKLI SİRAL REKORU A.YAYMAYAN	100 ad.	1800	62,96
999 999 777532	Ø32 KAPAKLI SİRAL REKORU A.YAYMAYAN	100 ad.	1000	81,48

## PVC BORU AKSESUARLARI

### PVC KAPAKSIZ BUAT

Ürün Kodu	Ürün Adı	Kutu/Koli Adedi	Fiyat (\$)
999 998 000001	PVC BUAT 20 (1'Lİ)	400	0,75 \$
999 998 000002	PVC BUAT 20 (2'Lİ)	400	0,75 \$
999 998 000003	PVC BUAT 20 (3'LÜ)	400	0,80 \$
999 998 000004	PVC BUAT 20 (4'LÜ)	400	0,80 \$
999 998 000005	PVC BUAT 25 (1'Lİ)	300	1,03 \$
999 998 000006	PVC BUAT 25 (2'Lİ)	300	1,03 \$
999 998 000007	PVC BUAT 25 (3'LÜ)	300	1,08 \$
999 998 000008	PVC BUAT 25 (4'LÜ)	300	1,08 \$



### PVC İNGİLİZ TİP KASALAR

Ürün Kodu	Ürün Adı	Kutu/Koli Adedi	Fiyat (\$)
999 998 000009	PVC İNGİLİZ TİP KASA 1'Lİ	200	0,80 \$
999 998 000010	PVC İNGİLİZ TİP KASA 2'Lİ	100	1,50 \$



### BORU BÜKME YAYLARI

Ürün Kodu	Ürün Adı	Kutu/Koli Adedi	Fiyat (€)
999 999 777094	Q16 BORU BÜKME YAYI	1	36,31 €
999 999 777093	Q20 BORU BÜKME YAYI	1	46,85 €
999 999 777099	Q25 BORU BÜKME YAYI	1	58,56 €
999 999 777095	Q32 BORU BÜKME YAYI	1	67,94 €
999 999 777096	Q40 BORU BÜKME YAYI	1	107,76 €
999 999 777097	Q50 BORU BÜKME YAYI	1	140,56 €



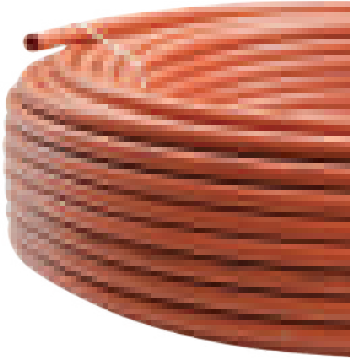

Ürün Kodu	Ürün Adı	Kutu Mt./Ad.	Fiyat (₺)
<b>YENİ MUTLUSAN EKO SERİSİ TURUNCU BORULAR - HALOJEN FREE - ALEV YAYAN - 320N - 6 ATÜ</b>			
001 165 710014 00 12	Ø14/6 ATÜ BORU (H.FREE TURUNCU) (A.YAYAN) (EKO)	200 mt.	11,24
001 165 710016 00 12	Ø16/6 ATÜ BORU (H.FREE TURUNCU) (A.YAYAN) (EKO)	200 mt.	13,49
001 165 710018 00 12	Ø18/6 ATÜ BORU (H.FREE TURUNCU) (A.YAYAN) (EKO)	200 mt.	15,64
001 165 710020 00 12	Ø20/6 ATÜ BORU (H.FREE TURUNCU) (A.YAYAN) (EKO)	200 mt.	18,36
001 165 710025 00 12	Ø25/6 ATÜ BORU (H.FREE TURUNCU) (A.YAYAN) (EKO)	100 mt.	27,97
001 165 710032 00 12	Ø32/6 ATÜ BORU (H.FREE TURUNCU) (A.YAYAN) (EKO)	100 mt.	44,08
001 165 710040 00 12	Ø40/6 ATÜ BORU (H.FREE TURUNCU) (A.YAYAN) (EKO)	100 mt.	69,16
001 165 710050 00 12	Ø50/6 ATÜ BORU (H.FREE TURUNCU) (A.YAYAN) (EKO)	100 mt.	120,04
<b>YENİ MUTLUSAN EKO SERİSİ MAVİ BORULAR - HALOJEN FREE - ALEV YAYAN - 320N - 6 ATÜ</b>			
001 165 710014 00 13	Ø14/6 ATÜ BORU (H.FREE MAVİ) (A.YAYAN) (EKO)	200 mt.	11,24
001 165 710016 00 13	Ø16/6 ATÜ BORU (H.FREE MAVİ) (A.YAYAN) (EKO)	200 mt.	13,49
001 165 710018 00 13	Ø18/6 ATÜ BORU (H.FREE MAVİ) (A.YAYAN) (EKO)	200 mt.	15,64
001 165 710020 00 13	Ø20/6 ATÜ BORU (H.FREE MAVİ) (A.YAYAN) (EKO)	200 mt.	18,36
001 165 710025 00 13	Ø25/6 ATÜ BORU (H.FREE MAVİ) (A.YAYAN) (EKO)	100 mt.	27,97
001 165 710032 00 13	Ø32/6 ATÜ BORU (H.FREE MAVİ) (A.YAYAN) (EKO)	100 mt.	44,08
001 165 710040 00 13	Ø40/6 ATÜ BORU (H.FREE MAVİ) (A.YAYAN) (EKO)	100 mt.	69,16
001 165 710050 00 13	Ø50/6 ATÜ BORU (H.FREE MAVİ) (A.YAYAN) (EKO)	100 mt.	120,04
<b>MEKS SERİSİ TURUNCU BORULAR - HALOJEN FREE - ALEV YAYAN - 320N - 6 ATÜ</b>			
001 165 506014 00 12	Ø14/6 ATÜ BORU (H.FREE)(A.YAYAN)	100 mt.	14,94
001 165 506016 00 12	Ø16/6 ATÜ BORU (H.FREE)(A.YAYAN)	100 mt.	17,89
001 165 506018 00 12	Ø18/6 ATÜ BORU (H.FREE)(A.YAYAN)	100 mt.	19,95
001 165 506020 00 12	Ø20/6 ATÜ BORU (H.FREE)(A.YAYAN)	100 mt.	21,82
001 165 506025 00 12	Ø25/6 ATÜ BORU (H.FREE)(A.YAYAN)	100 mt.	30,57
001 165 506032 00 12	Ø32/6 ATÜ BORU (H.FREE)(A.YAYAN)	100 mt.	45,50
001 165 506037 00 12	Ø37/6 ATÜ BORU (H.FREE)(A.YAYAN)	100 mt.	67,08
001 165 506040 00 12	Ø40/6 ATÜ BORU (H.FREE)(A.YAYAN)	100 mt.	69,89
001 165 506050 00 12	Ø50/6 ATÜ BORU (H.FREE)(A.YAYAN)	100 mt.	114,74
001 165 506063 00 12	Ø63/6 ATÜ BORU (H.FREE)(A.YAYAN)	100 mt.	153,12
001 165 506075 00 12	Ø75/6 ATÜ BORU (H.FREE)(A.YAYAN)	100 mt.	206,88
001 165 506090 00 12	Ø90/6 ATÜ BORU (H.FREE)(A.YAYAN)	75 mt.	303,93
<b>MEKS SERİSİ TURUNCU BORULAR - HALOJEN FREE - ALEV YAYAN - 750N - 10 ATÜ</b>			
001 165 510014 00 12	Ø14/10 ATÜ BORU (H.FREE)(A.YAYAN)	100 mt.	16,47
001 165 510016 00 12	Ø16/10 ATÜ BORU (H.FREE)(A.YAYAN)	100 mt.	18,83
001 165 510018 00 12	Ø18/10 ATÜ BORU (H.FREE)(A.YAYAN)	100 mt.	21,82
001 165 510020 00 12	Ø20/10 ATÜ BORU (H.FREE)(A.YAYAN)	100 mt.	25,82
001 165 510025 00 12	Ø25/10 ATÜ BORU (H.FREE)(A.YAYAN)	100 mt.	32,63
001 165 510032 00 12	Ø32/10 ATÜ BORU (H.FREE)(A.YAYAN)	100 mt.	48,29
001 165 510037 00 12	Ø37/10 ATÜ BORU (H.FREE)(A.YAYAN)	100 mt.	76,42
001 165 510040 00 12	Ø40/10 ATÜ BORU (H.FREE)(A.YAYAN)	100 mt.	80,35
001 165 510050 00 12	Ø50/10 ATÜ BORU (H.FREE)(A.YAYAN)	100 mt.	131,56
001 165 510063 00 12	Ø63/10 ATÜ BORU (H.FREE)(A.YAYAN)	100 mt.	166,31
001 165 510075 00 12	Ø75/10 ATÜ BORU (H.FREE)(A.YAYAN)	100 mt.	238,27
001 165 510090 00 12	Ø90/10 ATÜ BORU (H.FREE)(A.YAYAN)	75 mt.	338,39
001 165 510100 00 12	Ø100/10 ATÜ BORU (H.FREE)(A.YAYAN)	75 mt.	412,91
001 165 510110 00 12	Ø110/10 ATÜ BORU (H.FREE)(A.YAYAN)	50 mt.	487,58
<b>MEKS SERİSİ TURUNCU BORULAR - HALOJEN FREE - ALEV YAYAN - 1250N</b>			
001 165 512020 00 12	20 Ø BORU (H.FREE)(A.YAYAN)	100 mt.	54,85
001 165 512025 00 12	25 Ø BORU (H.FREE)(A.YAYAN)	100 mt.	68,59
001 165 512032 00 12	32 Ø BORU (H.FREE)(A.YAYAN)	100 mt.	102,01
<b>MEKS SERİSİ TURUNCU BORULAR - HALOJEN FREE - ALEV YAYMAYAN - 320N - 6 ATÜ</b>			
001 165 106014 00 12	Ø14/6 ATÜ BORU (H.FREE)(A.YAYMAYAN)	100 mt.	22,58
001 165 106016 00 12	Ø16/6 ATÜ BORU (H.FREE)(A.YAYMAYAN)	100 mt.	26,65
001 165 106018 00 12	Ø18/6 ATÜ BORU (H.FREE)(A.YAYMAYAN)	100 mt.	30,95
001 165 106020 00 12	Ø20/6 ATÜ BORU (H.FREE)(A.YAYMAYAN)	100 mt.	34,95
001 165 106025 00 12	Ø25/6 ATÜ BORU (H.FREE)(A.YAYMAYAN)	100 mt.	46,80
001 165 106032 00 12	Ø32/6 ATÜ BORU (H.FREE)(A.YAYMAYAN)	100 mt.	68,79
001 165 106037 00 12	Ø37/6 ATÜ BORU (H.FREE)(A.YAYMAYAN)	100 mt.	100,85
001 165 106040 00 12	Ø40/6 ATÜ BORU (H.FREE)(A.YAYMAYAN)	100 mt.	115,32
001 165 106050 00 12	Ø50/6 ATÜ BORU (H.FREE)(A.YAYMAYAN)	100 mt.	168,73
001 165 106063 00 12	Ø63/6 ATÜ BORU (H.FREE)(A.YAYMAYAN)	100 mt.	227,20
001 165 106075 00 12	Ø75/6 ATÜ BORU (H.FREE)(A.YAYMAYAN)	100 mt.	299,49
001 165 106090 00 12	Ø90/6 ATÜ BORU (H.FREE)(A.YAYMAYAN)	75 mt.	461,22
<b>MEKS SERİSİ TURUNCU BORULAR - HALOJEN FREE - ALEV YAYMAYAN - 750N - 10 ATÜ</b>			
001 165 110014 00 12	Ø14/10 ATÜ BORU (H.FREE)(A.YAYMAYAN)	100 mt.	24,05
001 165 110016 00 12	Ø16/10 ATÜ BORU (H.FREE)(A.YAYMAYAN)	100 mt.	29,27
001 165 110018 00 12	Ø18/10 ATÜ BORU (H.FREE)(A.YAYMAYAN)	100 mt.	34,97
001 165 110020 00 12	Ø20/10 ATÜ BORU (H.FREE)(A.YAYMAYAN)	100 mt.	42,54
001 165 110025 00 12	Ø25/10 ATÜ BORU (H.FREE)(A.YAYMAYAN)	100 mt.	51,37
001 165 110032 00 12	Ø32/10 ATÜ BORU (H.FREE)(A.YAYMAYAN)	100 mt.	79,16
001 165 110037 00 12	Ø37/10 ATÜ BORU (H.FREE)(A.YAYMAYAN)	100 mt.	126,73
001 165 110040 00 12	Ø40/10 ATÜ BORU (H.FREE)(A.YAYMAYAN)	100 mt.	132,37
001 165 110050 00 12	Ø50/10 ATÜ BORU (H.FREE)(A.YAYMAYAN)	100 mt.	200,25
001 165 110063 00 12	Ø63/10 ATÜ BORU (H.FREE)(A.YAYMAYAN)	100 mt.	257,75
001 165 110075 00 12	Ø75/10 ATÜ BORU (H.FREE)(A.YAYMAYAN)	100 mt.	360,85
001 165 110090 00 12	Ø90/10 ATÜ BORU (H.FREE)(A.YAYMAYAN)	75 mt.	509,66
001 165 110100 00 12	Ø100/10 ATÜ BORU (H.FREE)(A.YAYMAYAN)	75 mt.	659,96
001 165 110110 00 12	Ø110/10 ATÜ BORU (H.FREE)(A.YAYMAYAN)	50 mt.	817,54



Ürün Kodu	Ürün Adı	Kutu Mt./Ad.	Koli Adet	Fiyat (₺)
-----------	----------	--------------	-----------	-----------

### MEKS SERİSİ BORULAR - HALOJEN FREE - ALEV YAYMAYAN - 1250N

001 165 112020 00 12	20 Ø BORU (H.FREE)(A.YAYMAYAN)	100 mt.		76,90
001 165 112025 00 12	25 Ø BORU (H.FREE)(A.YAYMAYAN)	100 mt.		98,38
001 165 112032 00 12	32 Ø BORU (H.FREE)(A.YAYMAYAN)	100 mt.		152,80

### MEKS SERİSİ TURUNCU BORU - HALOJEN FREE - ALEV YAYAN - TELLİ - 320N - 6 ATÜ

001 165 906014 00 12	Ø14/6 ATÜ BORU(H.FREE)(A.YAYAN)(TELLİ)(TURUNCU)	100 mt.		17,29
001 165 906016 00 12	Ø16/6 ATÜ BORU(H.FREE)(A.YAYAN)(TELLİ)(TURUNCU)	100 mt.		19,53
001 165 906018 00 12	Ø18/6 ATÜ BORU(H.FREE)(A.YAYAN)(TELLİ)(TURUNCU)	100 mt.		21,59
001 165 906020 00 12	Ø20/6 ATÜ BORU(H.FREE)(A.YAYAN)(TELLİ)(TURUNCU)	100 mt.		23,46
001 165 906025 00 12	Ø25/6 ATÜ BORU(H.FREE)(A.YAYAN)(TELLİ)(TURUNCU)	100 mt.		32,21
001 165 906032 00 12	Ø32/6 ATÜ BORU(H.FREE)(A.YAYAN)(TELLİ)(TURUNCU)	100 mt.		47,14
001 165 906037 00 12	Ø37/6 ATÜ BORU(H.FREE)(A.YAYAN)(TELLİ)(TURUNCU)	100 mt.		68,72
001 165 906040 00 12	Ø40/6 ATÜ BORU(H.FREE)(A.YAYAN)(TELLİ)(TURUNCU)	100 mt.		71,53

### MEKS SERİSİ TURUNCU BORU - HALOJEN FREE - ALEV YAYAN - TELLİ - 750N - 10 ATÜ

001 165 910014 00 12	Ø14/10 ATÜ BORU(H.FREE)(A.YAYAN)(TELLİ)(TURUNCU)	100 mt.		18,41
001 165 910016 00 12	Ø16/10 ATÜ BORU(H.FREE)(A.YAYAN)(TELLİ)(TURUNCU)	100 mt.		20,47
001 165 910018 00 12	Ø18/10 ATÜ BORU(H.FREE)(A.YAYAN)(TELLİ)(TURUNCU)	100 mt.		23,46
001 165 910020 00 12	Ø20/10 ATÜ BORU(H.FREE)(A.YAYAN)(TELLİ)(TURUNCU)	100 mt.		27,46
001 165 910025 00 12	Ø25/10 ATÜ BORU(H.FREE)(A.YAYAN)(TELLİ)(TURUNCU)	100 mt.		34,27
001 165 910032 00 12	Ø32/10 ATÜ BORU(H.FREE)(A.YAYAN)(TELLİ)(TURUNCU)	100 mt.		49,93
001 165 910037 00 12	Ø37/10 ATÜ BORU(H.FREE)(A.YAYAN)(TELLİ)(TURUNCU)	100 mt.		78,06
001 165 910040 00 12	Ø40/10 ATÜ BORU(H.FREE)(A.YAYAN)(TELLİ)(TURUNCU)	100 mt.		81,99

### MEKS SERİSİ BORULAR - HALOJEN FREE - ALEV YAYMAYAN - TELLİ - 320N - 6 ATÜ

001 165 306014 00 12	Ø14/6 ATÜ BORU(H.FREE)(A.YAYMAYAN)(TELLİ)(TURUNCU)	100 mt.		24,22
001 165 306016 00 12	Ø16/6 ATÜ BORU(H.FREE)(A.YAYMAYAN)(TELLİ)(TURUNCU)	100 mt.		28,29
001 165 306018 00 12	Ø18/6 ATÜ BORU(H.FREE)(A.YAYMAYAN)(TELLİ)(TURUNCU)	100 mt.		32,59
001 165 306020 00 12	Ø20/6 ATÜ BORU(H.FREE)(A.YAYMAYAN)(TELLİ)(TURUNCU)	100 mt.		36,59
001 165 306025 00 12	Ø25/6 ATÜ BORU(H.FREE)(A.YAYMAYAN)(TELLİ)(TURUNCU)	100 mt.		48,44
001 165 306032 00 12	Ø32/6 ATÜ BORU(H.FREE)(A.YAYMAYAN)(TELLİ)(TURUNCU)	100 mt.		70,43
001 165 306037 00 12	Ø37/6 ATÜ BORU(H.FREE)(A.YAYMAYAN)(TELLİ)(TURUNCU)	100 mt.		102,49
001 165 306040 00 12	Ø40/6 ATÜ BORU(H.FREE)(A.YAYMAYAN)(TELLİ)(TURUNCU)	100 mt.		116,96

### MEKS SERİSİ BORULAR - HALOJEN FREE - ALEV YAYMAYAN - TELLİ - 750N - 10 ATÜ

001 165 310014 00 12	Ø14/10 ATÜ BORU(H.FREE)(A.YAYMAYAN)(TELLİ)(TURUNCU)	100 mt.		25,69
001 165 310016 00 12	Ø16/10 ATÜ BORU(H.FREE)(A.YAYMAYAN)(TELLİ)(TURUNCU)	100 mt.		30,90
001 165 310018 00 12	Ø18/10 ATÜ BORU(H.FREE)(A.YAYMAYAN)(TELLİ)(TURUNCU)	100 mt.		36,61
001 165 310020 00 12	Ø20/10 ATÜ BORU(H.FREE)(A.YAYMAYAN)(TELLİ)(TURUNCU)	100 mt.		44,18
001 165 310025 00 12	Ø25/10 ATÜ BORU(H.FREE)(A.YAYMAYAN)(TELLİ)(TURUNCU)	100 mt.		53,01
001 165 310032 00 12	Ø32/10 ATÜ BORU(H.FREE)(A.YAYMAYAN)(TELLİ)(TURUNCU)	100 mt.		80,80
001 165 310037 00 12	Ø37/10 ATÜ BORU(H.FREE)(A.YAYMAYAN)(TELLİ)(TURUNCU)	100 mt.		128,37
001 165 310040 00 12	Ø40/10 ATÜ BORU(H.FREE)(A.YAYMAYAN)(TELLİ)(TURUNCU)	100 mt.		134,01

### PLASTİK BORULAR

001 045 000014 30 00	14 MM KALIN BOY BORU	102 mt.	510 mt.	13,89
001 045 000018 30 00	18 MM KALIN BOY BORU	102 mt.	510 mt.	16,50
001 045 000026 30 00	26 MM KALIN BOY BORU	51 mt.	255 mt.	28,23
001 045 000037 30 00	37 MM KALIN BOY BORU	30 mt.		52,36
001 045 010014 00 11	14 MM KANGAL (NORMAL)	100 mt.		13,89
001 045 010018 00 11	18 MM KANGAL (NORMAL)	100 mt.		16,50
001 045 010026 00 11	26 MM KANGAL (NORMAL)	50 mt.		28,23
001 045 010037 00 11	37 MM KANGAL (NORMAL)	50 mt.		63,95
001 045 020014 00 00	14 MM KANGAL (KAUÇUK)	100 mt.		14,01
001 045 020018 00 00	18 MM KANGAL (KAUÇUK)	100 mt.		16,87
001 045 020026 00 00	26 MM KANGAL (KAUÇUK)	50 mt.		28,61
001 045 020037 00 00	37 MM KANGAL (KAUÇUK)	50 mt.		53,08
001 045 030014 00 00	14 MM KANGAL (KAUÇUK) (KALIN)	100 mt.		15,85
001 045 030018 00 00	18 MM KANGAL (KAUÇUK) (KALIN)	100 mt.		17,79

### PLASTİK DİRSEK VE MUFLAR

127 051 000014	PLASTİK 14 Ø DİRSEK	100 ad.	2000	5,19
127 051 000018	PLASTİK 18 Ø DİRSEK	100 ad.	1000	6,48
127 051 000026	PLASTİK 26 Ø DİRSEK	100 ad.	500	11,48
001 051 020014 00 11	PLASTİK 14 Ø MUF		1500	5,58
001 051 020018 00 11	PLASTİK 18 Ø MUF		1000	9,83
001 051 020026 00 11	PLASTİK 26 Ø MUF		500	9,87
001 051 020037 00 11	PLASTİK 37 Ø MUF		250	19,93

### POLİETİLEN SİYAH YERALTI BORULAR - 450N

001 165 406014 00 11	14/6 ATÜ POLİETİLEN BORU (SİYAH)	100 mt.		15,50
001 165 406016 00 11	16/6 ATÜ POLİETİLEN BORU (SİYAH)	100 mt.		17,71
001 165 406018 00 11	18/6 ATÜ POLİETİLEN BORU (SİYAH)	100 mt.		19,74
001 165 406020 00 11	20/6 ATÜ POLİETİLEN BORU (SİYAH)	100 mt.		21,60
001 165 406025 00 11	25/6 ATÜ POLİETİLEN BORU (SİYAH)	100 mt.		30,24
001 165 406032 00 11	32/6 ATÜ POLİETİLEN BORU (SİYAH)	100 mt.		45,00
001 165 406037 00 11	37/6 ATÜ POLİETİLEN BORU (SİYAH)	100 mt.		66,37
001 165 406040 00 11	40/6 ATÜ POLİETİLEN BORU (SİYAH)	100 mt.		69,93
001 165 406050 00 11	50/6 ATÜ POLİETİLEN BORU (SİYAH)	100 mt.		113,63
001 165 406063 00 11	63/6 ATÜ POLİETİLEN BORU (SİYAH)	100 mt.		151,57
001 165 406075 00 11	75/6 ATÜ POLİETİLEN BORU (SİYAH)	100 mt.		204,75
001 165 406090 00 11	90/6 ATÜ POLİETİLEN BORU (SİYAH)	75 mt.		300,75

### POLİETİLEN SİYAH YER ALTI BORULAR - 750N

001 165 410014 00 11	14/10 ATÜ POLİETİLEN BORU (SİYAH)	100 mt.		16,61
001 165 410016 00 11	16/10 ATÜ POLİETİLEN BORU (SİYAH)	100 mt.		18,62
001 165 410018 00 11	18/10 ATÜ POLİETİLEN BORU (SİYAH)	100 mt.		21,58
001 165 410020 00 11	20/10 ATÜ POLİETİLEN BORU (SİYAH)	100 mt.		25,25
001 165 410025 00 11	25/10 ATÜ POLİETİLEN BORU (SİYAH)	100 mt.		32,24
001 165 410032 00 11	32/10 ATÜ POLİETİLEN BORU (SİYAH)	100 mt.		49,07
001 165 410037 00 11	37/10 ATÜ POLİETİLEN BORU (SİYAH)	100 mt.		71,98
001 165 410040 00 11	40/10 ATÜ POLİETİLEN BORU (SİYAH)	100 mt.		72,00
001 165 410050 00 11	50/10 ATÜ POLİETİLEN BORU (SİYAH)	100 mt.		130,03
001 165 410063 00 11	63/10 ATÜ POLİETİLEN BORU (SİYAH)	100 mt.		164,40
001 165 410075 00 11	75/10 ATÜ POLİETİLEN BORU (SİYAH)	100 mt.		235,64
001 165 410090 00 11	90/10 ATÜ POLİETİLEN BORU (SİYAH)	75 mt.		334,98
001 165 410100 00 11	100/10 ATÜ POLİETİLEN BORU (SİYAH)	75 mt.		408,57
001 165 410110 00 11	110/10 ATÜ POLİETİLEN BORU (SİYAH)	50 mt.		482,19

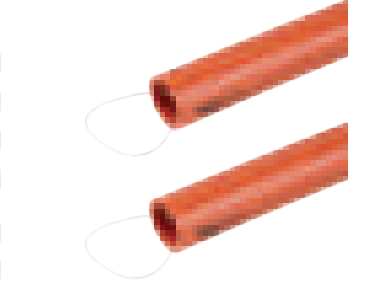

001 046 130107 00 11 001 046 170102 00 11



001 046 130101 00 11 001 046 170101 00 11

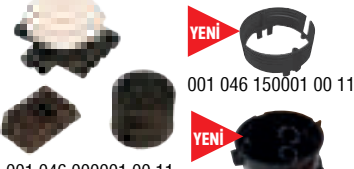

001 046 000001 00 11 001 046 130102 00 11



001 046 130201 00 12 001 046 160201 00 12



001 046 180101 00 12 001 046 120110 00 12

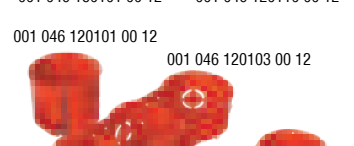

001 046 120101 00 12 001 046 120103 00 12



001 046 120100 00 12 001 046 120100 00 12

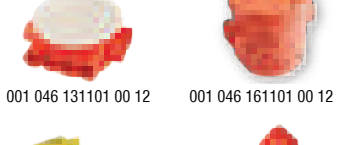

001 046 131101 00 12 001 046 161101 00 12

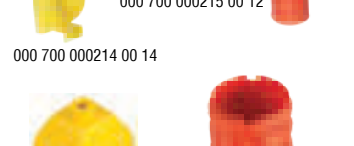

000 700 000215 00 12 000 700 000214 00 14



000 700 000036 00 14 000 700 000035 00 12

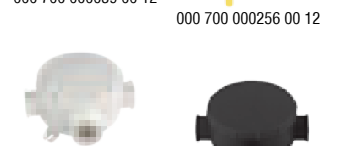

000 700 000039 00 12 000 700 000256 00 12



001 046 000103 00 00 001 046 000103 00 11

Ürün Kodu	Ürün Adı	Kutu Mt./Ad.	Koli Adet	Fiyat (₺)
-----------	----------	--------------	-----------	-----------

### PLASTİK KASA - BUAT - TAKOZLAR

001 046 130102 00 11	NORM KASA	100 ad.	1000	5,56
001 046 130101 00 11	NORM BUAT (14-18 ÇIKIŞLI)	50 ad.	500	12,78
001 046 130105 00 11	NORM BUAT KAPAKSIZ	50 ad.	500	9,63
001 046 160102 00 11	GEÇMELİ PLASTİK KASA	100 ad.	400	16,89
001 046 160101 00 11	GEÇMELİ DERİN KASA	100 ad.	500	11,11
001 046 130107 00 11	GEÇMELİ DERİN KASA KAPAKSIZ	100 ad.	500	8,33
001 046 180101 00 11	ÇİFT KİLİTLEMELİ GEÇMELİ DERİN KASA SİYAH	75 ad.	300	34,10
001 046 150000 00 11	GEÇMELİ DERİN KASA UZATMA PARÇASI SİYAH	225 ad.	900	16,02
001 046 120110 00 11	GEÇMELİ ALÇIPAN KASA (KOLAY BAĞLANTILI) SİYAH	60 ad.	240	26,48
001 046 120101 00 11	ALÇIPAN KASA 1'Lİ	75 ad.	300	31,75
001 046 120102 00 11	ALÇIPAN KASA 2'Lİ	50 ad.	200	46,64
001 046 120103 00 11	ALÇIPAN KASA 3'Lİ	25 ad.	100	67,08
001 046 120100 00 11	GEÇMELİ ALÇ.KASA SİYAH	50 ad.	300	17,59
001 046 170101 00 11	TÜNEL KASA	100 ad.	500	37,60
001 046 170102 00 11	TÜNEL BUAT	50 ad.	300	24,06
001 046 000001 00 11	PLASTİK TAKOZ (14-18 ÇIKIŞLI)	100 ad.	1000	9,26

### TURUNCU KASA VE BUATLAR - HALOJEN FREE - ALEV YAYAN

001 046 130202 00 12	NORM KASA (TURUNCU) (H.FREE) (ALEV YAYAN)	100 ad.	1000	10,97
001 046 130201 00 12	NORM BUAT (TURUNCU) (H.FREE) (ALEV YAYAN)	50 ad.	500	18,52
001 046 160201 00 12	GEÇMELİ DERİN KASA (TURUNCU) (H.FREE) (ALEV YAYAN)	100 ad.	500	20,23

### TURUNCU KASA VE BUATLAR - ALEV YAYAN

001 046 130102 00 12	NORM KASA (TURUNCU)(ALEV YAYAN)	100 ad.	1000	8,03
001 046 130101 00 12	NORM BUAT (TURUNCU)(ALEV YAYAN)	50 ad.	500	16,07
001 046 170101 00 12	TÜNEL KASA (TURUNCU)(ALEV YAYAN)	100 ad.	500	30,25
001 046 170102 00 12	TÜNEL BUAT (TURUNCU)(ALEV YAYAN)	50 ad.	300	22,82
001 046 160102 00 12	GEÇMELİ PLASTİK KASA (TURUNCU)(ALEV YAYAN)	100 ad.	400	18,56
001 046 160101 00 12	GEÇMELİ DERİN KASA (TURUNCU)(ALEV YAYAN)	100 ad.	500	18,52
001 046 180101 00 12	ÇİFT KİLİTLEMELİ GEÇMELİ DERİN KASA TURUNCU	75 ad.	300	34,10
001 046 150000 00 12	GEÇMELİ DERİN KASA UZATMA PARÇASI TURUNCU	225 ad.	900	16,02
001 046 120110 00 12	GEÇMELİ ALÇIPAN KASA (KOLAY BAĞLANTILI) TURUNCU	60 ad.	240	26,48
001 046 120101 00 12	ALÇIPAN KASA 1'Lİ (TURUNCU)(ALEV YAYAN)	75 ad.	300	33,28
001 046 120102 00 12	ALÇIPAN KASA 2'Lİ (TURUNCU)(ALEV YAYAN)	50 ad.	200	49,34
001 046 120103 00 12	ALÇIPAN KASA 3'LÜ (TURUNCU)(ALEV YAYAN)	25 ad.	100	70,57
001 046 120100 00 12	GEÇMELİ ALÇIPAN KASA (TURUNCU)(ALEV YAYAN)	50 ad.	300	22,34

### TURUNCU KASA VE BUATLAR - ALEV YAYMAYAN

001 046 131102 00 12	NORM KASA (TURUNCU)(ALEV YAYMAYAN)	100 ad.	1000	10,74
001 046 131101 00 12	NORM BUAT (TURUNCU)(ALEV YAYMAYAN)	50 ad.	500	20,74
001 046 161102 00 12	GEÇMELİ PLASTİK KASA (TURUNCU)(ALEV YAYMAYAN)	100 ad.	400	27,78
001 046 161101 00 12	GEÇMELİ DERİN KASA (TURUNCU)(ALEV YAYMAYAN)	100 ad.	500	24,07
001 046 181101 00 12	ÇİFT KİLİTLEMELİ GEÇMELİ DERİN KASA TURUNCU	75 ad.	300	40,95
001 046 181201 00 12	ÇİFT KİLİT. GEÇ. DERİN KASA TURUNCU A.YAYMAYAN (H.FREE)	75 ad.	300	49,15
001 046 150001 00 12	GEÇMELİ DERİN KASA UZATMA PARÇASI TURUNCU	225 ad.	900	16,02
001 046 210002 00 12	TÜNEL KASA (TURUNCU)(ALEV YAYMAYAN)	100 ad.	500	45,56
001 046 210003 00 12	TÜNEL BUAT (TURUNCU)(ALEV YAYMAYAN)	50 ad.	300	37,04
001 046 121101 00 12	ALÇIPAN KASA 1'Lİ (TURUNCU)(ALEV YAYMAYAN)	75 ad.	300	40,74
001 046 121102 00 12	ALÇIPAN KASA 2'Lİ (TURUNCU)(ALEV YAYMAYAN)	50 ad.	200	59,26
001 046 121103 00 12	ALÇIPAN KASA 3'LÜ (TURUNCU)(ALEV YAYMAYAN)	25 ad.	100	81,48
001 046 121100 00 12	GEÇMELİ ALÇIPAN KASA (TURUNCU)(ALEV YAYMAYAN)	50 ad.	300	26,30

### BETON DUVAR ANAHTAR KASALARI - ALEV YAYAN

000 700 000037 00 14	BUAT ARKA KAPAK SARI (ALEV YAYAN)	50 ad.	500	6,68
000 700 000035 00 12	BUAT GÖVDE 60'LİK TURUNCU (ALEV YAYAN)	50 ad.	350	14,37
000 700 000256 00 14	KALIBA TESPİT ELEMANI SARI (ALEV YAYAN)		250	9,06
000 700 000039 00 12	SIĞ BRÜT ANAH. KASASI TURUNCU (ALEV YAYAN)	100 ad.	500	25,56
000 700 000036 00 14	KONİK GÖVDE SARI (ALEV YAYAN)	50 ad.	250	13,37
000 700 000214 00 14	APLİK 20'LİK SARI (ALEV YAYAN)	100 ad.	1000	7,14
000 700 000215 00 12	APLİK EĞİK BAĞLANTI DIRSEĞİ TURUNCU (ALEV YAYAN)	100 ad.	1000	6,87

### BETON DUVAR ANAHTAR KASALARI - ALEV YAYMAYAN

000 700 200037 00 14	BUAT ARKA KAPAK SARI (ALEV YAYMAYAN)	50 ad.	500	8,69
000 700 200035 00 12	BUAT GÖVDE 60'LİK TURUNCU (ALEV YAYMAYAN)	50 ad.	350	17,96
000 700 200256 00 14	KALIBA TESPİT ELEMANI SARI (ALEV YAYMAYAN)		250	12,23
000 700 200039 00 12	SIĞ BRÜT ANAH. KASASI TURUNCU (ALEV YAYMAYAN)	100 ad.	500	40,33
000 700 200036 00 14	KONİK GÖVDE SARI (ALEV YAYMAYAN)	50 ad.	250	18,83
000 700 200214 00 14	APLİK 20'LİK SARI (ALEV YAYMAYAN)	100 ad.	1000	8,89
000 700 200215 00 12	APLİK EĞİK BAĞLANTI DIRSEĞİ TURUNCU (ALEV YAYMAYAN)	100 ad.	1000	10,72

Ürün Kodu	Ürün Adı	Kutu Mt./Ad.	Koli Adet	Fiyat (₺)
<b>KARE BUAT</b>				
001 046 021010 00 11	10X10 KARE BUAT (SİYAH)	10 ad.	300	106,58
001 046 021212 00 11	12X12 KARE BUAT (SİYAH)	10 ad.	200	111,94
001 046 021515 00 11	15X15 KARE BUAT (SİYAH)	10 ad.	120	152,66
001 046 022020 00 11	20X20 KARE BUAT (SİYAH)	10 ad.	70	181,58
001 046 000103 00 11	ANTİGRON BUAT 3'LÜ PLASTİK (SİYAH)	10 ad.	240	75,29
001 046 000104 00 11	ANTİGRON BUAT 4'LÜ PLASTİK (SİYAH)	10 ad.	240	88,60
001 046 000103 00 00	ANTİGRON BUAT 3'LÜ PLASTİK (BEYAZ)	10 ad.	240	75,30
001 046 000104 00 00	ANTİGRON BUAT 4'LÜ PLASTİK (BEYAZ)	10 ad.	240	88,59
001 046 021010 00 12	10X10 KARE BUAT TURUNCU	10 ad.	300	111,91
001 046 021212 00 12	12X12 KARE BUAT TURUNCU	10 ad.	200	117,53
001 046 021515 00 12	15X15 KARE BUAT TURUNCU	10 ad.	120	160,30
001 046 022020 00 12	20X20 KARE BUAT TURUNCU	10 ad.	70	190,66
001 046 000103 00 12	ANTİGRON BUAT 3'LÜ TURUNCU	10 ad.	240	79,06
001 046 000104 00 12	ANTİGRON BUAT 4'LÜ TURUNCU	10 ad.	240	93,02



001 046 021212 00 11



001 046 021212 00 12

<b>TURUNCU KARE BUAT - ALEV YAYMAYAN</b>				
001 046 051010 00 12	KARE BUAT TURUNCU(10X10) (A.YAYMAYAN)	10 ad.	300	123,10
001 046 051212 00 12	KARE BUAT TURUNCU(12X12) (A.YAYMAYAN)	10 ad.	200	129,29
001 046 051515 00 12	KARE BUAT TURUNCU(15X15) (A.YAYMAYAN)	10 ad.	120	176,32
001 046 052020 00 12	KARE BUAT TURUNCU(20X20) (A.YAYMAYAN)	10 ad.	70	209,72

<b>LÜKS BUAT KAPAKLARI</b>				
126 046 180001	LÜKS BUAT KAPAĞI(BOMBELİ-PLS. AYAK)	100 ad.	1000	7,41
126 046 180003	LÜKS BUAT KAPAĞI(DÜZ PLS. AYAK)	100 ad.	1000	7,41
126 046 180004	LÜKS BUAT KAPAĞI(BOMB.PLS.AYAK)VİDALI	100 ad.	1000	22,22

<b>KARE BUAT KAPAKLARI</b>				
000 700 000043 00 00	10X10 KARE BUAT KAPAĞI	1 ad.	300	20,86
000 700 000045 00 00	12X12 KARE BUAT KAPAĞI	1 ad.	350	24,33
000 700 000047 00 00	15X15 KARE BUAT KAPAĞI	1 ad.	260	35,30
000 700 000049 00 00	20X20 KARE BUAT KAPAĞI	1 ad.	140	59,42

Ürün Kodu	Ürün Adı	Kutu Mt./Ad.	Koli Adet	Fiyat (₺)
-----------	----------	--------------	-----------	-----------

<b>GALVANİZLİ SAC KROŞELER</b>				
001 048 060001 00 00	NO. 1 TEKLİ GALVANİZ SAC KROŞE 12MM	1500 ad.		3,50
001 048 060002 00 00	NO. 2 TEKLİ GALVANİZ SAC KROŞE 14MM	1000 ad.		3,63
001 048 060003 00 00	NO. 3 TEKLİ GALVANİZ SAC KROŞE 17MM	700 ad.		3,87
001 048 060004 00 00	NO. 4 TEKLİ GALVANİZ SAC KROŞE 20MM	500 ad.		4,21
001 048 060007 00 00	NO. 7 TEKLİ GALVANİZ SAC KROŞE 26MM	350 ad.		5,14
001 048 060008 00 00	NO. 8 TEKLİ GALVANİZ SAC KROŞE 34MM	250 ad.		13,75
001 048 060009 00 00	NO. 9 TEKLİ GALVANİZ SAC KROŞE 43MM	200 ad.		15,60
001 048 060010 00 00	NO. 10 TEKLİ GALVANİZ SAC KROŞE 53MM	150 ad.		16,65
001 048 060011 00 00	NO. 11 TEKLİ GALVANİZ SAC KROŞE 55MM	120 ad.		18,56
001 048 070002 00 00	NO. 2 ÇİFTLİ GALVANİZ SAC KROŞE 13MM	600 ad.		3,89
001 048 070003 00 00	NO. 3 ÇİFTLİ GALVANİZ SAC KROŞE 16MM	500 ad.		4,48
001 048 070004 00 00	NO. 4 ÇİFTLİ GALVANİZ SAC KROŞE 22MM	400 ad.		4,54
001 048 070007 00 00	NO. 7 ÇİFTLİ GALVANİZ SAC KROŞE 25MM	400 ad.		5,35
001 048 070008 00 00	NO. 8 ÇİFTLİ GALVANİZ SAC KROŞE 35MM	300 ad.		12,96
001 048 070009 00 00	NO. 9 ÇİFTLİ GALVANİZ SAC KROŞE 45MM	200 ad.		15,46
001 048 070010 00 00	NO. 10 ÇİFTLİ GALVANİZ SAC KROŞE 50MM	150 ad.		16,35
001 048 070011 00 00	NO. 11 ÇİFTLİ GALVANİZ SAC KROŞE 55MM	100 ad.		17,72



126 046 180001

126 046 180004



000 700 000047 00 00

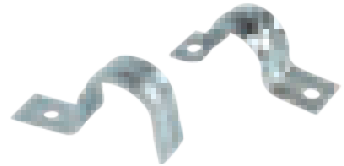



Ürün Kodu	Ürün Adı	Kutu Mt./Ad.	Koli Adet	Fiyat (₺)
<b>MUTLUSAN BETON ÇİVİLİ KROŞELER</b>				
032 048 070000	NO:0 BETON ÇİVİLİ KROŞE(0.75 YASSIKORD.)	1000 ad.	20000	0,56
032 048 070001	NO:1 BETON ÇİVİLİ KROŞE(0.75 YASSIKORD.)	1000 ad.	20000	0,65
032 048 070002	NO:2 BETON ÇİVİLİ KROŞE(0.75 YASSIKORD.)	1000 ad.	20000	0,65
032 048 070003	NO:3 BETON ÇİVİLİ KROŞE (2X1.5-3X1.5)	1000 ad.	20000	0,85
032 048 070004	NO:4 BETON ÇİVİLİ KROŞE (2X4)	1000 ad.	20000	0,93
032 048 070005	NO:5 BETON ÇİVİLİ KROŞE (2X4-4X4)	1000 ad.	10000	1,19
032 048 070006	NO:6 BETON ÇİVİLİ KROŞE (2X6)	1000 ad.	10000	1,44
032 048 070007	NO:7 BETON ÇİVİLİ KROŞE (4X10)	1000 ad.	5000	2,41
032 048 070008	NO:8 BETON ÇİVİLİ KROŞE (3X16+10)	800 ad.	3200	3,33



001 053 000001 00 00



016 053 00000X

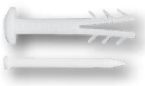

001 053 000002 00 00



016 053 000014

### RAY KROŞE VE TANDIR KROŞELER

035 048 100001	NO. 1 RAY KROŞE (2X1.5-4X2.5)	350 ad.		12,29
035 048 100002	NO. 2 RAY KROŞE (4X4-4X16)	250 ad.		13,52
001 025 010100 00 00	GALVANİZ KROŞE RAYI (1M)	50 ad.		100,37
035 048 110001	NO. 1 TANDIR KROŞE (2X1.5-2X6)	350 ad.		12,29
035 048 110002	NO. 2 TANDIR KROŞE (4X6)	250 ad.		12,29
035 048 110003	NO. 3 TANDIR KROŞE (4X10)	250 ad.		12,29
035 048 110004	NO. 4 TANDIR KROŞE (4X16)	150 ad.		15,98
035 048 110005	NO. 5 TANDIR KROŞE (3X25+16)	150 ad.		15,98

### PLASTİK DÜBELLER

016 053 000014	BURGULU ALÇIPAN DÜBELİ (YENİ)	100 ad.	10000	1,30
001 053 000001 00 00	ALÇIPAN DÜBEL	100 ad.	15000	0,93
001 053 000002 00 00	KANAL DÜBELİ	1000 ad.	14000	0,74
016 053 000006	6 MM BEYAZ DÜBEL	1000 ad.	35000	0,33
016 053 000007	7 MM BEYAZ DÜBEL	1000 ad.	25000	0,37
016 053 000008	8 MM BEYAZ DÜBEL	1000 ad.	20000	0,41

### DÜBELLİ KROŞELER

001 048 090002 00 17	3/13 TEKLİ KABLO KROŞESİ	500 ad.	10000	1,15
001 048 090006 00 17	8/28 TEKLİ KABLO KROŞESİ	500 ad.	5000	1,56
001 048 090001 00 00	ÇİFTLİ KABLO KROŞESİ (20'LİK)	100 ad.	8000	1,67
001 048 090002 00 00	ÇİFTLİ KABLO KROŞESİ (25'LİK)	250 ad.	5000	1,76
001 048 090003 00 17	16'LİK BORU KELEPÇESİ	100 ad.	2000	1,64
001 048 090004 00 17	20'LİK BORU KELEPÇESİ	100 ad.	1500	2,18
001 048 090005 00 17	25'LİK BORU KELEPÇESİ	100 ad.	1000	2,78



# Sizin Güvenliğiniz; Bizim Önceliğimiz!



## ELEKTRİK İZOLASYON BANTLARI 0.13mm x 19mm x 10yds (9,14m)

Ürün Kodu	Ürün Adı	Paket Ad.	Koli Ad.	Fiyat (₺)
065 133 001019	PVC ELEKTRİK İZOLE BANDI - SİYAH	10	500	28,00
065 133 011019	PVC ELEKTRİK İZOLE BANDI - BEYAZ	10	500	28,00
065 133 161019	PVC ELEKTRİK İZOLE BANDI - KIRMIZI	10	500	28,00
065 133 131019	PVC ELEKTRİK İZOLE BANDI - MAVİ	10	500	28,00
065 133 141019	PVC ELEKTRİK İZOLE BANDI - SARI	10	500	28,00
065 133 151019	PVC ELEKTRİK İZOLE BANDI - YEŞİL	10	500	28,00
065 133 171019	PVC ELEKTRİK İZOLE BANDI - SARI + YEŞİL	10	500	30,00

# Evinizin ritmi, kapınızda başlasın!

## KAPI ZİLLERİ



- 32 Farklı Seçilebilir Melodi
- Pil ile Çalışan Dekoratif Kablosuz Kapı Zili
- Algılama Mesafesi: Açık Alanda 100 Mt.
- Diğer Kablosuz Aygıtlarla Karışmayı Önlemek İçin Frekans Filtresi Kodu
- IP44 Led Işıklı, Etiketli Zil Butonu
- Zil Butonu İçin 1x1.2V 23A Pil
- İç Ünite İçin 3x1.5V AA Pil

\* WA-628 ve WA-638 modellerinin özellikleridir.



ÜRÜN KODU	888 038 218000
ÜRÜN ADI	Q218 KABLOSUZ KAPI ZİLİ LEDLİ 100 MT. - 32 MELODİ
AMB. AD./KOLİ	1 Ad. / 10
FİYAT	42,63 \$



ÜRÜN KODU	018 105 158100
ÜRÜN ADI	X-581 KAPI ZİLİ - 32 MELODİ
AMB. AD./KOLİ	1 Ad. / 10
FİYAT	28,26 \$



ÜRÜN KODU	018 105 114800
ÜRÜN ADI	A-148 KAPI ZİLİ - 32 MELODİ
AMB. AD./KOLİ	1 Ad. / 10
FİYAT	27,33 \$



ÜRÜN KODU	018 105 162800
ÜRÜN ADI	WA-628 KAPI ZİLİ BEYAZ 32 MELODİ
AMB. AD./KOLİ	1 Ad. / 10
FİYAT	36,01 \$



ÜRÜN KODU	018 105 162811
ÜRÜN ADI	WA-628 KAPI ZİLİ - SİYAH 32 MELODİ
AMB. AD./KOLİ	1/10
FİYAT	36,01 \$



ÜRÜN KODU	018 105 163800
ÜRÜN ADI	WA-638 KAPI ZİLİ BEYAZ 32 MELODİ
AMB. AD./KOLİ	1 Ad. / 10
FİYAT	36,02 \$



ÜRÜN KODU	018 105 163811
ÜRÜN ADI	WA-638 KAPI ZİLİ - SİYAH 32 MELODİ
AMB. AD./KOLİ	1 Ad. / 10
FİYAT	36,02 \$

Ürün Kodu	Ürün Adı	Kutu Mt./Ad.	Koli Adet	Fiyat (₺)
-----------	----------	--------------	-----------	-----------

### ZİL BUTONU ÇEŞİTLERİ

037 106 020001	1'Lİ ALÜMİNYUM ZİL BUTONU 1.KALİTE	1 ad.	100	111,11
037 106 020002	2'Lİ ALÜMİNYUM ZİL BUTONU 1.KALİTE	1 ad.	66	222,22
037 106 020003	3'LÜ ALÜMİNYUM ZİL BUTONU 1.KALİTE	1 ad.	56	333,33
037 106 020004	4'LÜ ALÜMİNYUM ZİL BUTONU 1.KALİTE	1 ad.	43	444,44
037 106 020005	5'Lİ ALÜMİNYUM ZİL BUTONU 1.KALİTE	1 ad.	36	555,56
037 106 020006	6'Lİ ALÜMİNYUM ZİL BUTONU 1.KALİTE	1 ad.	32	666,67
037 106 020007	7'Lİ ALÜMİNYUM ZİL BUTONU 1.KALİTE	1 ad.	28	777,78
037 106 020008	8'Lİ ALÜMİNYUM ZİL BUTONU 1.KALİTE	1 ad.	20	888,89
037 106 020009	9'LU ALÜMİNYUM ZİL BUTONU 1.KALİTE	1 ad.	20	1.000,00
037 106 020010	10'LU ALÜMİNYUM ZİL BUTONU 1.KALİTE	1 ad.	20	1.111,11



037 106 020003



037 106 020001

### ZİLLER VE ZİL TRAFOLARI

027 105 010012	ZİL TRAFOSU 12 V	1 ad.	80	351,85
027 105 010015	ZİL TRAFOSU 15 V	1 ad.	40	629,63
028 105 020003	KAMPANA ZİL 220 V	1 ad.	24	1.629,63
028 105 020004	KAMPANA ZİL 12V, 24V, 110V	1 ad.	24	2.407,41
028 105 020000	MUNZAM ZİL ROLESİ	1 ad.	100	1.111,11
018 105 000006	KANARYA ZİL (TEK SES)	1 ad.	50	185,19
018 105 000007	KANARYA ZİL (ÜÇ SES)	1 ad.	50	211,11
018 105 000001	TELEFON ZİLİ (AYARLI)	1 ad.	50	333,33
018 105 000002	DİNG DONG ZİL ELEKTRONİK (3 SES)	1 ad.	50	240,74



028 105 020003



018 105 000007



027 105 010012



Ürün Kodu	Ürün Adı	Kutu Mt./Ad.	Koli Adet	Fiyat (₺)
<b>AKILLI KAPI KİLİDİ</b>				
027 112 000010	AKILLI KAPI KİLİDİ	1 ad.		4.351,85
027 112 000012	KAPI KONTROL SİSTEMİ 1000 HAFIZALI KARTLI METAL GÖVDE	1 ad.		3.148,15
<b>KAPI VE MERDİVEN OTOMATIĞI</b>				
027 112 000001	GİZLİ KAPI OTOMATIĞI (DOKUNMATİK)	1 ad.	20	1.277,78
027 112 000002	GİZLİ KAPI OTOMATIĞI (BASMATİK)	1 ad.	20	1.277,78
027 112 000007	ELEK. KİLİTLİ (ANAHTARLI) KAPI OTOMATIĞI	1 ad.	12	2.351,85
027 112 000009	ELEKTRİKLİ KİLİTLİ KAPI OTOMATIĞI ( BİLYELİ )	1 ad.	12	2.351,85
027 112 000003	BUTONLU KAPI OTOMATIĞI	1 ad.	30	981,48
028 112 000004	KAPI OTOMATIĞI (NORMAL)	1 ad.	30	962,96
027 112 000004	BAS-AÇ KAPI OTOMATIĞI (TIRAJLI KİLİT İÇİN)	1 ad.		1.500,00
027 112 000005	MERDİVEN OTOMATIĞI (RAYLI)	1 ad.	30	944,44
027 112 000006	MERDİVEN OTOMATIĞI (NORMAL)	1 ad.	30	944,44
<b>TELEFON DAĞITIM KUTULARI ve AKSESUARLARI</b>				
001 049 001020 00 17	TLF. DĞT. KUTUSU (10 - 20) BOŞ PLS. KLT	2 ad.	60	449,81
001 049 201020 00 17	TLF.DĞT.KUTUSU(10-20)BOŞ PLS.(KİLİTLİ) (A. YAYMAYAN)	2 ad.	60	541,23
001 049 011020 00 17	TLF. DĞT. KUTUSU (10 - 20) BOŞ KİLİTLİ	2 ad.	60	523,94
001 049 211020 00 17	TLF.DĞT.KUTUSU(10-20)BOŞ(KİLİTLİ) (A. YAYMAYAN)	2 ad.	60	627,31
001 049 001050 00 17	TLF. DĞT. KUTUSU(10-50) BOŞ PLS.KİLİT	1 ad.	28	642,27
001 049 201050 00 17	TLF.DĞT.KUTUSU(10-50)BOŞ PLS.(KİLİTLİ) (A. YAYMAYAN)	1 ad.	28	892,38
001 049 011050 00 17	TLF. DĞT. KUTUSU(10-50) KİLİTLİ	1 ad.	28	716,40
001 049 211050 00 17	TLF.DĞT.KUTUSU(10-50)(KİLİTLİ) (A. YAYMAYAN)	1 ad.	28	886,97
001 024 000001 00 00	ÇATI (1 MODÜL İÇİN)	1 ad.	1000	29,63
001 024 000002 00 00	ÇATI (2 MODÜL İÇİN)	1 ad.	500	55,56
001 024 000003 00 00	ÇATI (3 MODÜL İÇİN)	1 ad.	400	92,59
001 024 000004 00 00	ÇATI (4 MODÜL İÇİN)	1 ad.	300	111,11
001 024 000005 00 00	ÇATI (5 MODÜL İÇİN)	1 ad.	200	148,15
001 024 000010 00 00	ÇATI (10 MODÜL İÇİN)	1 ad.	100	277,78
888 049 050001	KESMESİZ MODÜL	10 ad.	250	5,75 \$
888 049 050002	KESMELİ MODÜL	10 ad.	250	6,90 \$
888 049 050003	İRTİBATLAMA ALETİ	1 ad.	50	17,25 \$



Kod	Ürün Adı	Kutu Mt./Ad.	Koli Adet	Fiyat (₺)
<b>İKAZ KORNASI</b>				
026 112 010001	İKAZ KORNASI 220 V	1 ad.	45	703,70
028 120 000001	İKAZ BUTONU (KARE)	2 ad.	90	222,22
<b>ALARM KORNA ve YANGIN İHBAR BUTONU</b>				
010 090 050050	RESELENEBİLİR BUTON	2 ad.	90	1.037,04
010 090 050051	RESELENEBİLİR BUTON ( KAPAKLI)	1 ad.	90	1.111,11
028 120 010006	ALARM KORNA PLASTİK	1 ad.	30	981,48
028 120 010005	ALARM KORNA DÖKÜM	1 ad.	30	1.129,63
<b>SİRENLER</b>				
102 111 000012	LEDLİ FLAŞÖRLÜ ELEKTRONİK SİREN 12V	1 ad.	25	518,52
102 111 000024	LEDLİ FLAŞÖRLÜ ELEKTRONİK SİREN 24V	1 ad.	25	518,52
102 111 000220	LEDLİ FLAŞÖRLÜ ELEKTRONİK SİREN 220V	1 ad.	25	555,56
102 111 000221	LEDLİ FLAŞÖRLÜ ELEKTRONİK SİREN 220V. (YENİ MODEL)	1 ad.	30	740,74
888 111 050004	MS190 MINI SİREN (105 db)	1 ad.	40	15,30 \$
026 111 010001	AS. 1 MOTORLU SİREN (PLS. GÖV.)220V,100W (110 db.)	1 ad.	20	2.111,11
026 111 010002	AS. 2 MOTORLU SİREN (PLS.GÖV.)220V,100W (117 db.)	1 ad.	12	2.296,30
026 111 010003	AS. 1 MOTORLU SİREN (METAL.GÖV.)220V,100W (115 db.)	1 ad.	20	2.592,59
026 111 010004	AS. 2 MOTORLU SİREN (METAL.GÖV.)220V,100W (120 db.)	1 ad.	12	3.148,15
026 111 010005	AS.3 MOTORLU SİREN 220V-280W (130 db.)	1 ad.	-	20.370,37

## ME-FAN ASPIRATÖR ÇEŞİTLERİ

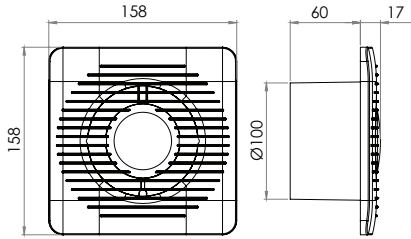

### 100 mm



Çalışma Akımı	220-240V / 50-60Hz
Emiş Hacmi	100m³/h
Devir Hızı	2450 rpm
Ses	43 dB
Güç	12W

ÜRÜN KODU	: 001 211 000100 00 00
ÜRÜN ADI	: MUTLUSAN ME-FAN 100 ASPIRATÖR
AMBALAJ ADET / KOLİ	: 1 / 20
FİYAT (₺)	: 500,00 ₺

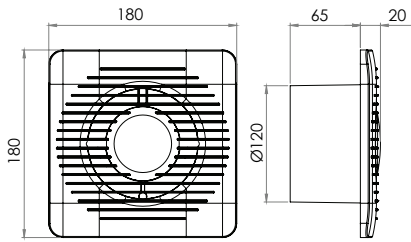

### 120 mm



Çalışma Akımı	220-240V / 50-60Hz
Emiş Hacmi	120m³/h
Devir Hızı	1900 rpm
Ses	47 dB
Güç	15W

ÜRÜN KODU	: 001 211 000120 00 00
ÜRÜN ADI	: MUTLUSAN ME-FAN 120 ASPIRATÖR
AMBALAJ ADET / KOLİ	: 1 / 20
FİYAT (₺)	: 518,52 ₺

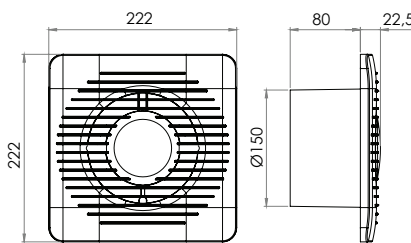

### 150 mm



Çalışma Akımı	220-240V / 50-60Hz
Emiş Hacmi	150m³/h
Devir Hızı	1350 rpm
Ses	47 dB
Güç	20W

ÜRÜN KODU	: 001 211 000150 00 00
ÜRÜN ADI	: MUTLUSAN ME-FAN 150 ASPIRATÖR
AMBALAJ ADET / KOLİ	: 1 / 12
FİYAT (₺)	: 777,78 ₺

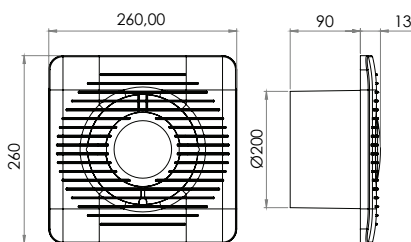

### 200 mm

Çalışma Akımı	220-240V / 50-60Hz
Emiş Hacmi	200m³/h
Devir Hızı	1200 rpm
Ses	55 dB
Güç	40W

ÜRÜN KODU	: 001 211 000200 00 00
ÜRÜN ADI	: MUTLUSAN ME-FAN 200 ASPIRATÖR
AMBALAJ ADET / KOLİ	: 1 / 6
FİYAT (₺)	: 1.370,37 ₺



## MUTLUSAN ASPIRATÖR ÇEŞİTLERİ

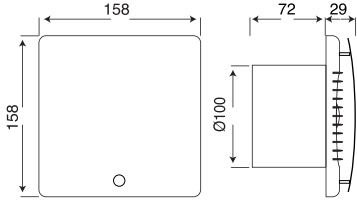

### 100 mm

Çalışma Akımı	220-240V / 50-60Hz
Emiş Hacmi	100m <sup>3</sup> /h
Devir Hızı	2450 rpm
Ses	43 dB
Güç	12W

<b>ÜRÜN KODU</b>	: 001 111 100100 00 00
<b>ÜRÜN ADI</b>	: MUTLUSAN DEKORA 100 KAPALI TIP ASPIRATÖR
<b>AMBALAJ ADET / KOLİ</b>	: 1 / 20
<b>FİYAT (₺)</b>	: 618,45 ₺

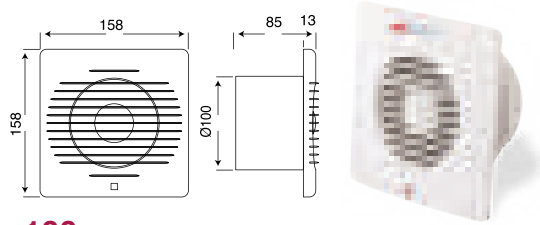

### 100 mm

Çalışma Akımı	220-240V / 50-60Hz
Emiş Hacmi	100m <sup>3</sup> /h
Devir Hızı	2450 rpm
Ses	43 dB
Güç	12W

<b>ÜRÜN KODU</b>	: 001 111 000100 00 00
<b>ÜRÜN ADI</b>	: MUTLUSAN AIR 100 ASPIRATÖR
<b>AMBALAJ ADET / KOLİ</b>	: 1 / 20
<b>FİYAT (₺)</b>	: 574,07 ₺

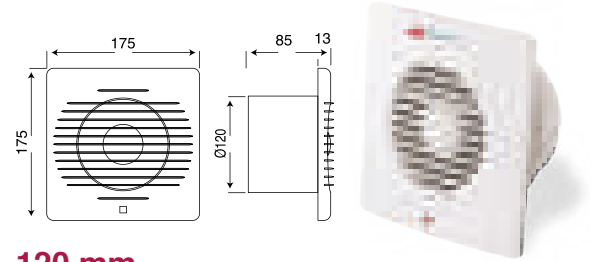

### 120 mm

Çalışma Akımı	220-240V / 50-60Hz
Emiş Hacmi	120m <sup>3</sup> /h
Devir Hızı	1900 rpm
Ses	47 dB
Güç	15W

<b>ÜRÜN KODU</b>	: 001 111 000120 00 00
<b>ÜRÜN ADI</b>	: MUTLUSAN AIR 120 ASPIRATÖR
<b>AMBALAJ ADET / KOLİ</b>	: 1 / 20
<b>FİYAT (₺)</b>	: 592,59 ₺

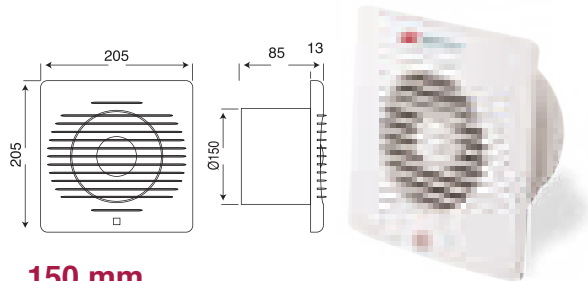

### 150 mm

Çalışma Akımı	220-240V / 50-60Hz
Emiş Hacmi	150m <sup>3</sup> /h
Devir Hızı	1350 rpm
Ses	47 dB
Güç	20W

<b>ÜRÜN KODU</b>	: 001 111 000150 00 00
<b>ÜRÜN ADI</b>	: MUTLUSAN AIR 150 ASPIRATÖR
<b>AMBALAJ ADET / KOLİ</b>	: 1 / 16
<b>FİYAT (₺)</b>	: 851,85 ₺

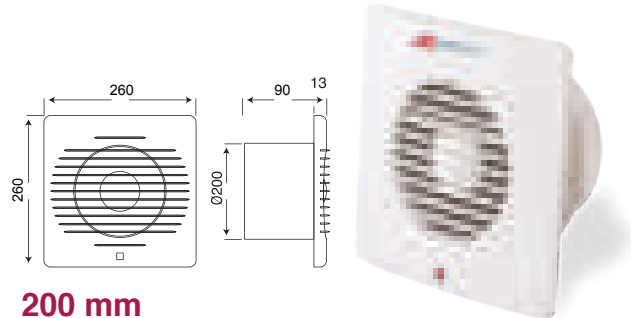

### 200 mm

Çalışma Akımı	220-240V / 50-60Hz
Emiş Hacmi	200m <sup>3</sup> /h
Devir Hızı	1000 rpm
Ses	55 dB
Güç	40W

<b>ÜRÜN KODU</b>	: 001 111 000200 00 00
<b>ÜRÜN ADI</b>	: MUTLUSAN AIR 200 ASPIRATÖR
<b>AMBALAJ ADET / KOLİ</b>	: 1 / 6
<b>FİYAT (₺)</b>	: 1.481,48 ₺

Bluetooth™

Uzaktan Kumandalı



- 52cm - 40 cm pervane
- Düşük enerjili yüksek verimli motor
- İki yönlü fan çalışma özelliği
- Uzaktan kumanda
- 6 ayarlanabilir hız seçeneği
- Zaman ayarı
- Işık parlaklığı ve 3 renk ayarı (beyaz - gün ışığı - soğuk beyaz)
- Bluetooth - müzik fonksiyonu
- Hoparlör
- LED aydınlatma

YENİ

## AYDINLATMALI TAVAN VANTİLATÖRÜ (BLUETOOTHLU)

Ürün Kodu	Ürün Adı	Kutu Adedi	Fiyat (₺)
001 038 300100 00 00	AYDINLATMALI TAVAN ARMATÜRÜ (BLUETOOTHLU) - BÜYÜK BOY - 52CM	1	13.750,00
001 038 300102 00 00	AYDINLATMALI TAVAN ARMATÜRÜ (BLUETOOTHLU) - KÜÇÜK BOY - 40 CM	1	11.250,00

E

## EXIT - ACİL AYDINLATMA ARMATÜRLERİ (LEDLİ) - IP20 CE



102 038 0008XX - CEXA

FİYAT : 814,81 ₺

- \*GÖVDE : ABS
- \*CAM : Polistren (PS) isteğe bağlı Akrilik(PMMA) veya Policarbon(PC)
- \*BASKI : Akrilik ışık geçirgen Translucent Folyo
- \*ÇALIŞMA : Acil de ve Şebeke de sürekli çalışma
- \*PIL : 3.6V 80mAH NİMH (NikelMethalhürid)
- \*ŞARJ SÜRESİ : 14-20 Saat
- \*DEŞARJ SÜRESİ : 180 Dk
- \*KORUMA SINIFI : IP20
- \*LED : 4.8mm 6000K Beyaz Mantar Led  
veya 2835 6400K EDISON OPTO SMD Led
- TÜKETİM : 2 Watt

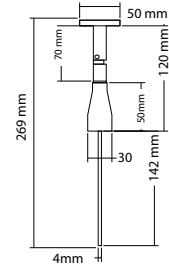
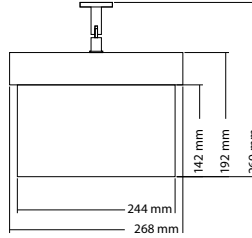













01	02	03	04	05	06	07	08
09	10	11	12	13	14		
15	16	17	18	19	20		
21	22	23	24	25	26		
27	28	29	30	31	32		
33	34	35	36				
37	38	39	40	41	42	43	
44	45	46	47	48	49	50	51
52	53	54	55	56	57	58	59
60	61	62	63	64	65		

\*Sipariş Verdiğiniz Ürünün Sembol Kodunu Yazmayı Unutmayınız.

\*Ürün Kodunun Son 2 hanesi olan XX Rakamları Ürünün Sembol Kodunu belirtmektedir.

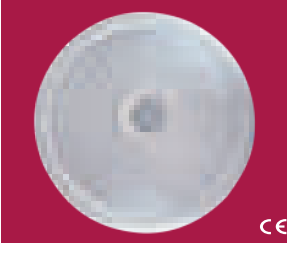
## LED ARMATÜR ÇEŞİTLERİ

	RENK	BEYAZ	SİYAH		ÜRÜN KODU	016 038 701522	
	ÜRÜN KODU	016 038 701500	016 038 701511		ÜRÜN ADI	LED GLOP ARMATÜR KROM - IP20	
	ÜRÜN ADI	LED GLOP ARMATÜR IP20			LÜMEN/WATT	2000Lm/20W	
	LÜMEN/WATT	2000Lm/20W			KELVIN	6400K	
	KELVIN	6400K			AMB. AD./KOLİ	24	
	AMB. AD./KOLİ	24			FİYAT (₺)	555,56	
	FİYAT (₺)	462,96					
	ÜRÜN KODU	016 038 701700			ÜRÜN KODU	016 038 701600	
	ÜRÜN ADI	18W NEMLİYER LED OVAL ARM. - BEYAZ			ÜRÜN ADI	22W NEMLİYER LED GLOP ARM. - BEYAZ	
	LÜMEN/WATT	1900Lm/18W			LÜMEN/WATT	2340Lm/22W	
	KELVIN	6400K			KELVIN	6400K	
	AMB. AD./KOLİ	1/40			AMB. AD./KOLİ	1/40	
	FİYAT (₺)	500,00			FİYAT (₺)	500,00	
	RENK	BEYAZ	SİYAH		RENK	BEYAZ	SİYAH
	ÜRÜN KODU	016 038 701100	016 038 701111		ÜRÜN KODU	016 038 701200	016 038 701211
	ÜRÜN ADI	LEDLIGHT-1 LEDLİ ARM.			ÜRÜN ADI	LEDLIGHT-2 LEDLİ ARM.	
	LÜMEN/WATT	1500Lm/15W			LÜMEN/WATT	2000Lm/20W	
	KELVIN	6400K			KELVIN	6400K	
	KUTU ADEDİ	30			KUTU ADEDİ	20	
	FİYAT (₺)	259,26			FİYAT (₺)	333,33	
	RENK	BEYAZ	SİYAH		RENK	BEYAZ	SİYAH
	ÜRÜN KODU	016 038 701300	016 038 701311		ÜRÜN KODU	016 038 701400	016 038 701411
	ÜRÜN ADI	LEDLIGHT-3 LEDLİ ARM.			ÜRÜN ADI	LEDLIGHT-4 LEDLİ ARM.	
	LÜMEN/WATT	1500Lm/15W			LÜMEN/WATT	2000Lm/20W	
	KELVIN	6400K			KELVIN	6400K	
	KUTU ADEDİ	30			KUTU ADEDİ	20	
	FİYAT (₺)	259,26			FİYAT (₺)	333,33	
	ÜRÜN KODU	001 038 250021 00 00			ÜRÜN KODU	001 038 250022 00 00	
	ÜRÜN ADI	360° SENSÖRLÜ TAVAN ARM. ACİL KİTLİ (2x25W) (PİL DAHİL)			ÜRÜN ADI	360° SENSÖRLÜ TAVAN ARMATÜRÜ (2x25W)	
	AMB. AD./KOLİ	1/12			AMB. AD./KOLİ	1/12	
	FİYAT (₺)	1.407,41			FİYAT (₺)	685,19	
	ÜRÜN KODU	001 038 250026 00 00			ÜRÜN KODU	001 038 250027 00 00	
	ÜRÜN ADI	SENSÖRLÜ GLOP ARMATÜRÜ 2XE27 PLS.			ÜRÜN ADI	SENSÖRLÜ GLOP ARMATÜRÜ LEDLİ PLS.	
	AMB. AD./KOLİ	1/12			AMB. AD./KOLİ	1/12	
	FİYAT (₺)	555,56			FİYAT (₺)	814,81	
	ÜRÜN KODU	016 038 250085			ÜRÜN KODU	078 039 500100	
	ÜRÜN ADI	ÇINAR DUVAR APLİK PLS, SOFT			ÜRÜN ADI	SENSÖRLÜ DUVAR APLİK E-27 DUYLU	
	AMB. AD./KOLİ	1/24			AMB. AD./KOLİ	1/20	
	FİYAT (₺)	703,70			FİYAT (₺)	703,70	

## ARMATÜR ÇEŞİTLERİ

	RENK	BEYAZ	CEVİZ
	ÜRÜN KODU	016 038 250086	016 038 250087
	ÜRÜN ADI	İNCİ TAVAN ARMATÜR	
	KUTU ADEDİ	4/32	
	FİYAT (₺)	233,33	285,19

	RENK	BEYAZ	CEVİZ
	ÜRÜN KODU	016 038 250088	016 038 250089
	ÜRÜN ADI	İNCİ APLİK - DUVAR ARMATÜR	
	KUTU ADEDİ	4/64	
	FİYAT (₺)	159,26	222,22

	ÜRÜN KODU	016 038 250090
	ÜRÜN ADI	YILDIZ TAVAN ARMATÜRÜ
	AMB. AD./KOLİ	8/64
	FİYAT (₺)	129,63

	YENİ	ÜRÜN KODU	016 038 710017
		ÜRÜN ADI	MINİ LÜX GLOB ARMATÜR - BEYAZ
		AMB. AD./KOLİ	8/48
		FİYAT (₺)	203,70

	ÜRÜN KODU	078 039 100005
	ÜRÜN ADI	NERGİS APLİK
	AMB. AD./KOLİ	8/64
	FİYAT (₺)	151,85

	YENİ	ÜRÜN KODU	016 038 710018
		ÜRÜN ADI	MINİ LÜX GLOB ARMATÜR - SİYAH
		AMB. AD./KOLİ	8/48
		FİYAT (₺)	203,70

	ÜRÜN KODU	001 038 250016 00 00
	ÜRÜN ADI	PAPATYA HAZIR ASKI TİJ TAKIMI
	AMB. AD./KOLİ	25/275
	FİYAT (₺)	59,26

	YENİ	ÜRÜN KODU	016 038 710019
		ÜRÜN ADI	MINİ LÜX GLOB ARMATÜR - GRİ
		AMB. AD./KOLİ	8/48
		FİYAT (₺)	203,70

	ÜRÜN KODU	001 038 250017 00 00
	ÜRÜN ADI	BÜYÜK PAPATYA HAZIR ASKI TİJ TAKIMI
	AMB. AD./KOLİ	10/80
	FİYAT (₺)	96,30

	ÜRÜN KODU	016 038 250020
	ÜRÜN ADI	HAZIR ASKI TİJ TAKIMI (PLASTİK DUYLU)
	AMB. AD./KOLİ	60 / -
	FİYAT (₺)	48,15

	ÜRÜN KODU	001 038 250018 00 00
	ÜRÜN ADI	HAZIR ASKI TİJ TAKIMI
	AMB. AD./KOLİ	25/300
	FİYAT (₺)	55,56

	ÜRÜN KODU	024 109 010005
	ÜRÜN ADI	YAĞMUR DUY (PLASTİK YANMAZ) E27
	AMB. AD./KOLİ	50
	FİYAT (₺)	43,57

## ARMATÜR ÇEŞİTLERİ



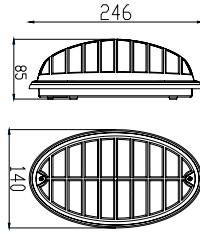

ÜRÜN KODU	016 038 411110
ÜRÜN ADI	AQUA KAFESLİ APLİK BEYAZ - IP65
AMB. AD./KOLİ	1/20
FİYAT (₺)	326,18



ÜRÜN KODU	016 038 411120
ÜRÜN ADI	AQUA KAFESLİ APLİK SİYAH - IP65
AMB. AD./KOLİ	1/20
FİYAT (₺)	326,18

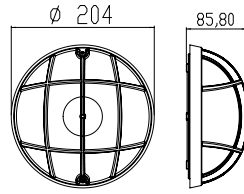

ÜRÜN KODU	016 038 411300
ÜRÜN ADI	OPAK KAFESLİ ARM. BEYAZ - IP54
AMB. AD./KOLİ	1/24
FİYAT (₺)	361,60

ÜRÜN KODU	016 038 411311
ÜRÜN ADI	OPAK KAFESLİ ARM. SİYAH - IP54
AMB. AD./KOLİ	1/24
FİYAT (₺)	361,60



ÜRÜN KODU	016 038 410600
ÜRÜN ADI	ELİPS OPAL ARM. BEYAZ - IP65
AMB. AD./KOLİ	1/10
FİYAT (₺)	580,03

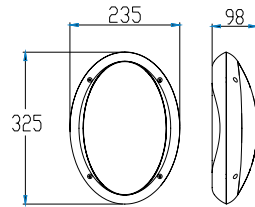

ÜRÜN KODU	016 038 410611
ÜRÜN ADI	ELİPS OPAL ARM. SİYAH - IP65
AMB. AD./KOLİ	1/10
FİYAT (₺)	580,03



ÜRÜN KODU	016 038 410500
ÜRÜN ADI	OPAL ARMATÜR BEYAZ - IP65
AMB. AD./KOLİ	1/10
FİYAT (₺)	565,27

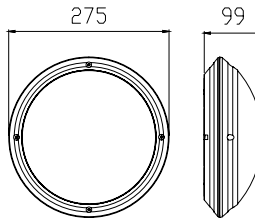



ÜRÜN KODU	016 038 410511
ÜRÜN ADI	OPAL ARMATÜR SİYAH - IP65
AMB. AD./KOLİ	1/10
FİYAT (₺)	565,27



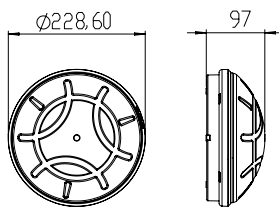

ÜRÜN KODU	016 038 410800
ÜRÜN ADI	OPAK ARMATÜR BEYAZ - IP65
AMB. AD./KOLİ	1/16
FİYAT (₺)	407,33



ÜRÜN KODU	016 038 410811
ÜRÜN ADI	OPAK ARMATÜR SİYAH - IP65
AMB. AD./KOLİ	1/16
FİYAT (₺)	407,33

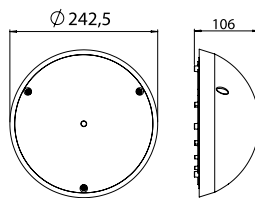

ÜRÜN KODU	016 038 700100
ÜRÜN ADI	DOLUNAY OPAK ARM. BEYAZ - IP54
AMB. AD./KOLİ	1/16
FİYAT (₺)	414,73





ÜRÜN KODU	016 038 700111
ÜRÜN ADI	DOLUNAY OPAK ARM. SİYAH - IP54
AMB. AD./KOLİ	1/16
FİYAT (₺)	414,73

## ARMATÜR ÇEŞİTLERİ

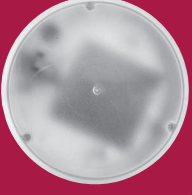

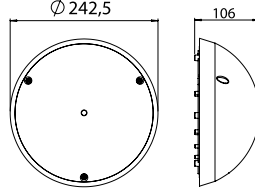

	ÜRÜN KODU	016 038 700200
	ÜRÜN ADI	DOLUNAY ŞEFFAF ARM. BEYAZ - IP54
	AMB. AD./KOLİ	1/16
	FİYAT (₺)	414,73

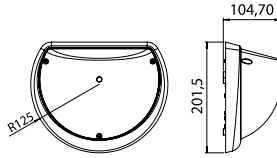

	ÜRÜN KODU	016 038 700211
	ÜRÜN ADI	DOLUNAY ŞEFFAF ARM. SİYAH - IP54
	AMB. AD./KOLİ	1/16
	FİYAT (₺)	414,73

	ÜRÜN KODU	016 038 700300
	ÜRÜN ADI	DOLUNAY OPAK APLİK BEYAZ - IP54
	AMB. AD./KOLİ	1/20
	FİYAT (₺)	389,62



	ÜRÜN KODU	016 038 700311
	ÜRÜN ADI	DOLUNAY OPAK APLİK SİYAH - IP54
	AMB. AD./KOLİ	1/20
	FİYAT (₺)	389,62

	ÜRÜN KODU	016 038 700400
	ÜRÜN ADI	DOLUNAY ŞEFFAF APLİK BEYAZ - IP54
	AMB. AD./KOLİ	1/20
	FİYAT (₺)	389,62

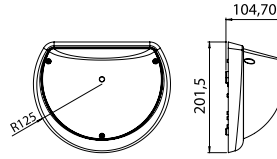

	ÜRÜN KODU	016 038 700411
	ÜRÜN ADI	DOLUNAY ŞEFFAF APLİK SİYAH - IP54
	AMB. AD./KOLİ	1/20
	FİYAT (₺)	389,62

	ÜRÜN KODU	001 038 150101 00 00
	ÜRÜN ADI	BEGONYA NEMLİYER TAVAN ARMATÜRÜ KLASİK - IP54
	AMB. AD./KOLİ	12
	FİYAT (₺)	500,00

	ÜRÜN KODU	078 039 100006
	ÜRÜN ADI	ÇİFT DUYLU TAVAN ARMATÜR - IP20
	AMB. AD./KOLİ	2/32
	FİYAT (₺)	290,48

	ÜRÜN KODU	001 038 140101 00 00
	ÜRÜN ADI	BEGONYA NEMLİYER TAVAN ARMATÜRÜ YATAY - IP54
	AMB. AD./KOLİ	12
	FİYAT (₺)	500,00

	ÜRÜN KODU	001 038 130101 00 00
	ÜRÜN ADI	BEGONYA NEMLİYER TAVAN ARMATÜRÜ DİKEY - IP54
	AMB. AD./KOLİ	12
	FİYAT (₺)	500,00



## APLIK ÇEŞİTLERİ



CE

ÜRÜN ADI	ZETA 4'LÜ APLİK - IP64
ÜRÜN KODU	001 038 200102 00 11
RENK	3000K
LÜMEN/WATT	480Lm/4W
KUTU ADEDİ	1
FİYAT (\$)	10,00 \$



CE

ÜRÜN ADI	ZETA 4'LÜ APLİK - IP64
ÜRÜN KODU	001 038 201102 00 11
RENK	2R+2B
LÜMEN/WATT	480Lm/4W
KUTU ADEDİ	1
FİYAT (\$)	10,00 \$



CE

ÜRÜN ADI	ZETA 6'LI APLİK - IP64
ÜRÜN KODU	001 038 200103 00 11
RENK	3000K
LÜMEN/WATT	720Lm/6W
KUTU ADEDİ	1
FİYAT (\$)	10,67 \$



CE

ÜRÜN ADI	ZETA 6'LI APLİK - IP64
ÜRÜN KODU	001 038 201103 00 11
RENK	2R+2G+2B
LÜMEN/WATT	720Lm/6W
KUTU ADEDİ	1
FİYAT (\$)	10,67 \$



CE

ÜRÜN ADI	ZETA 8'Lİ APLİK - IP64
ÜRÜN KODU	001 038 200104 00 11
RENK	3000K
LÜMEN/WATT	960Lm/8W
KUTU ADEDİ	1
FİYAT (\$)	11,33 \$



CE

ÜRÜN ADI	ZETA 8'Lİ APLİK - IP64
ÜRÜN KODU	001 038 201104 00 11
RENK	2R+2G+2B+2Y
LÜMEN/WATT	960Lm/8W
KUTU ADEDİ	1
FİYAT (\$)	11,33 \$



CE

ÜRÜN ADI	ZETA 10'LU APLİK - IP64
ÜRÜN KODU	001 038 200105 00 11
RENK	3000K
LÜMEN/WATT	1200Lm/10W
KUTU ADEDİ	1
FİYAT (\$)	15,00 \$



CE

ÜRÜN ADI	ZETA 10'LU APLİK - IP64
ÜRÜN KODU	001 038 201105 00 11
RENK	2R+2G+2B+2G+2R
LÜMEN/WATT	1200Lm/10W
KUTU ADEDİ	1
FİYAT (\$)	15,00 \$

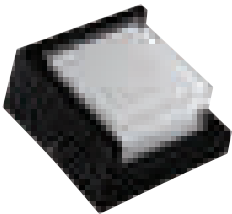

CE

ÜRÜN ADI	KARE KÜÇÜK APLİK - IP44
ÜRÜN KODU	001 038 200108 00 11
RENK	3000K
LÜMEN/WATT	500Lm/5W
KUTU ADEDİ	1
FİYAT (\$)	11,00 \$

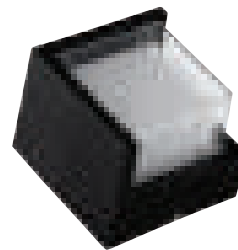

CE

ÜRÜN ADI	KARE BÜYÜK APLİK - IP44
ÜRÜN KODU	001 038 200112 00 11
RENK	3000K
LÜMEN/WATT	1200Lm/12W
KUTU ADEDİ	1
FİYAT (\$)	19,33 \$



CE

ÜRÜN ADI	MİNA APLİK - IP64
ÜRÜN KODU	001 038 200116 00 11
RENK	3000K
LÜMEN/WATT	1000Lm/10W
KUTU ADEDİ	1
FİYAT (\$)	11,00 \$



CE

ÜRÜN ADI	MİLA APLİK - IP64
ÜRÜN KODU	001 038 200118 00 11
RENK	3000K
LÜMEN/WATT	1000Lm/10W
KUTU ADEDİ	1
FİYAT (\$)	19,33 \$



## APLIK ÇEŞİTLERİ



ÜRÜN ADI	ALYA KÜÇÜK APLİK - IP44
ÜRÜN KODU	001 038 200110 00 11
RENK	3000K
LÜMEN/WATT	500Lm/5W
KUTU ADEDİ	1
FİYAT (\$)	11,00 \$



ÜRÜN ADI	ALYA BÜYÜK APLİK - IP44
ÜRÜN KODU	001 038 200114 00 11
RENK	3000K
LÜMEN/WATT	1200Lm/12W
KUTU ADEDİ	1
FİYAT (\$)	19,33 \$



ÜRÜN ADI	PERA APLİK - IP64
ÜRÜN KODU	001 038 200120 00 11
RENK	3000K
LÜMEN/WATT	660Lm/6W
KUTU ADEDİ	1
FİYAT (\$)	13,14 \$



ÜRÜN ADI	HERA APLİK - IP64
ÜRÜN KODU	001 038 200122 00 11
RENK	3000K
LÜMEN/WATT	660Lm/6W
KUTU ADEDİ	1
FİYAT (\$)	13,14 \$

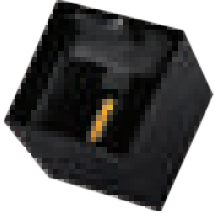

ÜRÜN ADI	HAPPY APLİK - IP64
ÜRÜN KODU	001 038 200124 00 11
RENK	3000K
LÜMEN/WATT	660Lm/6W
KUTU ADEDİ	1
FİYAT (\$)	12,77 \$



*Karanlığı Işıkla Buluşturur*  
**SUNBOX** Ledli Solar  
Projektör



## SOLAR BAHÇE APLİK ÇEŞİTLERİ

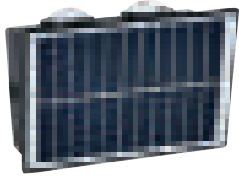

CE

ÜRÜN ADI	ZETA 4'LÜ LEDLİ SOLAR APLİK - IP65
ÜRÜN KODU	016 038 200102
RENK	3000K
LÜMEN/WATT	60Lm/10W
AMB. AD./KOLİ	1/50
FİYAT (\$)	20,00 \$

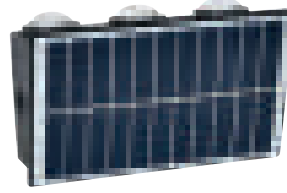

CE

ÜRÜN ADI	ZETA 6'Lİ LEDLİ SOLAR APLİK - IP65
ÜRÜN KODU	016 038 200104
RENK	3000K
LÜMEN/WATT	90Lm/15W
AMB. AD./KOLİ	1/50
FİYAT (\$)	28,33 \$



CE

ÜRÜN ADI	VENUS LEDLİ SENSÖRLÜ SOLAR APLİK - IP65
ÜRÜN KODU	016 038 200106
RENK	3000K
LÜMEN/WATT	60Lm/10W
AMB. AD./KOLİ	1/80
FİYAT (\$)	18,33 \$



CE

ÜRÜN ADI	MARS LEDLİ SOLAR BAHÇE ARMATÜRÜ - IP65
ÜRÜN KODU	016 038 200108
RENK	3000K
LÜMEN/WATT	40Lm/7W
AMB. AD./KOLİ	1/20
FİYAT (\$)	26,67 \$



CE

ÜRÜN ADI	JUPİTER LEDLİ SOLAR BAHÇE ARMATÜRÜ - IP65
ÜRÜN KODU	016 038 200110
RENK	3000-4500K KUMANDALI
LÜMEN/WATT	380Lm/20W
AMB. AD./KOLİ	1/20
FİYAT (\$)	63,33 \$



CE

ÜRÜN ADI	NEPTUNE LEDLİ SOLAR APLİK - IP65
ÜRÜN KODU	016 038 200112
RENK	3000-4500K KUMANDALI
LÜMEN/WATT	380Lm/20W
AMB. AD./KOLİ	1/20
FİYAT (\$)	38,11 \$



CE

ÜRÜN ADI	SATURN LEDLİ SOLAR BAHÇE ARMATÜRÜ - IP65
ÜRÜN KODU	016 038 200114
RENK	3000-4500K KUMANDALI
LÜMEN/WATT	960Lm/50W
AMB. AD./KOLİ	1/6
FİYAT (\$)	89,91 \$



CE

ÜRÜN ADI	SUNBOX LEDLİ SOLAR PROJEKTÖR - IP65
ÜRÜN KODU	016 038 200116
RENK	W+R+B
LÜMEN/WATT	1420Lm/200W
AMB. AD./KOLİ	1/20
FİYAT (\$)	40,00 \$

YENİ

# BAHÇE AYDINLATMA



ÜRÜN ADI	BURGAZ APLİK 28 CM - IP54
ÜRÜN KODU	016 038 710002
DUY	E27
AMB. AD./KOLİ	1/18
FİYAT (₺)	518,52



ÜRÜN ADI	SEDEF APLİK 28 CM - IP54
ÜRÜN KODU	016 038 710006
DUY	E27
AMB. AD./KOLİ	1/20
FİYAT (₺)	518,52



ÜRÜN ADI	ALİZE KÜP SET ÜSTÜ 27 CM - IP54
ÜRÜN KODU	016 038 710020
DUY	E27
AMB. AD./KOLİ	1/12
FİYAT (₺)	666,67



ÜRÜN ADI	ERDEK APLİK 25 CM - IP54
ÜRÜN KODU	016 038 710010
DUY	E27
AMB. AD./KOLİ	1/18
FİYAT (₺)	518,52



ÜRÜN ADI	MARMARA KÜP SET ÜSTÜ 27 CM - IP54
ÜRÜN KODU	016 038 710021
DUY	E27
AMB. AD./KOLİ	1/12
FİYAT (₺)	666,67

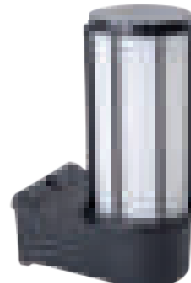

ÜRÜN ADI	MARMARA APLİK 25 CM - IP54
ÜRÜN KODU	016 038 710014
DUY	E27
AMB. AD./KOLİ	1/20
FİYAT (₺)	537,04

## BAHÇE ARMATÜRLERİ

Ürün Kodu	Ürün Adı	Ölçü	Ambalaj Adet/Koli	Fiyat (₺)
016 038 710005	SEDEF SET ÜSTÜ - IP54 - E27 DUY	42 CM	1/16	518,52
016 038 710007	SEDEF BOLLARD - IP54 - E27 DUY	60 CM	1/12	685,19
016 038 710008	SEDEF BOLLARD - IP54 - E27 DUY	80 CM	1/12	870,37



Ürün Kodu	Ürün Adı	Ölçü	Ambalaj Adet/Koli	Fiyat (₺)
016 038 710009	ERDEK SET ÜSTÜ- IP54 - E27 DUY	42 CM	1/18	518,52
016 038 710011	ERDEK BOLLARD - IP54 - E27 DUY	60 CM	1/12	685,19
016 038 710012	ERDEK BOLLARD - IP54 - E27 DUY	80 CM	1/12	870,37



Ürün Kodu	Ürün Adı	Ölçü	Ambalaj Adet/Koli	Fiyat (₺)
016 038 710001	BURGAZ SET ÜSTÜ - IP54 - E27 DUY	42 CM	1/18	518,52
016 038 710003	BURGAZ BOLLARD - IP54 - E27 DUY	60 CM	1/12	685,19
016 038 710004	BURGAZ BOLLARD - IP54 - E27 DUY	80 CM	1/12	870,37



Ürün Kodu	Ürün Adı	Ölçü	Ambalaj Adet/Koli	Fiyat (₺)
016 038 710013	MARMARA SET ÜSTÜ - IP54 - E27 DUY	42 CM	1/16	537,04
016 038 710015	MARMARA BOLLARD - IP54 - E27 DUY	60 CM	1/12	740,74
016 038 710016	MARMARA BOLLARD - IP54 - E27 DUY	80 CM	1/12	907,41



## BAHÇE ARMATÜRLERİ



CE IP43

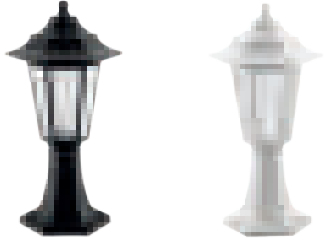

Ürün Kodu	Ürün Adı	Ambalaj Adet/Koli	Fiyat (₺)
016 038 010116	FLORA BAHÇE ARMATÜRÜ - SİYAH	1/12	462,96
016 038 020116	FLORA BAHÇE ARMATÜRÜ - BEYAZ	1/12	462,96

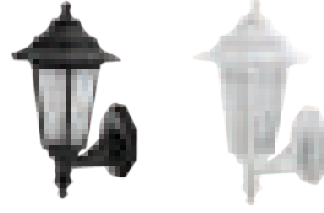

Ürün Kodu	Ürün Adı	Ambalaj Adet/Koli	Fiyat (₺)
016 038 010117	FLORA BAHÇE ARMATÜRÜ APLİK - SİYAH	1/12	462,96
016 038 020117	FLORA BAHÇE ARMATÜRÜ APLİK - BEYAZ	1/12	462,96



Ürün Kodu	Ürün Adı	Ambalaj Adet/Koli	Fiyat (₺)
016 038 412011	FLORA BAHÇE ARMATÜRÜ TAVAN TİPİ - SİYAH	1/12	500,00
016 038 412000	FLORA BAHÇE ARMATÜRÜ TAVAN TİPİ - BEYAZ	1/12	500,00

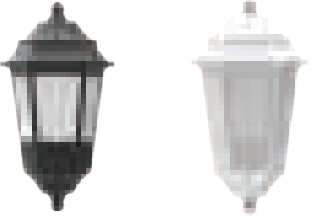

Ürün Kodu	Ürün Adı	Ambalaj Adet/Koli	Fiyat (₺)
016 038 412111	FLORA BAHÇE ARMATÜRÜ YARIM APLİK - SİYAH	1/20	407,41
016 038 412100	FLORA BAHÇE ARMATÜRÜ YARIM APLİK - SİYAH	1/20	407,41

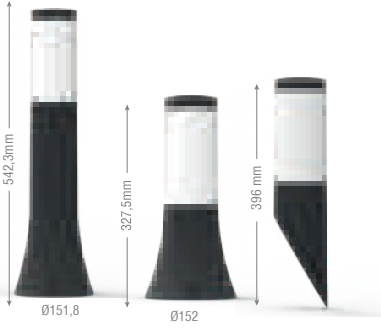

CE IP44

Ürün Kodu	Ürün Adı	Ölçü	Ambalaj Adet/Koli	Fiyat (₺)
016 038 010120	GARDEN UZUN YER AYDINLATMA - SİYAH	542,3mm x Ø151,8	1/8	518,52
016 038 010118	GARDEN YER AYDINLATMA - SİYAH	327,5mm x Ø152	1/12	425,93
016 038 010122	GARDEN DUVAR AYDINLATMA - SİYAH	396mm	1/20	407,41

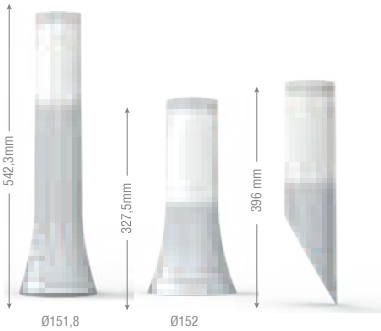

Ürün Kodu	Ürün Adı	Ölçü	Ambalaj Adet/Koli	Fiyat (₺)
016 038 010121	GARDEN UZUN YER AYDINLATMA - GRİ	542,3mm x Ø151,8	1/8	518,52
016 038 010119	GARDEN YER AYDINLATMA - GRİ	327,5mm x Ø152	1/12	425,93
016 038 010123	GARDEN DUVAR AYDINLATMA - GRİ	396mm	1/20	407,41

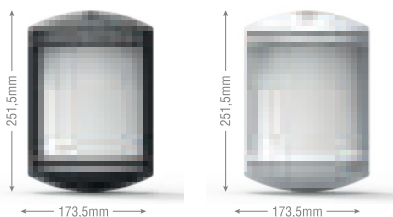

Ürün Kodu	Ürün Adı	Ambalaj Adet/Koli	Fiyat (₺)
016 038 010124	GARDEN APLİK - SİYAH	1/16	518,52
016 038 010125	GARDEN APLİK - GRİ	1/16	518,52

# PANO ve ENDÜSTRİYEL ÜRÜN GRUBU



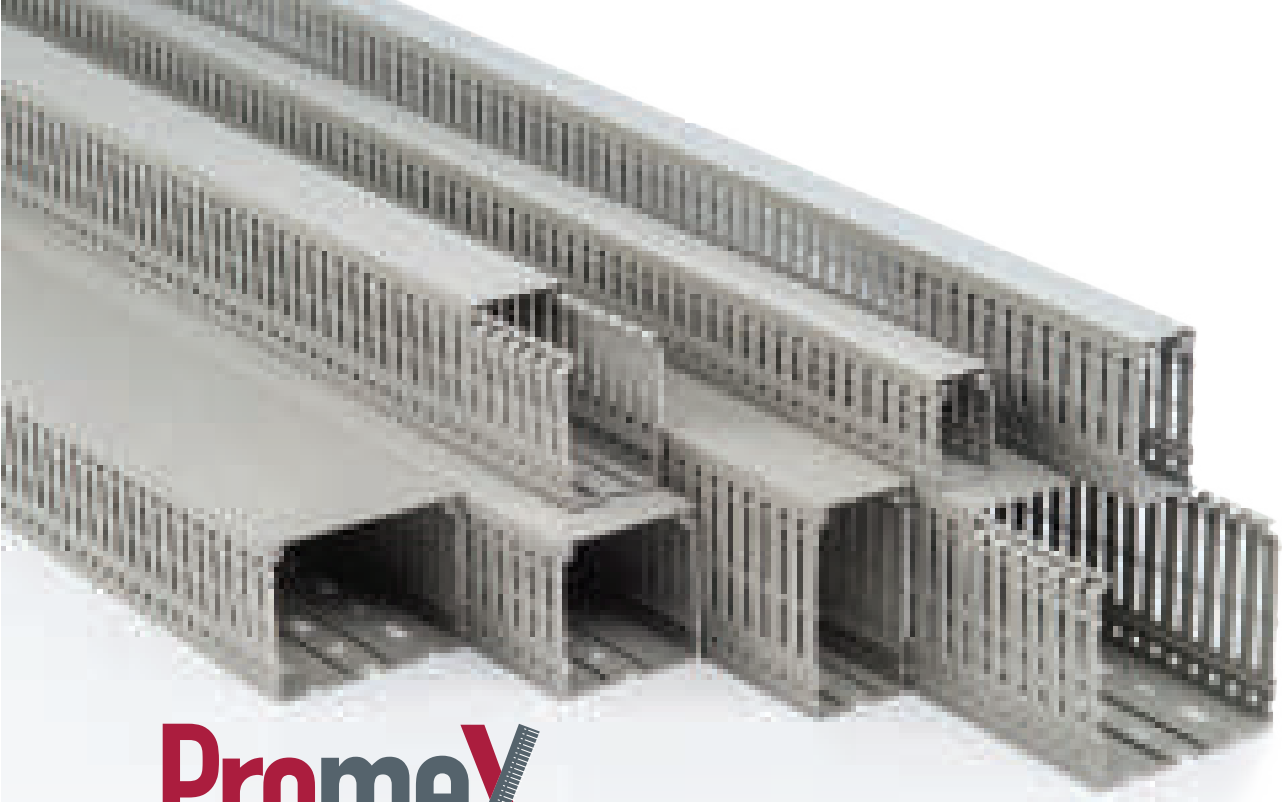

# Promex

## PANO TİPİ DELİKLİ KABLO KANALLARI



Kanal tırnakları tabanın üst noktasından, herhangi bir el aletine gereksinim duymadan 90 derecelik bükülme sonucu kolayca kırılabilir.

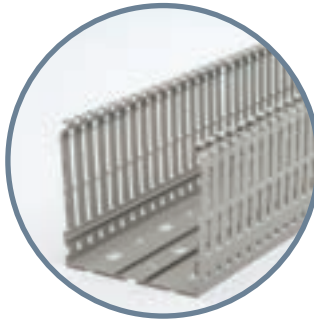

Özel tırnak tasarımı ile kablolarınızı sıkıştırabilirsiniz. Kanal içindeki kabloların, kablo bağı ile bağlanmasına imkan veren delikleri sayesinde daha düzenli ve hızlı kablolama imkanına sahip olursunuz.

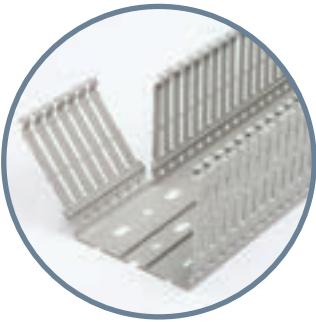

Kanal yan duvarı, kolay kırılma çizgileri sayesinde tabana sıfır olarak çıkarılabilir.



Özel kapak tasarımı, kanalın hangi konumda monte edildiğine bakılmaksızın kapağı kolayca monte etmemizi ve sökmemizi sağlar. Yoğun kablolamalarda bile kapağın kendinden çıkmasını engeller.

UL94-V0 alev iletmez özelliğe sahip PVC hammaddeden imal  
Slot aralığı 4/6/4 + 5/8/5 mm genişliğinde  
Taban montaj delikleri DIN 43659 standartına uygun  
Standart kanal boyları 2mt  
EN 50085-2-3 standartlarına uygun  
Her türlü sevkiyat ve depolama koşullarına dayanıklı özel karton ambalaj  
Standart renk RAL7030 Gri, istek üzerine diğer renkler üretilebilir  
CE, RoHS sertifikalı

Ürün Kodu	Ölçü (mm)	Ürün Adı	Slot Aralığı (mm)	Ambalaj/Mt.	Fiyat (₺)
<b>PROMEX DELİKLİ KABLO KANALI</b>					
001 105 025030 20 17	25x30	PROMEX DELİKLİ KABLO KANALI	4/6/4 mm	2m. 120	94,44
001 105 025040 20 17	25x40	PROMEX DELİKLİ KABLO KANALI	4/6/4 mm	2m. 128	96,30
001 105 025060 20 17	25x60	PROMEX DELİKLİ KABLO KANALI	4/6/4 mm	2m. 96	125,93
001 105 025080 20 17	25x80	PROMEX DELİKLİ KABLO KANALI	4/6/4 mm	2m. 64	157,41
001 105 040040 20 17	40x40	PROMEX DELİKLİ KABLO KANALI	4/6/4 mm	2m. 70	122,22
001 105 040060 20 17	40x60	PROMEX DELİKLİ KABLO KANALI	4/6/4 mm	2m. 60	144,44
001 105 040080 20 17	40x80	PROMEX DELİKLİ KABLO KANALI	4/6/4 mm	2m. 40	188,89
001 105 040100 20 17	40x100	PROMEX DELİKLİ KABLO KANALI	5/8/5 mm	2m. 40	228,81
001 105 060040 20 17	60x40	PROMEX DELİKLİ KABLO KANALI	4/6/4 mm	2m. 50	170,37
001 105 060060 20 17	60x60	PROMEX DELİKLİ KABLO KANALI	4/6/4 mm	2m. 48	203,70
001 105 060080 20 17	60x80	PROMEX DELİKLİ KABLO KANALI	4/6/4 mm	2m. 32	248,15
001 105 060100 20 17	60x100	PROMEX DELİKLİ KABLO KANALI	5/8/5 mm	2m. 32	266,67
001 105 080060 20 17	80x60	PROMEX DELİKLİ KABLO KANALI	4/6/4 mm	2m. 25	240,74
001 105 080080 20 17	80x80	PROMEX DELİKLİ KABLO KANALI	4/6/4 mm	2m. 24	296,30
001 105 080100 20 17	80x100	PROMEX DELİKLİ KABLO KANALI	5/8/5 mm	2m. 24	440,74
001 105 100060 20 17	100x60	PROMEX DELİKLİ KABLO KANALI	4/6/4 mm	2m. 20	329,63
001 105 100080 20 17	100x80	PROMEX DELİKLİ KABLO KANALI	4/6/4 mm	2m. 20	333,33
001 105 100100 20 17	100x100	PROMEX DELİKLİ KABLO KANALI	5/8/5 mm	2m. 16	518,52
001 105 120060 20 17	120x60	PROMEX DELİKLİ KABLO KANALI	4/6/4 mm	2m. 20	344,44
001 105 120080 20 17	120x80	PROMEX DELİKLİ KABLO KANALI	4/6/4 mm	2m. 16	451,85

#### PROMEX KABLO KANALI KAPAKLARI

001 016 100025 20 17	25'LİK	PROMEX KAPAK		50	27,78
001 016 100040 20 17	40'LİK	PROMEX KAPAK		50	35,19
001 016 100060 20 17	60'LİK	PROMEX KAPAK		50	53,70
001 016 100080 20 17	80'LİK	PROMEX KAPAK		50	66,67
001 016 100100 20 17	100'LÜK	PROMEX KAPAK		50	77,78
001 016 100120 20 17	120'LİK	PROMEX KAPAK		50	96,30

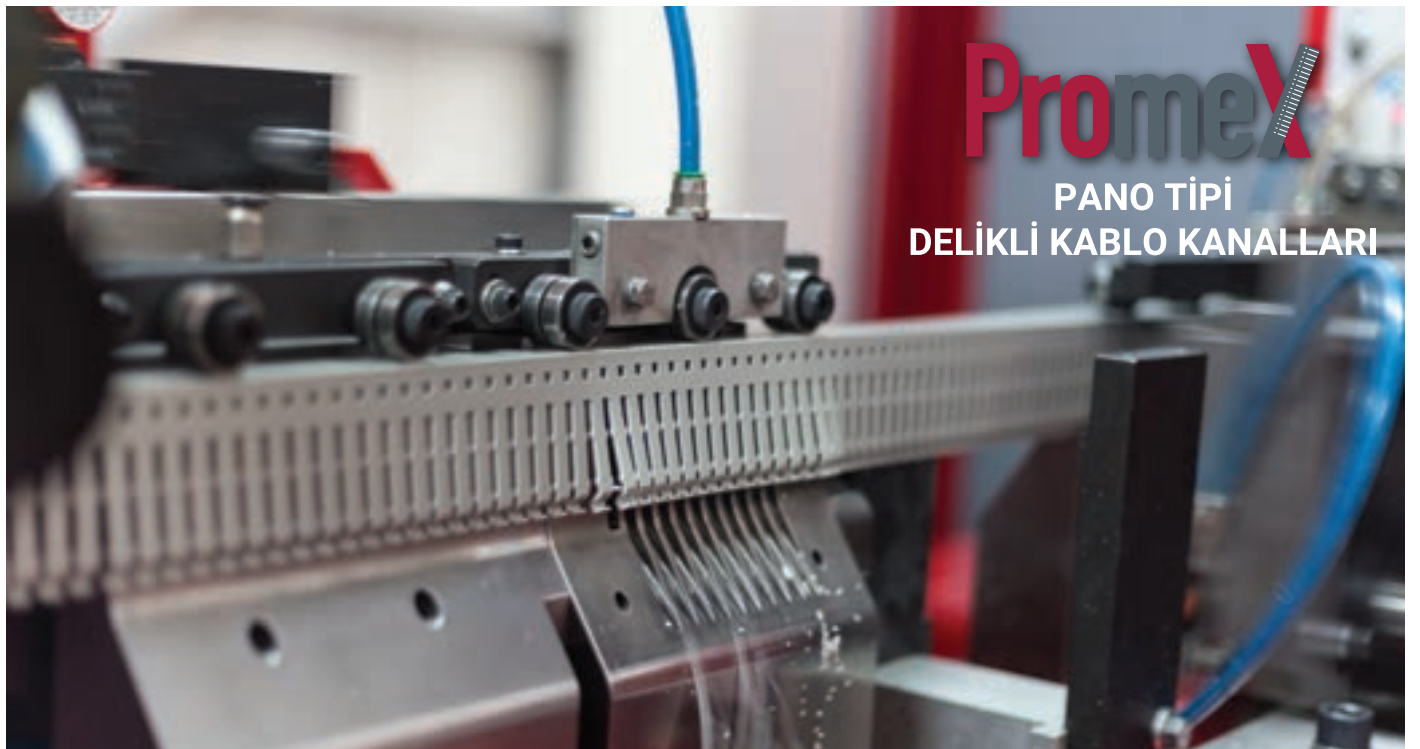

**Promex**  
PANO TİPİ  
DELİKLİ KABLO KANALLARI

XX : 10 1mt. delikli kablo kanalı için.  
XX : 20 2mt. delikli kablo kanalı için.

Ürün Kodu	Ölçü (mm)	Ürün Adı	Ambalaj Koli -1 mt	Ambalaj Koli - 2 mt	Fiyat (₺)
-----------	-----------	----------	--------------------	---------------------	-----------

### PANO İÇİN MEKS DELİKLİ KABLO KANALLAR (GRİ)

001 005 025025 XX 17	25x25	MEKS DELİKLİ KABLO KANALI(GRİ)	1mt. 64	2mt. 120	71,10
001 005 025040 XX 17	25x40	MEKS DELİKLİ KABLO KANALI(GRİ)	1mt. 40	2mt. 80	88,89
001 005 025060 XX 17	25x60	MEKS DELİKLİ KABLO KANALI(GRİ)	1mt. 36	2mt. 80	118,52
001 005 040040 XX 17	40x40	MEKS DELİKLİ KABLO KANALI(GRİ)	1mt. 25	2mt. 50	116,67
001 005 040060 XX 17	40x60	MEKS DELİKLİ KABLO KANALI(GRİ)	1mt. 24	2mt. 48	137,04
001 005 060040 XX 17	60x40	MEKS DELİKLİ KABLO KANALI(GRİ)	1mt. 24	2mt. 48	159,26
001 005 060060 XX 17	60x60	MEKS DELİKLİ KABLO KANALI(GRİ)	1mt. 16	2mt. 32	188,89
001 005 060080 XX 17	60x80	MEKS DELİKLİ KABLO KANALI(GRİ)	1mt. 12	2mt. 24	229,63
001 005 060100 XX 17	60x100	MEKS DELİKLİ KABLO KANALI(GRİ)	1mt. 8	2mt. 16	251,85
001 005 040080 XX 17	40x80	MEKS DELİKLİ KABLO KANALI(GRİ)	1mt. 18	2mt. 36	185,19
001 005 080060 XX 17	80x60	MEKS DELİKLİ KABLO KANALI(GRİ)	1mt. 12	2mt. 24	222,22
001 005 100060 XX 17	100x60	MEKS DELİKLİ KABLO KANALI(GRİ)	1mt. 8	2mt. 16	307,41
001 005 100100 XX 17	100x100	MEKS DELİKLİ KABLO KANALI(GRİ)	1mt. 4	2mt. 8	481,48

### PANO İÇİN MEKS DELİKLİ KABLO KANALLAR (MAVİ)

001 005 025025 XX 13	25x25	MEKS DELİKLİ KABLO KANALI(MAVİ)	1mt. 64	2mt. 120	74,20
001 005 025040 XX 13	25x40	MEKS DELİKLİ KABLO KANALI(MAVİ)	1mt. 40	2mt. 80	96,30
001 005 025060 XX 13	25x60	MEKS DELİKLİ KABLO KANALI(MAVİ)	1mt. 36	2mt. 80	129,63
001 005 040040 XX 13	40x40	MEKS DELİKLİ KABLO KANALI(MAVİ)	1mt. 25	2mt. 50	122,22
001 005 040060 XX 13	40x60	MEKS DELİKLİ KABLO KANALI(MAVİ)	1mt. 24	2mt. 48	148,15
001 005 060040 XX 13	60x40	MEKS DELİKLİ KABLO KANALI(MAVİ)	1mt. 24	2mt. 48	166,67
001 005 060060 XX 13	60x60	MEKS DELİKLİ KABLO KANALI(MAVİ)	1mt. 16	2mt. 32	204,71
001 005 060080 XX 13	60x80	MEKS DELİKLİ KABLO KANALI (MAVİ)	1mt. 12	2mt. 24	251,85
001 005 060100 XX 13	60x100	MEKS DELİKLİ KABLO KANALI (MAVİ)	1mt. 8	2mt. 16	277,78
001 005 040080 XX 13	40x80	MEKS DELİKLİ KABLO KANALI(MAVİ)	1mt. 18	2mt. 36	214,81
001 005 080060 XX 13	80x60	MEKS DELİKLİ KABLO KANALI(MAVİ)	1mt. 12	2mt. 24	259,26
001 005 100060 XX 13	100x60	MEKS DELİKLİ KABLO KANALI(MAVİ)	1mt. 8	2mt. 16	344,44
001 005 100100 XX 13	100x100	MEKS DELİKLİ KABLO KANALI(MAVİ)	1mt. 4	2mt. 8	518,52

### YAPIŞKAN BANTLI MEKS DELİKLİ KABLO KANALLAR (GRİ)

001 008 025025 XX 17	25x25	MEKS DELİKLİ KABLO KANALI(YPŞK. BANTLI)(GRİ)	1mt. 64	2mt. 120	77,90
001 008 025040 XX 17	25x40	MEKS DELİKLİ KABLO KANALI(YPŞK. BANTLI)(GRİ)	1mt. 40	2mt. 80	100,00
001 008 025060 XX 17	25x60	MEKS DELİKLİ KABLO KANALI(YPŞK. BANTLI)(GRİ)	1mt. 36	2mt. 80	133,33
001 008 040040 XX 17	40x40	MEKS DELİKLİ KABLO KANALI(YPŞK. BANTLI)(GRİ)	1mt. 25	2mt. 50	125,93
001 008 040060 XX 17	40x60	MEKS DELİKLİ KABLO KANALI(YPŞK. BANTLI)(GRİ)	1mt. 24	2mt. 48	151,85
001 008 060040 XX 17	60x40	MEKS DELİKLİ KABLO KANALI(YPŞK. BANTLI)(GRİ)	1mt. 24	2mt. 48	170,37
001 008 060060 XX 17	60x60	MEKS DELİKLİ KABLO KANALI(YPŞK. BANTLI)(GRİ)	1mt. 16	2mt. 32	208,41
001 008 060080 XX 17	60x80	MEKS DELİKLİ KABLO KANALI(YPŞK. BANTLI)(GRİ)	1mt. 12	2mt. 24	255,56
001 008 060100 XX 17	60x100	MEKS DELİKLİ KABLO KANALI(YPŞK. BANTLI)(GRİ)	1mt. 8	2mt. 16	281,48
001 008 040080 XX 17	40x80	MEKS DELİKLİ KABLO KANALI(YPŞK. BANTLI)(GRİ)	1mt. 18	2mt. 36	218,52
001 008 080060 XX 17	80x60	MEKS DELİKLİ KABLO KANALI(YPŞK. BANTLI)(GRİ)	1mt. 12	2mt. 24	262,96
001 008 100060 XX 17	100x60	MEKS DELİKLİ KABLO KANALI(YPŞK. BANTLI)(GRİ)	1mt. 8	2mt. 16	348,15
001 008 100100 XX 17	100x100	MEKS DELİKLİ KABLO KANALI(YPŞK. BANTLI)(GRİ)	1mt. 4	2mt. 8	522,22

### YAPIŞKAN BANTLI MEKS DELİKLİ KABLO KANALLAR (MAVİ)

001 008 025025 XX 13	25x25	MEKS DELİKLİ KABLO KANALI(YPŞK. BANTLI)(MAVİ)	1mt. 64	2mt. 120	81,62
001 008 025040 XX 13	25x40	MEKS DELİKLİ KABLO KANALI(YPŞK. BANTLI)(MAVİ)	1mt. 40	2mt. 80	105,93
001 008 025060 XX 13	25x60	MEKS DELİKLİ KABLO KANALI(YPŞK. BANTLI)(MAVİ)	1mt. 36	2mt. 80	146,67
001 008 040040 XX 13	40x40	MEKS DELİKLİ KABLO KANALI(YPŞK. BANTLI)(MAVİ)	1mt. 25	2mt. 50	134,44
001 008 040060 XX 13	40x60	MEKS DELİKLİ KABLO KANALI(YPŞK. BANTLI)(MAVİ)	1mt. 24	2mt. 48	170,23
001 008 060040 XX 13	60x40	MEKS DELİKLİ KABLO KANALI(YPŞK. BANTLI)(MAVİ)	1mt. 24	2mt. 48	181,48
001 008 060060 XX 13	60x60	MEKS DELİKLİ KABLO KANALI(YPŞK. BANTLI)(MAVİ)	1mt. 16	2mt. 32	225,18
001 008 060080 XX 13	60x80	MEKS DELİKLİ KABLO KANALI(YPŞK. BANTLI)(MAVİ)	1mt. 12	2mt. 24	281,11
001 008 060100 XX 13	60x100	MEKS DELİKLİ KABLO KANALI(YPŞK. BANTLI)(MAVİ)	1mt. 8	2mt. 16	305,56
001 008 040080 XX 13	40x80	MEKS DELİKLİ KABLO KANALI(YPŞK. BANTLI)(MAVİ)	1mt. 18	2mt. 36	262,96
001 008 080060 XX 13	80x60	MEKS DELİKLİ KABLO KANALI(YPŞK. BANTLI)(MAVİ)	1mt. 12	2mt. 24	313,70
001 008 100060 XX 13	100x60	MEKS DELİKLİ KABLO KANALI(YPŞK. BANTLI)(MAVİ)	1mt. 8	2mt. 16	403,33
001 008 100100 XX 13	100x100	MEKS DELİKLİ KABLO KANALI(YPŞK. BANTLI)(MAVİ)	1mt. 4	2mt. 8	582,59

Ürün Kodu	Ölçü (mm)	Ürün Adı	Ambalaj Kutu /Adet	Fiyat (₺)
-----------	-----------	----------	--------------------	-----------

### KABLO TUTUCU APARATI

001 050 010001 00 00	25x40	KABLO TUTUCU APARATI	50	43,30
001 050 010002 00 00	40x40	KABLO TUTUCU APARATI	50	43,30
001 050 010003 00 00	60x40	KABLO TUTUCU APARATI	50	43,30

### KABLO TUTUCU YAN APARATI

001 050 020001 00 00	40X40/60	KABLO TUTUCU YAN APARATI	100	14,50
001 050 020002 00 00	60X40/60	KABLO TUTUCU YAN APARATI	100	14,50
001 050 020004 00 00	100X60	KABLO TUTUCU YAN APARATI	100	25,50



# MEKSPLUS<sup>+</sup> PANO



ZORLU ŞARTLAR İÇİN  
MAKSİMUM KORUMA

## MEKSPLUS OPAK KAPAKLI ABS PANOLAR

Ürün Kodu	Ölçü (cm)	Ürün Adı	Ağırlık (kg)	Adet	Fiyat (₺)
048 096 203013	20X30X13	MEKSPLUS PLASTİK OPAK KAPAKLI PANO IP67	1.64	1	1,321.63
048 096 253515	25X35X15	MEKSPLUS PLASTİK OPAK KAPAKLI PANO IP67	2.29	1	1,735.72
048 096 304017	30X40X17	MEKSPLUS PLASTİK OPAK KAPAKLI PANO IP67	3.13	1	2,149.81
048 096 405018	40X50X17,5	MEKSPLUS PLASTİK OPAK KAPAKLI PANO IP67	4.90	1	3,152.25
048 096 405024	40X50X24	MEKSPLUS PLASTİK OPAK KAPAKLI PANO IP67	5.52	1	3,618.10
048 096 406020	40X60X20	MEKSPLUS PLASTİK OPAK KAPAKLI PANO IP67	6.30	1	3,647.43

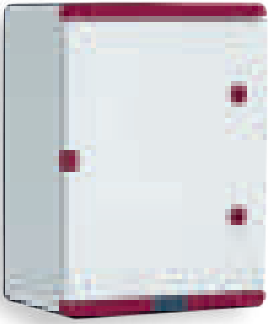

## MEKS PLUS ŞEFFAF KAPAKLI ABS PANOLAR

Ürün Kodu	Ölçü (cm)	Ürün Adı	Ağırlık (kg)	Adet	Fiyat (₺)
048 097 203013	20X30X13	MEKSPLUS PLASTİK ŞEFFAF KAPAKLI PANO IP67	1.68	1	1,433.78
048 097 253515	25X35X15	MEKSPLUS PLASTİK ŞEFFAF KAPAKLI PANO IP67	2.29	1	1,847.87
048 097 304017	30X40X17	MEKSPLUS PLASTİK ŞEFFAF KAPAKLI PANO IP67	3.13	1	2,248.16
048 097 405018	40X50X17,5	MEKSPLUS PLASTİK ŞEFFAF KAPAKLI PANO IP67	5.06	1	3,581.87
048 097 405024	40X50X24	MEKSPLUS PLASTİK ŞEFFAF KAPAKLI PANO IP67	5.57	1	4,077.05
048 097 406020	40X60X20	MEKSPLUS PLASTİK ŞEFFAF KAPAKLI PANO IP67	6.37	1	4,189.20

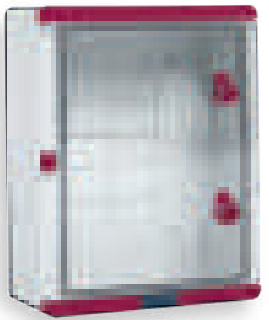



IP65 CE

## PROMEX OPAK KAPAKLI ABS PANOLAR - HALOGEN FREE

Ürün Kodu	Ölçü (cm)	Ürün Adı	Ağırlık (kg)	Adet	Fiyat (₺)
001 046 203013 00 17	20x30x13	PROMEX PLASTİK OPAK KAPAKLI PANO	1,70	1	888,89
001 046 253515 00 17	25x35x15	PROMEX PLASTİK OPAK KAPAKLI PANO	2,20	1	1.129,63
001 046 304017 00 17	30x40x17	PROMEX PLASTİK OPAK KAPAKLI PANO	3,00	1	1.518,52
001 046 304022 00 17	30x40x22	PROMEX PLASTİK OPAK KAPAKLI PANO	3,40	1	1.814,81
001 046 355019 00 17	35x50x19	PROMEX PLASTİK OPAK KAPAKLI PANO	4,30	1	2.229,63
001 046 405018 00 17	40x50x18	PROMEX PLASTİK OPAK KAPAKLI PANO	4,30	1	2.359,26
001 046 405024 00 17	40x50x24	PROMEX PLASTİK OPAK KAPAKLI PANO	5,60	1	2.777,78
001 046 406020 00 17	40x60x20	PROMEX PLASTİK OPAK KAPAKLI PANO	6,00	1	2.870,37
001 046 507025 00 17	50x70x25	PROMEX PLASTİK OPAK KAPAKLI PANO	10,10	1	4.548,15
001 046 608026 00 17	60x80x26	PROMEX PLASTİK OPAK KAPAKLI PANO	13,50	1	7.407,41

## PROMEX ŞEFFAF KAPAKLI ABS PANOLAR - HALOGEN FREE

Ürün Kodu	Ölçü (cm)	Ürün Adı	Ağırlık (kg)	Adet	Fiyat (₺)
001 046 203013 00 44	20x30x13	PROMEX PLASTİK ŞEFFAF KAPAKLI PANO	1,70	1	925,93
001 046 253515 00 44	25x35x15	PROMEX PLASTİK ŞEFFAF KAPAKLI PANO	2,20	1	1.222,22
001 046 304017 00 44	30x40x17	PROMEX PLASTİK ŞEFFAF KAPAKLI PANO	3,00	1	1.629,63
001 046 304022 00 44	30x40x22	PROMEX PLASTİK ŞEFFAF KAPAKLI PANO	3,40	1	1.888,89
001 046 355019 00 44	35x50x19	PROMEX PLASTİK ŞEFFAF KAPAKLI PANO	4,30	1	2.407,41
001 046 405018 00 44	40x50x18	PROMEX PLASTİK ŞEFFAF KAPAKLI PANO	4,30	1	2.592,59
001 046 405024 00 44	40x50x24	PROMEX PLASTİK ŞEFFAF KAPAKLI PANO	5,60	1	3.074,07
001 046 406020 00 44	40x60x20	PROMEX PLASTİK ŞEFFAF KAPAKLI PANO	6,00	1	3.148,15
001 046 507025 00 44	50x70x25	PROMEX PLASTİK ŞEFFAF KAPAKLI PANO	10,10	1	5.000,00
001 046 608026 00 44	60x80x26	PROMEX PLASTİK ŞEFFAF KAPAKLI PANO	13,50	1	7.777,78



IP65 CE

## PROMEX OPAK KAPAKLI ABS OTOMAT PANOLAR - HALOGEN FREE

Ürün Kodu	Ölçü (cm)	Ürün Adı	Ağırlık (kg)	Adet	Fiyat (₺)
001 046 253515 01 17	25x35x15	PROMEX 18 OTOMATLI (9x2)	2,50	1	2.441,49
001 046 304017 01 17	30x40x17	PROMEX 24 OTOMATLI (12x2)	3,40	1	2.797,41
001 046 355019 01 17	35x50x19	PROMEX 45 OTOMATLI (15x3)	4,50	1	3.668,63
001 046 406020 01 17	40x60x20	PROMEX 60 OTOMATLI (15x4)	6,00	1	4.483,27



IP65 CE

## PROMEX ŞEFFAF KAPAKLI ABS OTOMAT PANOLAR - - HALOGEN FREE

Ürün Kodu	Ölçü (cm)	Ürün Adı	Ağırlık (kg)	Adet	Fiyat (₺)
001 046 253515 01 44	25x35x15	PROMEX 18 OTOMATLI (9x2)	2,50	1	2.456,49
001 046 304017 01 44	30x40x17	PROMEX 24 OTOMATLI (12x2)	3,40	1	2.800,90
001 046 355019 01 44	35x50x19	PROMEX 45 OTOMATLI (15x3)	4,50	1	3.689,12
001 046 406020 01 44	40x60x20	PROMEX 60 OTOMATLI (15x4)	6,00	1	4.706,42



## GALVANİZ TABAN SAÇLARI

Ürün Kodu	Ölçü (mm)	Ürün Adı	Adet	Fiyat (₺)
000 702 203013 00 00	20x30x13	GALVANİZ TABAN SAÇI 1mm	1	172,14
000 702 253515 00 00	25x35x15	GALVANİZ TABAN SAÇI 1mm	1	191,61
000 702 304017 00 00	30x40x17	GALVANİZ TABAN SAÇI 1mm	1	249,61
000 702 304022 00 00	30x40x22	GALVANİZ TABAN SAÇI 1mm	1	256,24
000 702 355019 00 00	35x50x19	GALVANİZ TABAN SAÇI 1mm	1	362,12
000 702 405018 00 00	40x50x17,5	GALVANİZ TABAN SAÇI 1mm	1	432,53
000 702 405024 00 00	40x50x24	GALVANİZ TABAN SAÇI 1mm	1	423,02
000 702 406020 00 00	40x60x20	GALVANİZ TABAN SAÇI 1mm	1	514,97
000 702 507025 00 00	50x70x25	GALVANİZ TABAN SAÇI 1mm	1	734,78



## MODÜLER KİTLER ve SEPERATÖRLER

Ürün Kodu	Ölçü (mm)	Ürün Adı	Adet	Fiyat (₺)
000 700 253515 01 17	25X35X15	18 OTOMATLI (9X2)	1	1.407,41
000 700 304017 01 17	30X40X17	24 OTOMATLI (12X2)	1	1.629,63
000 700 355019 01 17	35X50X19	45 OTOMATLI (15X3)	1	2.222,22
000 700 406020 01 17	40X60X20	60 OTOMATLI (15X4)	1	2.296,30
000 700 253515 00 17	25X35X15	PLASTİK PERDE	1	203,70
000 700 304017 00 17	30X40X17	PLASTİK PERDE	1	259,26
000 700 355019 00 17	35X50X19	PLASTİK PERDE	1	425,93
000 700 406020 00 17	40X60X20	PLASTİK PERDE	1	462,96



000 705 000720 00 00



000 700 000710 00 17



000 700 000711 00 17



000 700 000712 00 17



000 705 000721 00 00

## PANO AKSESUARLARI

Ürün Kodu	Ürün Adı	Adet	Fiyat (₺)
000 705 000720 00 00	PANO KİLİT GÖBEK TAKIMI (SET)	1	74,07
000 700 000710 00 17	PANO DUVAR MONTAJ APARATI	1	25,93
000 700 000711 00 17	PANO ÜÇGEN ANAHTAR	1	25,93
000 700 000712 00 17	PANO SEPERATÖRÜ TUTTURMA VİDASI	1	37,04
000 705 000721 00 00	PLASTİK KİLİTLENEBİLİR PANO (METAL) KİLİDİ	1	555,56

## Ray Tipi Pano Prizleri



### RAY TİPİ PANO PRİZLERİ



ÜRÜN KODU	010 104 000157
ÜRÜN ADI	MRP-16 1x16 RAY TİPİ PANO PRİZİ
AMB. AD./KOLİ	10
FİYAT (₺)	146,70



ÜRÜN KODU	010 104 000158
ÜRÜN ADI	MRP-LED 10x16 RAY TİPİ PANO PRİZİ - LEDLİ
AMB. AD./KOLİ	10
FİYAT (₺)	227,70



ÜRÜN KODU	010 104 000159
ÜRÜN ADI	MRP-UPS 1X16 RAY TİPİ PANO PRİZİ - UPS
AMB. AD./KOLİ	10
FİYAT (₺)	227,70

# ENERJİ TASARRUFU SAĞLAR

Doğru sıcaklık değerini korumak için ısıtma veya soğutma cihazlarını açıp kapatarak veya bir ısı transfer sıvısının akışını gerektiği gibi düzenleyerek kontrol yapar.



## DİJİTAL TERMOSTAT ve HİGROSTAT

Teknik Veriler İçin Okutunuz



ÜRÜN ADI	PDT 50-150 SICAKLIK KONTROL CİHAZI
ÜRÜN KODU	048 095 000304
ADET	1
FİYAT	210,83 \$

\* NOT: PTC SENSÖR CİHAZ DAHİLİNDEDİR.



ÜRÜN ADI	HT-310 SICAKLIK VE NEM KONTROL CİHAZI
ÜRÜN KODU	048 095 000305
ADET	1
FİYAT	210,83 \$

\* NOT: SICAKLIK VE NEM SENSÖRÜ CİHAZ DAHİLİNDEDİR.

## PROMEX SERİSİ

### TERMOSTAT ve HİGROSTAT



#### ISITMA TERMOSTAT - NK

ÜRÜN KODU	048 095 000300
AYAR SAHASI	0-60°C
KONTAK TİPİ	NK
KORUMA SINIFI	IP20
AĞIRLIK	45 GR
ADET / KOLİ	135
FİYAT	9,80 \$



#### SOĞUTMA TERMOSTAT - NA

ÜRÜN KODU	048 095 000301
AYAR SAHASI	0-60°C
KONTAK TİPİ	NA
KORUMA SINIFI	IP20
AĞIRLIK	45 GR
ADET / KOLİ	135
FİYAT	9,80 \$



#### DUAL TERMOSTAT - NK+NA

ÜRÜN KODU	048 095 000302
AYAR SAHASI	0-60°C / 0-60°C
KONTAK TİPİ	NK+NA
KORUMA SINIFI	IP20
AĞIRLIK	80 GR
ADET / KOLİ	60
FİYAT	19,59 \$



#### MEKANİK HİGROSTAT - 1CO

ÜRÜN KODU	048 095 000303
AYAR SAHASI	%10-90RH
KONTAK TİPİ	1CO
KORUMA SINIFI	IP20
AĞIRLIK	180 GR
ADET / KOLİ	30
FİYAT	83,27 \$



Teknik Veriler İçin  
Okutunuz

## EKOFAN SERİSİ

### TERMOSTAT ve HİGROSTAT



#### SOĞUTUCU TERMOSTAT

ÜRÜN KODU	048 095 101141
AYAR SAHASI	0-60°C
KONTAK TİPİ	NO
KORUMA SINIFI	IP20
AĞIRLIK	45 GR
ADET / KOLİ	1
FİYAT	6,79 \$



#### ISITICI TERMOSTAT

ÜRÜN KODU	048 095 101140
AYAR SAHASI	0-60°C
KONTAK TİPİ	NC
KORUMA SINIFI	IP20
AĞIRLIK	45 GR
ADET / KOLİ	1
FİYAT	6,79 \$



#### MULTİ TERMOSTAT

ÜRÜN KODU	048 095 101142
AYAR SAHASI	0-60°C / 0-60°C
KONTAK TİPİ	NC+NO
KORUMA SINIFI	IP20
AĞIRLIK	80 GR
ADET / KOLİ	1
FİYAT	23,43 \$



#### HİGROSTAT

ÜRÜN KODU	048 095 101143
AYAR SAHASI	%40-90RH
KONTAK TİPİ	1CO
KORUMA SINIFI	IP20
AĞIRLIK	180 GR
ADET / KOLİ	1
FİYAT	70,28 \$



#### ODA TERMOSTAT

ÜRÜN KODU	048 095 101144
AYAR SAHASI	%10-90RH
KONTAK TİPİ	1CO
KORUMA SINIFI	IP20
AĞIRLIK	180 GR
ADET / KOLİ	1
FİYAT	74,96 \$

## PROMEX SERİSİ TEPE FANLARI



IP54



Poliüretan Conta



Radyal Fan



VO Alev İletmez ABS

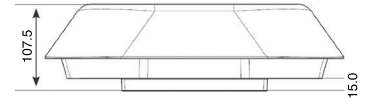
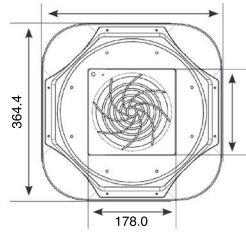

## PROMEX TEPE FANLARI

Ürün Kodu	Fan Tipi	Besleme	Güç (W)	Nominal Akım	Gürültü Seviyesi	Kapasite	Adet	Fiyat
048 095 000100	Ø172x163x51 AKSIYEL	220V AC 50/60 Hz	25/32W	0,11/0,15A	57 dB	400 m³/h	1	93,70 \$
048 095 000101	Ø190x68 RADYAL	220V AC 50/60 Hz	58/75W	0,26/0,34A	62 dB	560 m³/h	1	187,41 \$
048 095 000102	Ø220x71 RADYAL	220V AC 50/60 Hz	85/90W	0,38/0,44A	73 dB	970 m³/h	1	210,83 \$



Vidasız hızlı ve kolay montaj !



IP54



Poliüretan Conta



Radyal Fan



VO Alev İletmez ABS



Hızlı ve Kolay Montaj

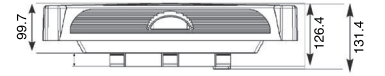
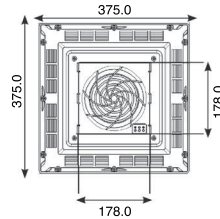

Ürün Kodu	Fan Tipi	Besleme	Güç (W)	Nominal Akım	Gürültü Seviyesi	Kapasite	Adet	Fiyat
048 095 000200	Ø172x163x51 AKSIYEL	220V AC 50/60 Hz	25/32W	0,11/0,15A	57 dB	400 m³/h	1	93,70 \$
048 095 000201	Ø190x68 RADYAL	220V AC 50/60 Hz	58/75W	0,26/0,34A	62 dB	560 m³/h	1	187,41 \$
048 095 000202	Ø220x71 RADYAL	220V AC 50/60 Hz	85/90W	0,38/0,44A	73 dB	970 m³/h	1	210,83 \$

## EKOFAN SERİSİ TEPE FANLARI



## EKOFAN TEPE FANLARI

Ürün Kodu	Fan Tipi	Besleme	Güç (W)	Nominal Akım	Gürültü Seviyesi	Kapasite	Adet	Fiyat (\$)
048 095 100100	MTF300	230V AC 50/60 Hz	35W	0,15A	51 dB	300 m³/h	1	131,19 \$
048 095 100101	MTF 600	230V AC 50/60 Hz	65W	0,30A	60 dB	634 m³/h	1	159,30 \$
048 095 100102	MTF 900	230V AC 50/60 Hz	90W	0,48A	60 dB	900 m³/h	1	173,35 \$
048 095 100103	MTF 1200	230V AC 50/60 Hz	90W	0,48A	90 dB	1200 m³/h	1	187,41 \$



## KOLAY MONTAJ FİLTRELER

Ürün Kodu	Ölçü (mm)	Kesim Ölçüsü (mm)	Koruma Sınıfı	Adet / Koli	Fiyat (\$)
048 095 000400	120x120x20,5	92x92	IP54	200	4,69 \$
048 095 000401	160x160x31	125x125	IP54	100	7,96 \$
048 095 000402	210x210x31	177x177	IP54	100	11,71 \$
048 095 000403	260x260x31	223x223	IP54	100	16,40 \$
048 095 000404	325x325x31	291x291	IP54	100	32,80 \$

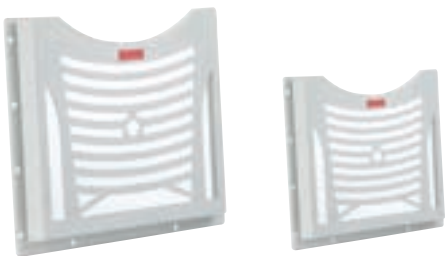

## PROJE CEPLERİ

Ürün Kodu	Ürün Adı	Adet / Koli	Fiyat (\$)
048 095 000902	PROJE CEBİ A4	1	5,14 \$
048 095 000903	PROJE CEBİ A5	1	4,03 \$

## FİLTRELİ FANLAR



048 095 000500



048 095 000501



048 095 000502

ÜRÜN KODU	048 095 000500	048 095 000501	048 095 000502
ÖLÇÜ (mm)	120x120x58,5	160x160x69	120x120x58,5
KESİM ÖLÇÜSÜ (mm)	92x92	125x125	92x92
FAN TİPİ	80x80x38	120x120x38	80x80x38
BESLEME (V AC)	230V-50/60Hz	230V-50/60Hz	230V-50/60Hz
GÜÇ (W)	14 (13)	26 (23)	14 (13)
HIZ (rpm)	2800	2700	2800
FİLTRELİ (m <sup>3</sup> /h)	30	100	30
FİLTRESİZ (m <sup>3</sup> /h)	41	140	41
NOMİNAL AKIM	0,08 / 0,07	0,14 / 0,13	0,8 / 0,7
GÜRÜLTÜ SEVİYESİ (db)	28 (31)	42 (46)	28 (31)
AD. / FİYAT	28,11 \$	37,48 \$	42,17 \$



048 095 000600



048 095 000601



048 095 000602



048 095 000603

ÜRÜN KODU	048 095 000600	048 095 000601	048 095 000602	048 095 000603
ÖLÇÜ (mm)	160x160x69	210x210x98	210x210x83	260x260x103
KESİM ÖLÇÜSÜ (mm)	125x125	177x177	177x177	223x223
FAN TİPİ	120x120x38	120x120x38	173x163x51	120x120x38
BESLEME (V AC)	230V-50/60Hz	230V-50/60Hz	230V-50/60Hz	230V-50/60Hz
GÜÇ (W)	26 (23)	26 (23)	37 (35)	26 (23)
HIZ (rpm)	2700	2700	2400	2700
FİLTRELİ (m <sup>3</sup> /h)	100	125	175	115
FİLTRESİZ (m <sup>3</sup> /h)	140	175	245	130
NOMİNAL AKIM	0,14 / 0,13	0,14 / 0,13	0,23 / 0,22	0,14 / 0,13
GÜRÜLTÜ SEVİYESİ (db)	42 (46)	42 (46)	52 (53)	42 (46)
AD. / FİYAT	46,85 \$	65,59 \$	70,28 \$	84,33 \$



048 095 000604



048 095 000605



048 095 000606



048 095 000607

ÜRÜN KODU	048 095 000604	048 095 000605	048 095 000606	048 095 000607
ÖLÇÜ (mm)	260x260x116	260x260x111	325x325x145	325x325x111
KESİM ÖLÇÜSÜ (mm)	223x223	223x223	291x291	291x291
FAN TİPİ	172x163x51	225x225x80	225x225x80	280x280x80
BESLEME (V AC)	230V-50/60Hz	230V-50/60Hz	230V-50/60Hz	230V-50/60Hz
GÜÇ (W)	37 (35)	66 (75)	66 (75)	110 (140)
HIZ (rpm)	2400	2600	2600	2600
FİLTRELİ (m <sup>3</sup> /h)	240	650	700	850
FİLTRESİZ (m <sup>3</sup> /h)	270	900	950	1200
NOMİNAL AKIM	0,23 / 0,22	0,35 / 0,38	0,35 / 0,38	0,50 / 0,72
GÜRÜLTÜ SEVİYESİ (db)	52 (53)	60 (63)	60 (63)	65 (68)
AD. / FİYAT	93,70 \$	234,26 \$	257,69 \$	281,11 \$



MİNİ ISITICI



PTC ISITICI



SLİM ISITICI

## PANO ISITICILARI

Ürün Kodu	Ürün Adı	Besleme	Koruma Sınıfı	Ölçüler (AxBxC)mm	Bağlantı	Adet	Fiyat (\$)
048 095 000700	15W PTC PANO ISITICISI	100-250V AC-DC	IP20	60x50x27	KABLO	1	32,80 \$
048 095 000701	25W PTC PANO ISITICISI	100-250V AC-DC	IP20	70x50x27	KABLO	1	37,48 \$
048 095 000702	30W PTC PANO ISITICISI	100-250V AC-DC	IP20	128x70x59	KLEMENS	1	56,22 \$
048 095 000703	50W PTC PANO ISITICISI	100-250V AC-DC	IP20	138x70x59	KLEMENS	1	65,59 \$
048 095 000704	75W PTC PANO ISITICISI	100-250V AC-DC	IP20	178x70x59	KLEMENS	1	79,65 \$
048 095 000705	100W PTC PANO ISITICISI	100-250V AC-DC	IP20	188x70x59	KLEMENS	1	93,70 \$
048 095 000706	150W PTC PANO ISITICISI	100-250V AC-DC	IP20	228x70x59	KLEMENS	1	112,44 \$
048 095 000707	30W SLİM PTC PANO ISITICISI	100-250V AC-DC	IP20	128x27x80	KLEMENS	1	56,22 \$
048 095 000708	50W SLİM PTC PANO ISITICISI	100-250V AC-DC	IP20	138x27x80	KLEMENS	1	65,59 \$
048 095 000709	75W SLİM PTC PANO ISITICISI	100-250V AC-DC	IP20	178x27x80	KLEMENS	1	79,65 \$
048 095 000710	100W SLİM PTC PANO ISITICISI	100-250V AC-DC	IP20	188x27x80	KLEMENS	1	93,70 \$
048 095 000711	150W SLİM PTC PANO ISITICISI	100-250V AC-DC	IP20	228x27x80	KLEMENS	1	112,44 \$



FANLI PTC ISITICI



FANLI ISITICI



400W PLASTİK FANLI ISITICI

## FANLI PANO ISITICILARI

Ürün Kodu	Ürün Adı	Besleme	Koruma Sınıfı	Ölçüler (AxBxC)mm	Bağlantı	Adet	Fiyat (\$)
048 095 000800	100W FANLI PTC PANO ISITICISI	230V AC 50/60 Hz	IP20	170x89x60	KLEMENS	1	187,41 \$
048 095 000801	150W FANLI PTC PANO ISITICISI	230V AC 50/60 Hz	IP20	210x89x60	KLEMENS	1	210,83 \$
048 095 000802	250W FANLI REZİSTANS PANO ISITICISI	230V AC 50/60 Hz	IP20	152x110x80	KLEMENS	1	234,26 \$
048 095 000803	500W FANLI REZİSTANS PANO ISITICISI	230V AC 50/60 Hz	IP20	182x110x80	KLEMENS	1	243,63 \$
048 095 000804	750W FANLI REZİSTANS PANO ISITICISI	230V AC 50/60 Hz	IP20	232x110x80	KLEMENS	1	281,11 \$
048 095 000805	200/300/400W FANLI PTC PANO ISITICISI	230V AC 50/60 Hz	IP20	99x70x67	KABLO	1	257,69 \$

# YENİ

## Güvenilir, kolay ve hızlı bağlantılar...

- Titreşimli Alanlarda Mükemmel Bağlantı
- Aletsiz Kablolama
- Kompakt Boyut
- Kablolama Süresinden %75 Tasarruf
- Yüksek Çekme Kuvveti

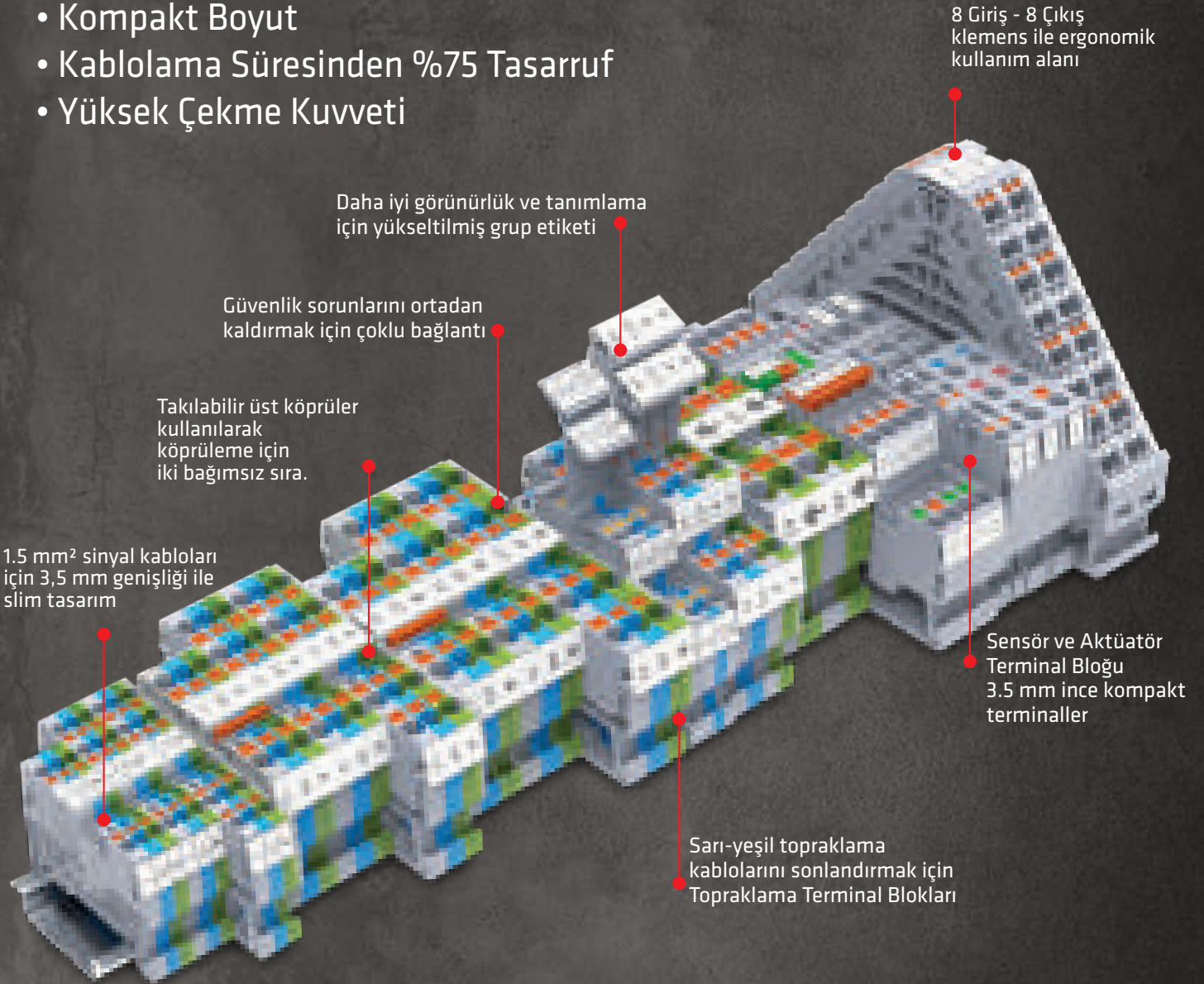

YENİ NESİL

**Promex**  
PUSH-IN TİP  
RAY KLEMENSLER



## PROMEX SERİSİ PUSH-IN TİP RAY KLEMENSLER

	Ürün Kodu	Ürün Adı	Gerilim / Akım V/A	Kutu Adedi	Fiyat (\$)
	065 095 0XX015	<b>MP1.5</b> 1,5 mm Ray Klemens Push-In Tip	800V 15A	100	0,80 \$
	065 095 0XX025	<b>MP2.5</b> 2,5 mm Ray Klemens Push-In Tip	1000V 24A	100	0,83 \$
	065 095 0XX004	<b>MP4</b> 4 mm Ray Klemens Push-In Tip	1000V 32A	100	1,10 \$
	065 095 0XX010	<b>MP6/10</b> 6/10 mm Ray Klemens Push-In Tip	1000V 57A	100	2,33 \$
	065 095 417015	<b>MP1.5/3</b> 1,5 mm 1 Giriş 2 Çıkış Ray Klemens Push-In Tip	800V 15A	100	1,29 \$
	065 095 217015	<b>MP1.5/4</b> 1,5 mm 2 Giriş 2 Çıkış Ray Klemens Push-In Tip	800V 15A	100	1,50 \$
	065 095 4XX025	<b>MP2.5/3</b> 2,5 mm 1 Giriş 2 Çıkış Ray Klemens Push-In Tip	1000V 24A	100	1,63 \$
	065 095 2XX025	<b>MP2.5/4</b> 2,5 mm 2 Giriş 2 Çıkış Ray Klemens Push-In Tip	1000V 24A	100	2,00 \$
	065 095 117025	<b>MPDL2.5</b> 2,5 mm Çift Katlı 2 Giriş 2 Çıkış Ray Klemens Push-In Tip	1000V 24A	50	2,03 \$
	065 095 4XX004	<b>MP4/3</b> 4 mm 1 Giriş 2 Çıkış Ray Klemens Push-In Tip	1000V 32A	50	2,07 \$
	065 095 2XX004	<b>MP4/4</b> 4 mm 2 Giriş 2 Çıkış Ray Klemens Push-In Tip	1000V 32A	50	2,50 \$
	065 095 4XX010	<b>MP6/10/3</b> 6/10 mm 1 Giriş 2 Çıkış Ray Klemens Push-In Tip	1000V 57A	50	4,50 \$

\*HER ÜRÜNDE TÜM RENKLER MEVCUT DEĞİLDİR. RENK SEÇENEKLERİ İÇİN ÜRÜNÜN TEKNİK KATALOĞUNA BAKINIZ.

### XX KARŞILIĞI OLAN RENK KODLARI



00  
BEYAZ



11  
SİYAH



12  
TURUNCU



13  
MAVİ



15  
YEŞİL



16  
KIRMIZI









17  
GRİ

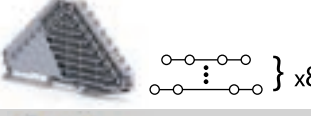
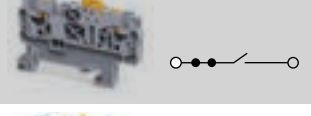

21  
KAHVERENGİ

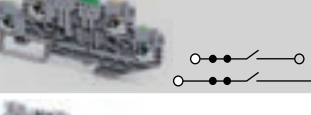
## PROMEX SERİSİ PUSH-IN TİP RAY KLEMENSLER

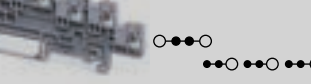
	Ürün Kodu	Ürün Adı	Gerilim / Akım V/A	Kutu Adedi	Fiyat (\$)
	065 095 317025	<b>MPTL2.5</b> 2,5 mm Üç Katlı 2 Giriş 2 Çıkış Ray Klemens Push-In Tip	500V 24A	50	5.00 \$
	065 095 617015	<b>MP4L16</b> 1,5 mm Dört Katlı 2 Giriş 2 Çıkış Ray Klemens Push-In Tip	320V 8A	10	38.33 \$
	065 095 817015	<b>MP8L32</b> 1,5 mm Sekiz Katlı 2 Giriş 2 Çıkış Ray Klemens Push-In Tip	320V 8A	10	51.00 \$
	065 095 017030	<b>MPK2.5</b> 2,5 mm Ayırma Test Klemensi Push-In Tip	1000V 20A	100	4.33 \$
	065 095 017032	<b>MPK4</b> 4 mm Ayırma Test Klemensi Push-In Tip	1000V 20A	50	5.17 \$
	065 095 117030	<b>MPDLK2.5</b> 2,5 mm Çift Katlı Ayırma Klemensi Push-In Tip	500V 16A	50	14.33 \$
	065 095 017034	<b>MPST1.5/3</b> 1,5 mm Sensör ve Aktüatör Klemensi Push-In Tip	250V 13.5A	50	9.67 \$
	065 095 017036	<b>MPST1.5/4</b> 1,5 mm Sensör ve Aktüatör Klemensi Push-In Tip	250V 13.5A	50	12.00 \$

## PROMEX SERİSİ TOPRAKLAMALI PUSH-IN TİP RAY KLEMENSLER

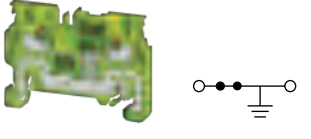
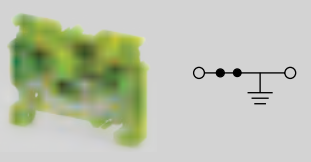
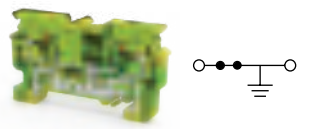
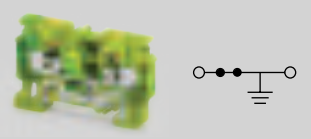
	Ürün Kodu	Ürün Adı	Kutu Adedi	Fiyat (\$)
	065 095 345015	<b>MPG1.5</b> 1,5 mm Ray Klemens Topraklama Push-In Tip Sarı-Yeşil	100	2,75 \$
	065 095 345025	<b>MPG2.5</b> 2,5 mm Ray Klemens Topraklama Push-In Tip Sarı-Yeşil	100	2,89 \$
	065 095 345004	<b>MPG4</b> 4 mm Ray Klemens Topraklama Push-In Tip Sarı-Yeşil	100	3,67 \$
	065 095 345010	<b>MPG6/10</b> 6/10 mm Ray Klemens Topraklama Push-In Tip Sarı-Yeşil	100	5,14 \$

# YENİ



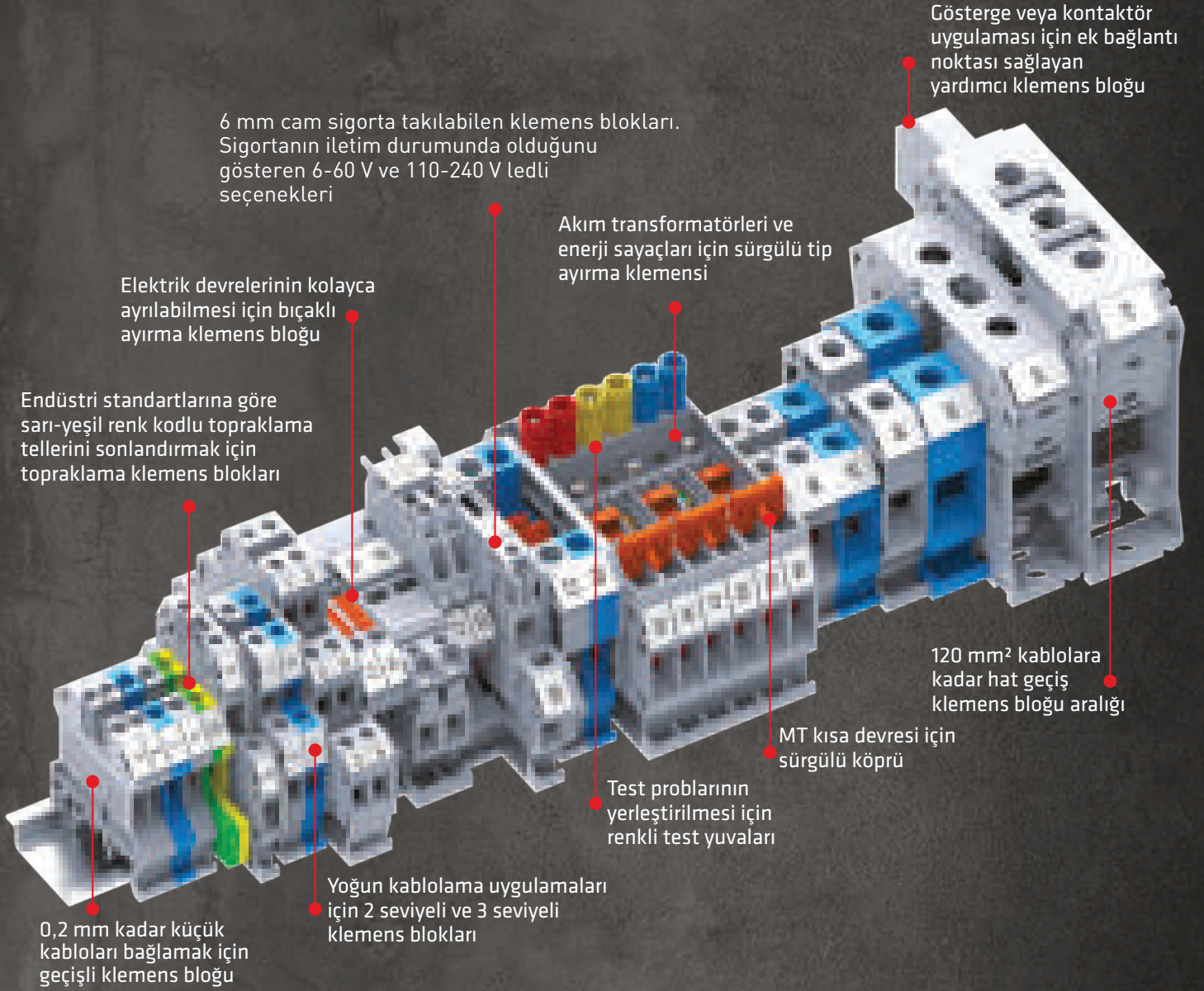















## Güvenli ve Hızlı Bağlantılara Hazır Olun...



**Promex**  
VİDALI TİP  
RAY KLEMENSLER



## PROMEX SERİSİ VİDALI TİP RAY KLEMENSLER

	Ürün Kodu	Ürün Adı	Gerilim / Akım V/A	Kutu Adedi	Fiyat (\$)
 	065 094 OXX025	<b>MTS2.5UN</b> 2,5 mm Ray Klemens Vidalı Tip	1000V 24A	100	0,60 \$
 	065 094 OXX004	<b>MTS4UN</b> 4 mm Ray Klemens Vidalı Tip	1000V 32A	100	0,74 \$
 	065 094 OXX006	<b>MTS6U</b> 6 mm Ray Klemens Vidalı Tip	1000V 41A	100	1,08 \$
 	065 094 OXX010	<b>MTS10U</b> 10 mm Ray Klemens Vidalı Tip	1000V 57A	100	1,35 \$
 	065 094 OXX016	<b>MTS16U</b> 16 mm Ray Klemens Vidalı Tip	1000V 76A	50	2,08 \$
 	065 094 OXX026	<b>MTS25U</b> 25 mm Ray Klemens Vidalı Tip	1000V 101A	50	3,50 \$
 	065 094 OXX035	<b>MTS35U</b> 35 mm Ray Klemens Vidalı Tip	1000V 125A	50	4,33 \$
 	065 094 OXX070	<b>MTS50/70N</b> 50/70 mm Ray Klemens Vidalı Tip	1000V 192A	20	15,67 \$
 	065 094 OXX120	<b>MTS95/120N</b> 95/120 mm Ray Klemens Vidalı Tip	1000V 269A	10	23,33 \$

\*HER ÜRÜNDE TÜM RENKLER MEVCUT DEĞİLDİR. RENK SEÇENEKLERİ İÇİN ÜRÜNÜN TEKNİK KATALOĞUNA BAKINIZ.

### XX KARŞILIĞI OLAN RENK KODLARI



00  
BEYAZ



11  
SİYAH



12  
TURUNCU



13  
MAVİ



15  
YEŞİL



16  
KIRMIZI







17  
GRİ





21  
KAHVERENGİ

















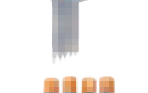

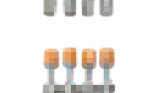
## PROMEX SERİSİ VİDALI TİP RAY KLEMENSLER

	Ürün Kodu	Ürün Adı	Gerilim / Akım V/A	Kutu Adedi	Fiyat (\$)
	065 094 017150	<b>MPTB120/150</b> 120/150 mm Ray Klemens Vidalı tip	1000V 310A	5	30,00 \$
	065 094 017240	<b>MPTB185/240</b> 185/240 mm Ray Klemens Vidalı tip	1000V 420A	2	50,00 \$
	065 094 417025	<b>MMC1-2</b> 2,5 mm 1 Giriş 2 Çıkış Ray Klemens Vidalı Tip	630V 32A	100	1,09 \$
	065 094 217025	<b>MMC2-2</b> 2,5 mm 2 Giriş 2 Çıkış Ray Klemens Vidalı Tip	630V 32A	50	1,33 \$
	065 094 117004	<b>MDL4UN</b> 4 mm Çift Katlı 2 Giriş 2 Çıkış Ray Klemens Vidalı Tip	800V 32A	100	2,33 \$

## PROMEX SERİSİ TOPRAKLAMALI VİDALI TİP RAY KLEMENSLER

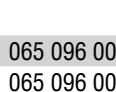
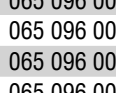
	Ürün Kodu	Ürün Adı	Kutu Adedi	Fiyat (\$)
	065 094 345025	<b>MTSG2.5</b> 2,5 mm Ray Klemens Topraklama Vidalı Tip Sarı-Yeşil	50	2,67 \$
	065 094 345004	<b>MTSG4</b> 4 mm Ray Klemens Topraklama Vidalı Tip Sarı-Yeşil	50	3,00 \$
	065 094 345006	<b>MGT6N</b> 6 mm Ray Klemens Topraklama Vidalı Tip Sarı-Yeşil	50	3,33 \$
	065 094 345010	<b>MGT10N</b> 10 mm Ray Klemens Topraklama Vidalı Tip Sarı-Yeşil	50	4,17 \$
	065 094 345016	<b>MGT16N</b> 16 mm Ray Klemens Topraklama Vidalı Tip Sarı-Yeşil	50	6,00 \$
	065 094 345035	<b>MGT35U</b> 35 mm Ray Klemens Topraklama Vidalı Tip Sarı-Yeşil	20	11,00 \$
	065 094 345070	<b>MGT50/70N</b> 50/70 mm Ray Klemens Topraklama Vidalı Tip Sarı-Yeşil	20	30,00 \$

## PROMEX SERİSİ RAY KLEMENSLER İÇİN AKSESUARLAR

	Ürün Kodu	Ürün Adı	Kutu Adedi	Fiyat (\$)		Ürün Kodu	Ürün Adı	Kutu Adedi	Fiyat (\$)
	065 095 017038	<b>MPA</b> Sigortalı Klemens Push-in Tip 1000V / 30A	50	24,50 \$		065 096 000114	<b>MEPX2.5/4</b> 2,5 ve 4 mm için Yan Kapak Vidalı Tip	50	0,50 \$
	065 096 000062	<b>MF4U</b> Sigortalı Klemens 800V / 6,3A	100	3,17 \$		065 096 000074	<b>MEP6/10</b> 6 ve 10 mm için Yan Kapak Vidalı Tip	50	0,63 \$
	065 096 000064	<b>MF4UL6</b> Sigortalı Klemens Ledli 60 - 6 V AC/DC	100	3,83 \$		065 096 000116	<b>MEPC1.5</b> 1,5 mm için Yan Kapak Push-in Tip	50	0,60 \$
	065 096 000066	<b>MF4UL11</b> Sigortalı Klemens Ledli 220V 240-110V AC/DC	100	6,00 \$		065 096 000052	<b>MEPCX2.5</b> 2,5 mm için Yan Kapak Push-in Tip	50	0,50 \$
	065 096 000068	<b>MA802</b> Durdurucu Kapak	50	0,73 \$		065 096 000054	<b>MEPCX4</b> 4 mm için Yan Kapak Push-in Tip	50	0,50 \$
	065 096 000070	<b>MGMH6</b> Grup Etiketleri	25	0,63 \$		065 096 000056	<b>MEPCX6</b> 6/10 mm için Yan Kapak Push-in Tip	50	0,50 \$
	065 096 00140	<b>MPPCX4</b> 4 mm Bölüm Plakası	50	0,60 \$		065 096 000118	<b>MEPCP1.5/3</b> 1,5 mm için Çoklu Yan Kapak Push-in Tip	50	0,60 \$
	065 096 00142	<b>TX2.5</b> 2,5 mm Modülü	20	5,00 \$		065 096 000120	<b>MEPCX1.5/4</b> 1,5 mm için Çoklu Yan Kapak Push-in Tip	50	0,73 \$
	065 096 000080	<b>MA741/10</b> 2,5 mm için Üst Köprü Vidalı Tip 10'lu - 24A	10	5,00 \$		065 096 000122	<b>MEPCX2.5/3</b> 2,5 mm için Çoklu Yan Kapak Push-in Tip	50	0,67 \$
	065 096 000082	<b>MA742/10</b> 4 mm için Üst Köprü Vidalı Tip 10'lu - 32A	10	5,00 \$		065 096 000072	<b>MEP2.5/4</b> 2,5 mm için Çoklu Yan Kapak Push-in Tip	50	0,63 \$
	065 096 000084	<b>MA743/10</b> 6 mm için Üst Köprü Vidalı Tip 10'lu - 41A	10	5,00 \$		065 096 000060	<b>MEPCXDL2.5</b> 2,5 mm için Çift Katlı Yan Kapak Push-in Tip	10	0,53 \$
	065 096 000086	<b>MA744/10</b> 10 mm için Üst Köprü Vidalı Tip 10'lu - 57A	10	6,67 \$		065 096 000076	<b>MEPCDL4</b> 4 mm için Yan Kapak Vidalı Tip	10	0,83 \$
	065 096 000088	<b>MA747/10</b> Üst Köprü Çift Katlı Vidalı Tip 10'lu Büyük - 32A	10	5,00 \$		065 096 000100	<b>MC3.5</b> 1,5 mm için Etiket	10	0,05 \$
	065 096 000090	<b>MA722/10</b> 10 mm için Üst Köprü Çift Katlı Vidalı Tip 10'lu - 32A	10	5,00 \$		065 096 000102	<b>MC5</b> 2,5 mm için Etiket	10	0,05 \$
	065 096 000092	<b>MJX1.5/10</b> 1,5 mm için Üst Köprü Push-in Tip 10'lu	10	5,80 \$		065 096 000104	<b>MC6</b> 4 mm için Etiket	10	0,05 \$
	065 096 000020	<b>MJX2.5/10</b> 2,5 mm için Üst Köprü Push-in Tip 10'lu - 24A	10	3,33 \$		065 096 000106	<b>MC8</b> 6 mm için Etiket	10	0,05 \$
	065 096 000022	<b>MJX4/10</b> 4 mm için Üst Köprü Push-in Tip 10'lu - 32A	10	3,83 \$		065 096 000108	<b>MC10</b> 10 mm için Etiket	10	0,05 \$
	065 096 000044	<b>MJX6/10</b> 6/10 mm için Köprü Push-in Tip 10'lu - 41A	10	5,00 \$		065 096 000110	<b>MC12</b> 16 mm için Etiket	10	0,05 \$
						065 096 000112	<b>MC16</b> 35-120 mm için Etiket	10	0,05 \$
						065 096 00124	Promex Etiket Makinesi		
						065 096 00126	Etiket Makinesi Marker		
						065 096 00128	Promex Şerit Etiketleri 15 Mt.		
						065 096 00130	Promex Buton Etiketleri		
						065 096 00132	Promex Genel Etiket		
						065 096 00134	Promex Ribon - Siyah		
						065 096 00136	Promex Ribon - Kırmızı		
						065 096 00138	Promex Ribon - Mavi		

FİYAT  
SORUNUZ



# ALEV YAYMAYAN SIRA KLEMENSLER

Güvenli Bağlantılar İçin İdeal Seçim!

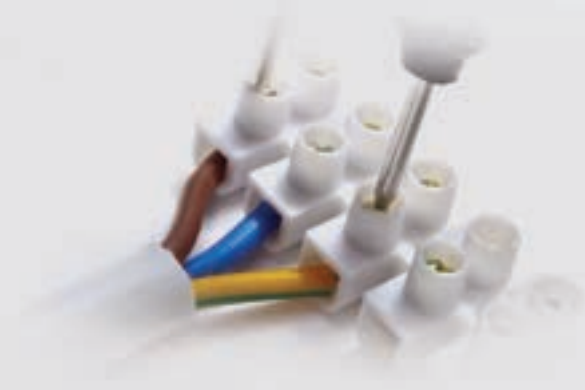
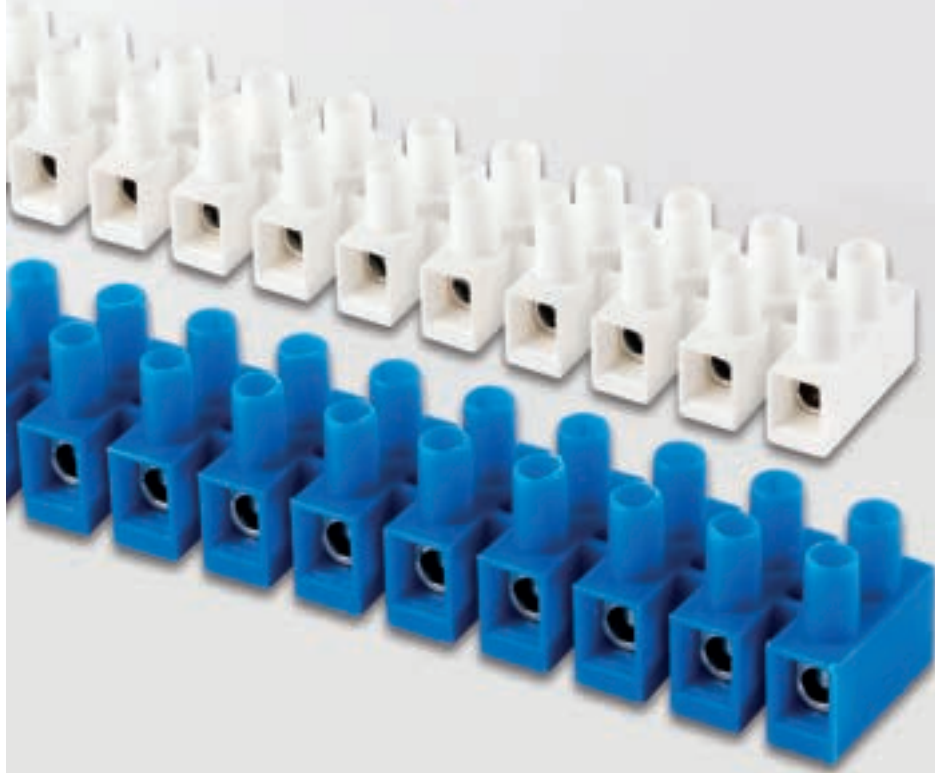

**850°C**  
**ALEV YAYMAZLIK**

## 750° ALEV YAYMAYAN SIRA KLEMENSLER



Ürün Kodu	Ürün Adı	Kutu Adet	Koli Adet	Fiyat
015 094 150001	NO.1 750° ALEV YAYMAYAN SIRA KLEMENS (2.5-4 mm <sup>2</sup> )	50	600	50,83
015 094 150002	NO.2 750° ALEV YAYMAYAN SIRA KLEMENS (4-6 mm <sup>2</sup> )	50	400	66,30
015 094 150003	NO.3 750° ALEV YAYMAYAN SIRA KLEMENS (6-10 mm <sup>2</sup> )	50	300	88,85
015 094 150004	NO.4 750° ALEV YAYMAYAN SIRA KLEMENS (10-16 mm <sup>2</sup> )	50	400	91,13
015 094 150005	NO.5 750° ALEV YAYMAYAN SIRA KLEMENS (16-25 mm <sup>2</sup> )	50	300	107,41

## 850° ALEV YAYMAYAN SIRA KLEMENSLER



Ürün Kodu	Ürün Adı	Kutu Adet	Koli Adet	Fiyat
015 094 170001	NO.1 850° ALEV YAYMAYAN SIRA KLEMENS (2.5-4 mm <sup>2</sup> )	50	600	54,11
015 094 170002	NO.2 850° ALEV YAYMAYAN SIRA KLEMENS (4-6 mm <sup>2</sup> )	50	400	70,51
015 094 170003	NO.3 850° ALEV YAYMAYAN SIRA KLEMENS (6-10 mm <sup>2</sup> )	50	300	96,30
015 094 170004	NO.4 850° ALEV YAYMAYAN SIRA KLEMENS (10-16 mm <sup>2</sup> )	50	400	96,75
015 094 170005	NO.5 850° ALEV YAYMAYAN SIRA KLEMENS (16-25 mm <sup>2</sup> )	50	300	118,52

GEÇMELİ ve  
TIRNAK TİP

□ □ □ □

□ □ □ □ □ □ □ □

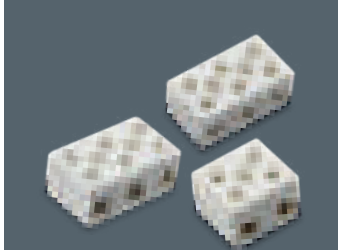
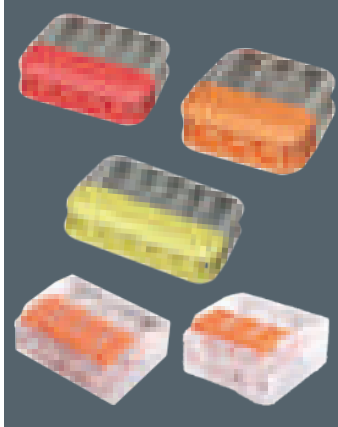

Ürün Kodu	Ürün Adı	Kutu Adet	Koli Adet	Fiyat
<b>SWISS GEÇMELİ BUAT KLEMENS</b>				<b>CE</b>
999 094 225000	2'Lİ GEÇMELİ BUAT KLEMENS (0,5-2,5 mm <sup>2</sup> )	100	5000	0,1382 \$
999 094 325000	3'LÜ GEÇMELİ BUAT KLEMENS (0,5-2,5 mm <sup>2</sup> )	100	5000	0,1437 \$
999 094 425000	4'LÜ GEÇMELİ BUAT KLEMENS (0,5-2,5 mm <sup>2</sup> )	100	5000	0,1658 \$
999 094 525000	5'Lİ GEÇMELİ BUAT KLEMENS (0,5-2,5 mm <sup>2</sup> )	100	5000	0,1934 \$
999 094 625000	6-Lİ GEÇMELİ BUAT KLEMENS (0,5-2,5 mm <sup>2</sup> )	50	2500	0,2570 \$
999 094 825000	8-Lİ GEÇMELİ BUAT KLEMENS (0,5-2,5 mm <sup>2</sup> )	50	2500	0,2901 \$
<b>SWISS TIRNAKLI BUAT KLEMENS</b>				<b>CE</b>
999 094 241000	2'Lİ TIRNAKLI BUAT KLEMENS (0,5-2,5 mm <sup>2</sup> )	100	5000	0,2625 \$
999 094 341000	3'LÜ TIRNAKLI BUAT KLEMENS (0,5-2,5 mm <sup>2</sup> )	100	5000	0,3454 \$
999 094 441000	4-LÜ TIRNAKLI BUAT KLEMENS (0,5-2,5 mm <sup>2</sup> )	50	2500	0,4200 \$
999 094 541000	5'Lİ TIRNAKLI BUAT KLEMENS (0,5-2,5 mm <sup>2</sup> )	50	2500	0,4974 \$
<b>ŞEFFAF ISIYA DAYANIKLI BUAT KLEMENSLER</b>				<b>CE</b>
888 094 000105	NO.2 ŞEFFAF BUAT KLEMENS (1 ADET FİYAT)	560		7,87
888 094 000205	NO.3 ŞEFFAF BUAT KLEMENS (1 ADET FİYAT)	360		11,07
888 094 000405	NO.4 ŞEFFAF BUAT KLEMENS (1 ADET FİYAT)	200		18,10
888 094 000605	NO.5 ŞEFFAF BUAT KLEMENS (1 ADET FİYAT)	120		24,45
<b>PORSELEN KLEMENSLER</b>				<b>CE</b>
015 094 180002	NO. 1-2'Lİ PORSELEN KLEMENS (2,5-4 mm <sup>2</sup> )	396	1584	17,97
015 094 180003	NO. 1-3'LÜ PORSELEN KLEMENS (2,5-4 mm <sup>2</sup> )	264	1056	21,82
015 094 180004	NO. 2-2'Lİ PORSELEN KLEMENS (4-6 mm <sup>2</sup> )	250	1000	21,82
015 094 180005	NO. 2-3'LÜ PORSELEN KLEMENS (4-6 mm <sup>2</sup> )	150	600	31,23
015 094 180006	NO. 3-2'Lİ PORSELEN KLEMENS (6-10 mm <sup>2</sup> )	128	512	31,23
015 094 180007	NO. 3-3'LÜ PORSELEN KLEMENS (6-10 mm <sup>2</sup> )	84	336	48,15
<b>GEÇMELİ SOKET KLEMENSLER</b>				<b>CE</b>
999 999 991212	12'Lİ GEÇMELİ SOKET KLEMENS	25	500	240,74
<b>U KLEMENSLER</b>				<b>CE</b>
014 094 030006	6'LİK U KLEMENS	300		37,57
014 094 030010	10'LÜK U KLEMENS	250		48,60
014 094 030016	16'LİK U KLEMENS	100		67,62
014 094 030025	25'LİK U KLEMENS	100		81,71
014 094 030035	35'LİK U KLEMENS	75		89,22
014 094 030050	50'LİK U KLEMENS	50		138,06
014 094 030070	70'LİK U KLEMENS	40		181,73
014 094 030095	95'LİK U KLEMENS	25		225,40
014 094 030120	120'LİK U KLEMENS	20		297,53
014 094 030150	150'LİK U KLEMENS	15		416,14
<b>BUAT KLEMENS</b>				<b>CE</b>
015 094 160001	NO. 2 ZEYTİN (BUAT) KLEMENS	1000	12000	3,75

### PANO TOPRAKLAMA KLEMENLERİ (6x8 mm) 63A

Ürün Kodu	Ürün Adı	L	B	H	Kutu Adet	Fiyat (₺)
014 102 006304	4 DELİK PANO TOPRAKLAMA KLEMENS	6	8	33	100	39,36
014 102 006305	5 DELİK PANO TOPRAKLAMA KLEMENS	6	8	38	100	44,28
014 102 006306	6 DELİK PANO TOPRAKLAMA KLEMENS	6	8	45	100	52,88
014 102 006307	7 DELİK PANO TOPRAKLAMA KLEMENS	6	8	50	100	57,80
014 102 006309	9 DELİK PANO TOPRAKLAMA KLEMENS	6	8	62	100	66,41
014 102 006310	10 DELİK PANO TOPRAKLAMA KLEMENS	6	8	68	100	81,17
014 102 006312	12 DELİK PANO TOPRAKLAMA KLEMENS	6	8	80	100	98,39

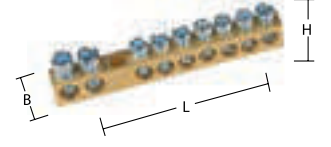

### PANO TOPRAKLAMA KLEMENLERİ AYAKLI (6,5X9 mm) 80A

Ürün Kodu	Ürün Adı	L	B	H	Kutu Adet	Fiyat (₺)
014 102 008006	6 DELİK AYAKLI DAĞITIM ÜNİTESİ	85	70	22	200	93,47
014 102 008010	10 DELİK AYAKLI DAĞITIM ÜNİTESİ	108	95	22	150	122,99
014 102 008012	12 DELİK AYAKLI DAĞITIM ÜNİTESİ	120	106	22	150	132,83
014 102 008015	15 DELİK AYAKLI DAĞITIM ÜNİTESİ	138	124	22	125	158,65
014 102 008020	20 DELİK AYAKLI DAĞITIM ÜNİTESİ	165	152	22	100	209,08

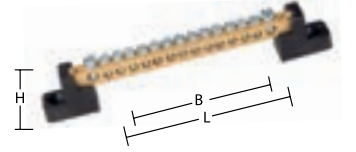

### 1 KUTUP DAĞITIM ÜNİTESİ 125A

CE

Ürün Kodu	Ürün Adı	Cinsi	L	B	H	Koli Adet	Fiyat (₺)
014 102 112507	125 A. 1 KUTUP DAĞITIM ÜNİTESİ	2+5	76	44	42	70	221,38
014 102 112510	125 A. 1 KUTUP DAĞITIM ÜNİTESİ	2+8	100	44	42	60	258,27
014 102 112512	125 A. 1 KUTUP DAĞITIM ÜNİTESİ	2+10	115	44	42	55	295,17
014 102 112515	125 A. 1 KUTUP DAĞITIM ÜNİTESİ	2+13	135	44	42	45	376,34
014 102 112520	125 A. 1 KUTUP DAĞITIM ÜNİTESİ	2+18	170	44	42	35	467,35
014 102 112522	125 A. 1 KUTUP DAĞITIM ÜNİTESİ	2+20	185	44	42	30	516,54

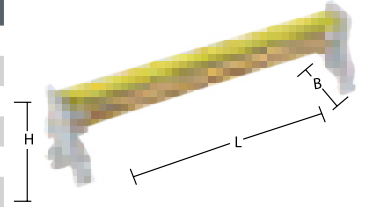

### 2 KUTUP DAĞITIM ÜNİTESİ 125A

CE

Ürün Kodu	Ürün Adı	Cinsi	L	B	H	Koli Adet	Fiyat (₺)
014 102 212507	125 A. 2 KUTUP DAĞITIM ÜNİTESİ	2+5	81	90	50	22	455,05
014 102 212510	125 A. 2 KUTUP DAĞITIM ÜNİTESİ	2+8	103	90	50	15	491,94
014 102 212512	125 A. 2 KUTUP DAĞITIM ÜNİTESİ	2+10	118	90	50	14	541,14
014 102 212515	125 A. 2 KUTUP DAĞITIM ÜNİTESİ	2+13	142	90	50	12	701,02
014 102 212520	125 A. 2 KUTUP DAĞITIM ÜNİTESİ	2+18	178	90	50	6	878,12

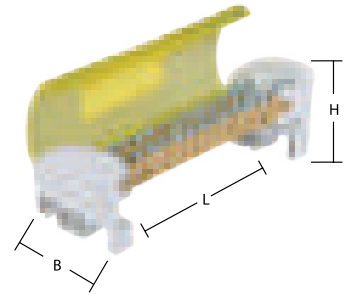

### 4 KUTUP DAĞITIM ÜNİTESİ 125A

CE

Ürün Kodu	Ürün Adı	Cinsi	L	B	H	Koli Adet	Fiyat (₺)
014 102 412507	125 A. 4 KUTUP DAĞITIM ÜNİTESİ	2+5	60	80	75	10	848,60
014 102 412510	125 A. 4 KUTUP DAĞITIM ÜNİTESİ	2+8	83	80	75	8	922,40
014 102 412512	125 A. 4 KUTUP DAĞITIM ÜNİTESİ	2+10	97	80	75	6	1.020,78
014 102 412515	125 A. 4 KUTUP DAĞITIM ÜNİTESİ	2+13	120	80	75	5	1.266,76
014 102 412520	125 A. 4 KUTUP DAĞITIM ÜNİTESİ	2+18	155	80	75	4	1.648,01
014 102 412522	125 A. 4 KUTUP DAĞITIM ÜNİTESİ	2+20	170	80	75	4	1.758,70
014 102 412525	125 A. 4 KUTUP DAĞITIM ÜNİTESİ	2+23	191	80	75	4	2.029,27

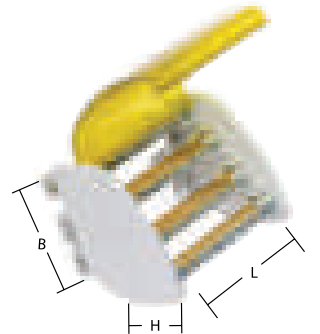



# KABLO BAĞLARI

Kendinden Kilitlemeli Sistem  
Kolay ve Hızlı Montaj  
1.Sınıf Malzeme



Siyah Ürün Kodu	Ürün Adı	Kutu Adet	Koli Adet	Fiyat (₺)
<b>YENİ</b> 062 129 225100	2,5x100 KABLO BAĞI SİYAH	1000 ad.	60.000	0,36
062 129 225140	2,5x140 KABLO BAĞI SİYAH	100 ad.	35.000	0,53
062 129 225200	2,5x200 KABLO BAĞI SİYAH	100 ad.	25.000	0,76
062 129 236150	3,6x150 KABLO BAĞI SİYAH	100 ad.	25.000	0,90
062 129 236205	3,6x205 KABLO BAĞI SİYAH	100 ad.	20.000	1,23
062 129 236250	3,6x250 KABLO BAĞI SİYAH	100 ad.	20.000	1,45
062 129 236300	3,6x300 KABLO BAĞI SİYAH	100 ad.	15.000	1,84
062 129 236370	3,6x370 KABLO BAĞI SİYAH	100 ad.	12.000	2,32
062 129 248200	4,8x200 KABLO BAĞI SİYAH	100 ad.	12.000	1,79
062 129 248250	4,8x250 KABLO BAĞI SİYAH	100 ad.	12.000	2,08
062 129 248300	4,8x300 KABLO BAĞI SİYAH	100 ad.	11.000	2,61
062 129 248350	4,8x350 KABLO BAĞI SİYAH	100 ad.	9.000	3,03
062 129 248400	4,8x400 KABLO BAĞI SİYAH	100 ad.	8.000	3,44
062 129 248450	4,8x450 KABLO BAĞI SİYAH	100 ad.	6.000	4,09
062 129 208250	8x250 KABLO BAĞI SİYAH	100 ad.	6.000	4,16
062 129 208300	8x300 KABLO BAĞI SİYAH	100 ad.	5.000	5,52
062 129 208380	8x380 KABLO BAĞI SİYAH	100 ad.	5.000	5,94
062 129 208450	8x450 KABLO BAĞI SİYAH	100 ad.	3.500	6,65
062 129 208550	8x550 KABLO BAĞI SİYAH	100 ad.	2.500	8,91
062 129 208750	8x750 KABLO BAĞI SİYAH	100 ad.	2.000	14,24
062 129 209762	9x762 KABLO BAĞI SİYAH	100 ad.	1.500	18,99
062 129 209940	9x940 KABLO BAĞI SİYAH	100 ad.	1.500	21,95

Beyaz Ürün Kodu	Siyah Ürün Kodu	Ürün Adı	Kutu Adet	Koli Adet	Fiyat (₺)
		<b>MUTLUSAN KABLO BAĞLARI (SİYAH-BEYAZ)</b>			
062 129 025100	062 129 125100	2,5x100 KABLO BAĞI	1000 ad.	60.000	0,31
062 129 025140	062 129 125140	2,5x140 KABLO BAĞI	100 ad.	35.000	0,46
062 129 025200	062 129 125200	2,5x200 KABLO BAĞI	100 ad.	25.000	0,66
062 129 036150	062 129 136150	3,6x150 KABLO BAĞI	100 ad.	25.000	0,78
062 129 036205	062 129 136205	3,6x205 KABLO BAĞI	100 ad.	20.000	1,07
062 129 036250	062 129 136250	3,6x250 KABLO BAĞI	100 ad.	20.000	1,26
062 129 036300	062 129 136300	3,6x300 KABLO BAĞI	100 ad.	15.000	1,60
062 129 036370	062 129 136370	3,6x370 KABLO BAĞI	100 ad.	12.000	2,02
062 129 048200	062 129 148200	4,8x200 KABLO BAĞI	100 ad.	12.000	1,55
062 129 048250	062 129 148250	4,8x250 KABLO BAĞI	100 ad.	12.000	1,81
062 129 048300	062 129 148300	4,8x300 KABLO BAĞI	100 ad.	11.000	2,27
062 129 048350	062 129 148350	4,8x350 KABLO BAĞI	100 ad.	9.000	2,63
062 129 048400	062 129 148400	4,8x400 KABLO BAĞI	100 ad.	8.000	2,99
062 129 048450	062 129 148450	4,8x450 KABLO BAĞI	100 ad.	6.000	3,56
062 129 008250	062 129 108250	8x250 KABLO BAĞI	100 ad.	6.000	3,61
062 129 008300	062 129 108300	8x300 KABLO BAĞI	100 ad.	5.000	4,80
062 129 008380	062 129 108380	8x380 KABLO BAĞI	100 ad.	5.000	5,16
062 129 008450	062 129 108450	8x450 KABLO BAĞI	100 ad.	3.500	5,78
062 129 008550	062 129 108550	8x550 KABLO BAĞI	100 ad.	2.500	7,74
062 129 008750	062 129 108750	8x750 KABLO BAĞI	100 ad.	2.000	12,39
062 129 009762	062 129 109762	9x762 KABLO BAĞI	100 ad.	1.500	16,52
062 129 009940	062 129 109940	9x940 KABLO BAĞI	100 ad.	1.500	19,09

Ürün Kodu	Ürün Adı	Kutu Adet	Koli Adet	Fiyat (₺)
<b>KROŞE VE KLİPSLER</b>				
062 129 132020	20x20 YAPIŞKANLI KROŞE	100 ad.	20.000	1,80
062 129 132828	28x28 YAPIŞKANLI KROŞE	100 ad.	9.000	3,02
062 129 131316	13x16 YAPIŞKANLI KLİPS	100 ad.	7.000	1,93
062 129 191325	13x25 YAPIŞKANLI KLİPS	100 ad.	5.000	2,56
062 129 132525	25x25 YAPIŞKANLI KLİPS (BEYAZ)	100 ad.	3.000	4,03
062 129 142525	25x25 YAPIŞKANLI KLİPS (SİYAH)	100 ad.	2.000	4,29
062 129 151017	10x17 VİDALI KROŞE	250 ad.	12.500	1,39
062 129 151530	15x30 VİDALI KROŞE	100 ad.	5.000	2,15
062 129 151723	17x23 VİDALI KROŞE	250 ad.	5.000	2,22
062 129 161004	DÜBELLİ KROŞE 6 DELİK İÇİN	500 ad.	15.000	1,08
062 129 171009	DUVAR KROŞESİ 6 DELİK İÇİN	250 ad.	7.500	1,80
033 129 100008	DUVAR KROŞESİ 8 DELİK İÇİN	250 ad.	9.000	2,09
062 129 171011	KANAL KROŞESİ 6 DELİK İÇİN	250 ad.	7.500	1,78
062 129 500003	KABLO KLİPSİ 6,4 (1/4")	100 ad.	10.000	1,17
062 129 500004	KABLO KLİPSİ 7,9 (5/16")	100 ad.	5.000	1,32
062 129 500005	KABLO KLİPSİ 10,9 (3/8")	100 ad.	5.000	1,45

### KELEPÇELER

062 129 010101	2x105	BONCUK KELEPÇE	1000 ad.	25.000	0,56
062 129 010102	3,5x165	BONCUK KELEPÇE	500 ad.	8.000	1,27
062 129 500000	3,5x235	BONCUK KELEPÇE	100 ad.	5.000	2,02
060 120 005105	4,5 mm	BURMA KELEPÇE	500 ad.	50.000	0,73
060 120 007107	7,0 mm	BURMA KELEPÇE	500 ad.	45.000	0,81
060 120 010110	10,5 mm	BURMA KELEPÇE	500 ad.	35.000	0,99
060 120 014114	14 mm	BURMA KELEPÇE	500 ad.	30.000	1,05
060 120 017117	17 mm	BURMA KELEPÇE	500 ad.	15.000	1,22

### ETİKETLER

062 129 111035	10X35 KABLO BAĞI ETİKETİ	100 ad.	4.000	3,08
062 129 112045	20X45 KABLO BAĞI ETİKETİ	100 ad.	1.500	6,17
062 129 121730	17X30 YAPIŞKANLI PANO ETİKETİ	100 ad.	4.000	4,09
062 129 121750	17X50 YAPIŞKANLI PANO ETİKETİ	50 ad.	2.000	5,44
062 129 122075	17X75 YAPIŞKANLI PANO ETİKETİ	25 ad.	1.500	7,42





## KABLO TOPLAMA SİRİRALİ (GRİ - SİYAH)

Ürün Kodu	Ürün Adı	Amb. Birimi	Koli Adedi	Ad. /Mt. Fiyat
888 020 9XX003	R1034 16 mm KABLO TOP. SPR. (1,5m VAK)	1 ad.	120	6,88 \$
888 020 9XX006	R1035 22 mm KABLO TOP. SPR. (1,5m VAK)	1 ad.	80	9,32 \$
888 020 9XX009	R1036 28 mm KABLO TOP. SPR. (1,5m VAK)	1 ad.	70	12,04 \$
888 020 9XX001	R1033 10 mm KABLO TOP. SPR. (50 mt.RULO)	50 mt.	300	2,87 \$
888 020 9XX004	R1034 16 mm KABLO TOP. SPR. (25 mt.RULO)	25 mt.	200	3,51 \$
888 020 9XX007	R1035 22 mm KABLO TOP. SPR. (20 mt.RULO)	20 mt.	160	4,95 \$
888 020 9XX010	R1036 28 mm KABLO TOP. SPR. (15 mt.RULO)	15 mt.	120	6,29 \$
888 020 9XX011	R1037 34 mm KABLO TOP. SPR. (25 mt.RULO)	25 mt.	50	7,33 \$

XX: Gri: 00 Siyah: 11



## KABLO OMURGA KANALI

Ürün Kodu	Ürün Adı	Amb. Birimi	Koli Adedi	Fiyat (₺)
888 020 200801	KABLO OMURGA KANALI - BEYAZ	1 ad.	30	715,56
888 020 200802	KABLO OMURGA KANALI - GRİ	1 ad.	30	715,56
888 020 200803	KABLO OMURGA KANALI - SİYAH	1 ad.	30	715,56

## HELEZON PANO SİRİRALİ

XX yerine 00 Şeffaf / XX yerine 11 Siyah

Ürün Kodu	Ürün Adı	İç Çap	Dış Çap	Amb. Birimi	Koli Adedi	Fiyat (₺)
001 020 500001 05 XX	NO.1 PANO SİRİRALİ (50cm)	5	6	100 ad.	4.000	5,21
001 020 500002 05 XX	NO.2 PANO SİRİRALİ (50cm)	7	8	100 ad.	3.000	6,95
001 020 500003 05 XX	NO.3 PANO SİRİRALİ (50cm)	10	11	100 ad.	2.000	7,83
001 020 500004 05 XX	NO.4 PANO SİRİRALİ (50cm)	13	14	50 ad.	800	14,94
001 020 500005 05 XX	NO.5 PANO SİRİRALİ (50cm)	16	17	25 ad.	800	15,29



## HELEZON PANO SİRİRALİ (RULO)

XX yerine 00 Şeffaf / XX yerine 11 Siyah

Ürün Kodu	Ürün Adı	İç Çap	Dış Çap	Amb. Birimi	Koli Adedi	Fiyat (₺)
001 020 600001 00 XX	NO.1 PANO SİRİRALİ (100cm)	5	6	100 ad.	4.000	10,58
001 020 600002 00 XX	NO.2 PANO SİRİRALİ (100cm)	7	8	100 ad.	3.000	13,01
001 020 600003 00 XX	NO.3 PANO SİRİRALİ (100cm)	10	11	100 ad.	2.000	15,47
001 020 600004 00 XX	NO.4 PANO SİRİRALİ (100cm)	13	14	50 ad.	800	29,51
001 020 600005 00 XX	NO.5 PANO SİRİRALİ (100cm)	16	17	25 ad.	800	30,21



# R-MEKS SERİSİ



X yerine Gri için 7, Siyah için 1 rakamını yazınız.

IP68



750°C'ye  
kadar ısı  
dayanımlı

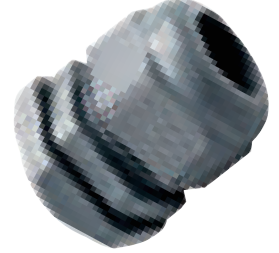

Ürün Kodu	Ürün Adı	Kablo Sıkma Çapı	Kutu Adet	Koli Adet	Fiyat (₺)	
<b>R-MEKS PG PLASTİK KABLO RAKORU</b>						
010 097 1X0007	R-MEKS PG-7	PLASTİK KABLO RAKORU	3-6,5 mm	450	4.500	9,24
010 097 1X0009	R-MEKS PG-9	PLASTİK KABLO RAKORU	4-6 mm	300	3.000	10,81
010 097 1X0011	R-MEKS PG-11	PLASTİK KABLO RAKORU	5-10 mm	200	2.000	13,40
010 097 1X0135	R-MEKS PG-13,5	PLASTİK KABLO RAKORU	6-12 mm	175	1750	14,60
010 097 1X0016	R-MEKS PG-16	PLASTİK KABLO RAKORU	10-14 mm	125	1250	18,11
010 097 1X0021	R-MEKS PG-21	PLASTİK KABLO RAKORU	13-18 mm	75	750	28,64
010 097 1X0029	R-MEKS PG-29	PLASTİK KABLO RAKORU	18-25 mm	40	400	52,21
010 097 1X0036	R-MEKS PG-36	PLASTİK KABLO RAKORU	22-32 mm	20	200	89,08
010 097 1X0042	R-MEKS PG-42	PLASTİK KABLO RAKORU	32-38 mm	15	150	109,59
010 097 1X0048	R-MEKS PG-48	PLASTİK KABLO RAKORU	37-44 mm	12	120	123,45

X yerine Gri için 7, Siyah için 1 rakamını yazınız.

IP68

Ürün Kodu	Ürün Adı	Kablo Sıkma Çapı	Kutu Adet	Koli Adet	Fiyat (₺)
<b>R-MEKS METRİK PLASTİK KABLO RAKORU</b>					
010 097 1X0712	R-MEKS M12X1,5 METRİK PLASTİK KABLO RAKORU (PG 7)	3-6,5 mm	450	4500	9,51
010 097 1X1112	R-MEKS M16X1,5 METRİK PLASTİK KABLO RAKORU (PG 11)	5-10 mm	200	2000	13,55
010 097 1X1320	R-MEKS M20X1,5 METRİK PLASTİK KABLO RAKORU (PG 13,5)	6-12 mm	175	1750	15,59
010 097 1X1620	R-MEKS M20X1,5 METRİK PLASTİK KABLO RAKORU (PG 16)	10-14 mm	125	1250	18,55
010 097 1X2125	R-MEKS M25X1,5 METRİK PLASTİK KABLO RAKORU (PG 21)	13-18 mm	75	750	29,43
010 097 1X2932	R-MEKS M32X1,5 METRİK PLASTİK KABLO RAKORU (PG 29)	18-25 mm	40	400	61,87
010 097 1X3640	R-MEKS M40X1,5 METRİK PLASTİK KABLO RAKORU (PG 36)	22-32 mm	20	200	100,60
010 097 1X4250	R-MEKS M50X1,5 METRİK PLASTİK KABLO RAKOR (PG 42)	32-38 mm	15	150	129,07
010 097 1X4863	R-MEKS M63X1,5 METRİK PLASTİK KABLO RAKORU (PG 48)	37-44 mm	12	120	156,15

# R-MEKS SERİSİ



Bağlantılarınızı Güçlendirin

PG

METRİK

Her ihtiyaca Yönelik Kablo Rakorları



# Promex Rakor

## PLASTİK KABLO RAKORU

IP68



Ürün Kodu	Ürün Adı	Kablo Sıkma Çapı	Delik Çapı	Kutu Adet	Koli Adet	Fiyat (€)
<b>PROMEX SMART PLASTİK KABLO RAKORU</b>						
057 097 411X16	16'LİK SMART KABLO RAKORU	5-10 mm	16 mm	150	1350	0,9417 □
057 097 412X20	20'LİK SMART KABLO RAKORU	6-12 mm	20 mm	120	1080	0,9917 □
057 097 422X25	25'LİK SMART KABLO RAKORU	11-17 mm	25 mm	50	450	1,4310 □
057 097 422X32	32'LİK SMART KABLO RAKORU	15-21 mm	32 mm	40	360	2,4075 □
057 097 422X40	40'LİK SMART KABLO RAKORU	19-28 mm	40 mm	20	180	4,0320 □

IP68



Ürün Kodu	Ürün Adı	Kablo Sıkma Çapı	Delik Çapı	Kutu Adet	Koli Adet	Fiyat (€)
<b>PROMEX PG PLASTİK KABLO RAKORU</b>						
057 097 211X07	PG 7 PLASTİK KABLO RAKORU	3-6.5 mm	13	450	4050	0,3007 □
057 097 212X09	PG 9 PLASTİK KABLO RAKORU	4-8 mm	15,5	300	2700	0,3153 □
057 097 213X11	PG 11 PLASTİK KABLO RAKORU	5-10 mm	19	200	1800	0,3740 □
057 097 214X14	PG 13,5 PLASTİK KABLO RAKORU	6-12 mm	20,5	175	1575	0,4253 □
057 097 215X16	PG 16 PLASTİK KABLO RAKORU	10-14 mm	22,5	125	1125	0,4921 □
057 097 216X21	PG 21 PLASTİK KABLO RAKORU	13-18 mm	28,5	75	675	0,7764 □
057 097 217X29	PG 29 PLASTİK KABLO RAKORU	18-25 mm	37,5	40	360	1,4156 □
057 097 218X36	PG 36 PLASTİK KABLO RAKORU	22-32 mm	47,5	20	180	2,4058 □
057 097 219X42	PG 42 PLASTİK KABLO RAKORU	30-38 mm	54,5	15	135	2,9592 □
057 097 220X48	PG 48 PLASTİK KABLO RAKORU	34-44 mm	60,5	12	108	3,3447 □

IP68



Ürün Kodu	Ürün Adı	Kablo Sıkma Çapı	Delik Çapı (Diş Çekilmiş)	Delik Çapı (Diş Çekme)	Kutu Adedi	Koli Adedi	Fiyat (€)
<b>PROMEX METRİK PLASTİK KABLO RAKORU</b>							
057 097 310X12	M12x1,5 METRİK PLASTİK RAKOR	3-6,5 mm	12 mm	10,5 mm	450	4050	0,3923 □
057 097 311X16	M16x1,5 METRİK PLASTİK RAKOR	5-10 mm	16 mm	14,5 mm	200	1800	0,3800 □
057 097 312X20	M20x1,5 METRİK PLASTİK RAKOR	6-12 mm	20 mm	18,5 mm	175	1575	0,4294 □
057 097 313X20	M20x1,5 METRİK PLASTİK RAKOR	10-14 mm	20 mm	18,5 mm	125	1125	0,5358 □
057 097 314X20	M20x1,5 METRİK PLASTİK RAKOR	10-14 mm	20 mm	18,5 mm	125	1125	0,5386 □
057 097 315X25	M25x1,5 METRİK PLASTİK RAKOR	13-18 mm	25 mm	23,5 mm	75	675	0,7897 □
057 097 316X25	M25x1,5 METRİK PLASTİK RAKOR	13-18 mm	25 mm	23,5 mm	75	675	0,8400 □
057 097 317X32	M32x1,5 METRİK PLASTİK RAKOR	18-25 mm	32 mm	30,5 mm	40	360	1,6680 □
057 097 318X40	M40x1,5 METRİK PLASTİK RAKOR	22-32 mm	40 mm	38,5 mm	20	180	2,6535 □
057 097 319X50	M50x1,5 METRİK PLASTİK RAKOR	30-38 mm	50 mm	48,5 mm	15	135	3,4937 □
057 097 320X63	M63x1,5 METRİK PLASTİK RAKOR	34-44 mm	63 mm	61,5 mm	12	108	3,9947 □

Bu ürün kodlarında **X** ürün rengini belirtmektedir.

Sipariş vereceğiniz zaman ürün kodunda **X** yazan yere aşağıdaki renk kodlarından bir tanesini yazmanız gerekir.

0 = Açık gri

1 = Siyah

3 = Gri

\* Smart rakorların çıkartma somunları harici olarak satılmaktadır.



Promex Rakorlar Hakkında  
Daha Fazla Bilgi İçin

Ürün Kodu	Ürün Adı	Kablo Sıkma Çapı	Diş Boyu	Kutu Adet	Koli Adet	Fiyat (€)
<b>PROMEX PLASTİK SİRAL RAKORLAR(GRİ)</b>						
057 097 601007	PROMEX PG-7 SİRAL UÇLU RAKOR (GRİ)	3,00-6,50	8 mm	100	2500	0,9361 □
057 097 602009	PROMEX PG-9 SİRAL UÇLU RAKOR (GRİ)	4,00-8,00	8 mm	50	1500	1,1301 □
057 097 603011	PROMEX PG-11 SİRAL UÇLU RAKOR (GRİ)	5,00-10,00	8 mm	50	1500	1,2524 □
057 097 604014	PROMEX PG-13,5 SİRAL UÇLU RAKOR (GRİ)	6,00-12,00	10 mm	50	1000	1,4463 □
057 097 605016	PROMEX PG-16 SİRAL UÇLU RAKOR (GRİ)	10,00-14,00	10 mm	50	500	1,4843 □
057 097 606021	PROMEX PG-21 SİRAL UÇLU RAKOR (GRİ)	13,00-18,00	11 mm	25	250	2,1336 □

Ürün Kodu	Ürün Adı	Kutu Adet	Koli Adet	Fiyat (€)
<b>PROMEX HAVALANDIRMA TAPASI PLASTİK</b>				
057 097 701006	PROMEX M6X0,75 HAVALANDIRMA TAPASI PLASTİK (GRİ)	100	10000	3,0149 □
057 097 702008	PROMEX M8X1,0 HAVALANDIRMA TAPASI PLASTİK (GRİ)	100	5000	3,1541 □
057 097 703012	PROMEX M12X1,5 HAVALANDIRMA TAPASI PLASTİK (GRİ)	100	3000	3,3860 □
057 097 704016	PROMEX M16X1,5 HAVALANDIRMA TAPASI PLASTİK (GRİ)	100	1000	4,6383 □
057 097 705020	PROMEX M20X1,5 HAVALANDIRMA TAPASI PLASTİK (GRİ)	100	1000	5,1949 □
057 097 706040	PROMEX M40X1,5 HAVALANDIRMA TAPASI PLASTİK (GRİ)	50	200	16,9299 □

Ürün Kodu	Ürün Adı	Kablo Sıkma Çapı	Diş Boyu	Kutu Adet	Koli Adet	Fiyat (€)
<b>PROMEX METAL RAKORLAR</b>						
057 097 101007	PROMEX PG 7 METAL RAKOR TL6	3,00-6,5	6 mm	50	1000	2,0409 □
057 097 102009	PROMEX PG 9 METAL RAKOR TL6	4,00-8,00	6 mm	50	900	2,5637 □
057 097 103011	PROMEX PG 11 METAL RAKOR TL6	5,00-10,00	6 mm	50	600	3,2342 □
057 097 104014	PROMEX PG 13,5 METAL RAKOR TL6,5	6,00-12,00	6,5 mm	50	500	3,6769 □
057 097 105016	PROMEX PG 16 METAL RAKOR TL6,5	10,00-14,00	6,5 mm	50	400	4,2588 □
057 097 106021	PROMEX PG 21 METAL RAKOR TL7,2	13,00-18,00	7,2 mm	25	200	6,9786 □
057 097 107029	PROMEX PG 29 METAL RAKOR TL8	18,00-25,00	8 mm	10	100	14,3831 □
057 097 108036	PROMEX PG 36 METAL RAKOR TL9	22,00-32,00	9 mm	5	50	22,9808 □
057 097 109042	PROMEX PG 42 METAL RAKOR TL12	30,00-38,00	12 mm	5	40	34,9520 □
057 097 111048	PROMEX PG 48 METAL RAKOR TL14	34,00-44,00	14 mm	5	40	41,7028 □
057 097 101107	PROMEX M12x1,5 METAL RAKOR (PG7) TL6	3,00-6,50	6 mm	50	1000	2,2433 □
057 097 101109	PROMEX M16x1,5 METAL RAKOR (PG9) TL7	4,00-8,00	7 mm	50	900	2,7619 □
057 097 101114	PROMEX M20x1,5 METAL RAKOR (PG13,5) TL8	6,00-12,00	8 mm	50	500	3,6769 □
057 097 101116	PROMEX M25x1,5 METAL RAKOR (PG16) TL8	13,00-18,00	8 mm	25	350	5,6925 □
057 097 101121	PROMEX M32x1,5 METAL RAKOR (PG21) TL9	18,00-25,00	9 mm	10	200	9,3610 □
057 097 101129	PROMEX M40x1,5 METAL RAKOR (PG29) TL9	22,00-32,00	9 mm	10	100	15,9559 □
057 097 101136	PROMEX M50x1,5 METAL RAKOR (PG36) TL9	34,00-44,00	9 mm	5	50	26,4174 □
057 097 101148	PROMEX M63x1,5 METAL RAKOR (PG48) TL14	34,00-44,00	14 mm	5	40	47,2435 □

Ürün Kodu	Ürün Adı	Kablo Sıkma Çapı	Diş Boyu	Kutu Adet	Koli Adet	Fiyat (€)
<b>PROMEX PLASTİK VE METAL HAVALANDIRMA RAKORLARI</b>						
057 097 801012	PROMEX M12X1,5 HAVALANDIRMA RAKOR PLASTİK (GRİ)	4,00-7,00	8 mm	100	2000	3,0149 □
057 097 801016	PROMEX M16X1,5 HAVALANDIRMA RAKOR PLASTİK (GRİ)	4,00-7,00	10 mm	50	2000	3,2468 □
057 097 801020	PROMEX M20X1,5 HAVALANDIRMA RAKOR PLASTİK (GRİ)	6,00-11,00	10 mm	50	1500	3,7107 □
057 097 802009	PROMEX PG 9 HAVALANDIRMA RAKOR PLASTİK (GRİ)	4,00-7,00	8 mm	50	2000	3,0149 □
057 097 802011	PROMEX PG 11 HAVALANDIRMA RAKOR PLASTİK (GRİ)	4,00-7,00	8 mm	50	2000	3,2468 □
057 097 802014	PROMEX PG 13,5 HAVALANDIRMA RAKOR PLASTİK (GRİ)	6,00-11,00	9 mm	50	1500	3,7107 □
057 097 803012	PROMEX M12X1,5 HAVALANDIRMA RAKOR METAL	2,00-6,00	8 mm	50	1000	10,6682 □
057 097 803016	PROMEX M16X1,5 HAVALANDIRMA RAKOR METAL	4,00-7,00	8 mm	50	900	11,5958 □
057 097 803020	PROMEX M20X1,5 HAVALANDIRMA RAKOR METAL	6,00-11,00	8 mm	50	500	14,6571 □
057 097 804007	PROMEX PG 7 HAVALANDIRMA RAKORU METAL	2,00-6,00	8 mm	50	1000	10,6682 □
057 097 804009	PROMEX PG 9 HAVALANDIRMA RAKORU METAL	4,00-7,00	8 mm	50	900	11,5958 □
057 097 804011	PROMEX PG 11 HAVALANDIRMA RAKORU METAL	5,00-9,00	8 mm	50	600	14,5475 □
057 097 804014	PROMEX PG 13,5 HAVALANDIRMA RAKORU METAL	6,00-11,0	9 mm	50	500	16,2342 □

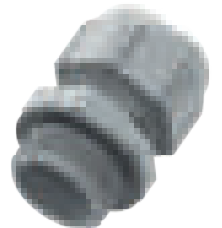
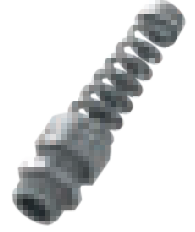

“Her Bağlantıda; KALİTE”

# POLYAMİD SİRAL RAKORLARI



Ürün Kodu	Ürün Adı	Kutu Adet	Koli Adet	Fiyat (€)
-----------	----------	-----------	-----------	-----------

## POLYAMİD SİRAL RAKORU **X yerine Gri için 7, Siyah için 1 rakamını yazınız.**

057 097 1X0007	PSR-7 SİRAL RAKORU (GRİ-SİYAH)	50 ad.		0,5700 □
057 097 1X0009	PSR-9 SİRAL RAKORU (GRİ-SİYAH)	50 ad.		0,5700 □
057 097 1X0011	PSR-11 SİRAL RAKORU (GRİ-SİYAH)	50 ad.		0,6000 □
057 097 1X0135	PSR-13,5 SİRAL RAKORU (GRİ-SİYAH)	50 ad.		0,6900 □
057 097 1X0016	PSR-16 SİRAL RAKORU (GRİ-SİYAH)	50 ad.		0,7400 □
057 097 1X0021	PSR-21 SİRAL RAKORU (GRİ-SİYAH)	25 ad.		1,0300 □
057 097 1X0029	PSR-29 SİRAL RAKORU (GRİ-SİYAH)	20 ad.		1,7100 □
057 097 1X0036	PSR-36 SİRAL RAKORU (GRİ-SİYAH)	10 ad.		2,4000 □
057 097 1X0048	PSR-48 SİRAL RAKORU (GRİ-SİYAH)	1 ad.		3,2900 □



## METRİK POLYAMİD SİRAL RAKORU

057 097 111012	M12X1.5 (PSR-7) POLYAMİD SİRAL REKORU (SİYAH)	50 ad.		0,5700 □
057 097 111016	M16X1.5 (PSR-9) POLYAMİD SİRAL REKORU (SİYAH)	50 ad.		0,5700 □
057 097 111018	M18X1.5 (PSR-11) POLYAMİD SİRAL REKORU (SİYAH)	50 ad.		0,6000 □
057 097 111020	M20X1.5 (PSR-13,5) POLYAMİD SİRAL REKORU (SİYAH)	50 ad.		0,6900 □
057 097 111025	M25X1.5 (PSR-16) POLYAMİD SİRAL REKORU (SİYAH)	50 ad.		0,7400 □
057 097 111125	M25X1.5 (PSR-21) POLYAMİD SİRAL REKORU (SİYAH)	25 ad.		1,0300 □
057 097 111032	M32X1.5 (PSR-29) POLYAMİD SİRAL REKORU (SİYAH)	20 ad.		1,7100 □
057 097 111040	M40X1.5 (PSR-36) POLYAMİD SİRAL REKORU (SİYAH)	10 ad.		2,4000 □
057 097 111050	M50X1.5 (PSR-48) POLYAMİD SİRAL REKORU (SİYAH)	1 ad.		3,2900 □



## POLYAMİD SİRAL DİRSEĞİ **X yerine Gri için 7, Siyah için 0 rakamını yazınız.**

057 097 12X007	PSRD-7 SİRAL RAKORU 90° DİRSEK (GRİ-SİYAH)	1 ad.		1,2000 □
057 097 12X009	PSRD-9 SİRAL RAKORU 90° DİRSEK (GRİ-SİYAH)	1 ad.		1,2800 □
057 097 12X011	PSRD-11 SİRAL RAKORU 90° DİRSEK (GRİ-SİYAH)	1 ad.		1,4100 □
057 097 12X135	PSRD-13,5 SİRAL RAKORU 90° DİRSEK (GRİ-SİYAH)	1 ad.		1,6700 □
057 097 12X016	PSRD-16 SİRAL RAKORU 90° DİRSEK (GRİ-SİYAH)	1 ad.		1,9300 □
057 097 12X021	PSRD-21 SİRAL RAKORU 90° DİRSEK (GRİ-SİYAH)	1 ad.		3,0800 □



## POLYAMİD SİRAL KROŞELERİ **CE**

057 097 160007	PG-7 POLYAMİD SİRAL KROŞESİ (GRİ-SİYAH)	50 ad.		0,7000 □
057 097 160009	PG-9 POLYAMİD SİRAL KROŞESİ (GRİ-SİYAH)	50 ad.		0,8000 □
057 097 160011	PG-11 POLYAMİD SİRAL KROŞESİ (GRİ-SİYAH)	50 ad.		0,9000 □
057 097 160135	PG-13,5 POLYAMİD SİRAL KROŞESİ (GRİ-SİYAH)	50 ad.		1,0000 □
057 097 160016	PG-16 POLYAMİD SİRAL KROŞESİ (GRİ-SİYAH)	50 ad.		1,1000 □
057 097 160021	PG-21 POLYAMİD SİRAL KROŞESİ (GRİ-SİYAH)	25 ad.		1,2500 □
057 097 160029	PG-29 POLYAMİD SİRAL KROŞESİ (GRİ-SİYAH)	25 ad.		1,5200 □
057 097 160036	PG-36 POLYAMİD SİRAL KROŞESİ (GRİ-SİYAH)	25 ad.		2,3300 □
057 097 160048	PG-48 POLYAMİD SİRAL KROŞESİ (GRİ-SİYAH)	10 ad.		3,2400 □



X yerine Gri için 7, Siyah için 1 rakamını yazınız.

Ürün Kodu	Ürün Adı	Kutu Adet	Koli Adet	Fiyat (₺)
-----------	----------	-----------	-----------	-----------

### SUNFLEX POLYAMİD SİRİRAL BORU (UV DAYANIMLI)

Rakor Ölçüsü Ort. İç Çap Ort. Dış Çap

001 020 180007 00 XX	Ø7 POLYAMİD SİRİRAL BORU(UV DAYANIMLI)	PSR7	7	10,1	100 mt.	1000	22,28
001 020 180009 00 XX	Ø8,5 POLYAMİD SİRİRAL BORU(UV DAYANIMLI)		8,4	12,05	100 mt.	1000	24,03
001 020 180010 00 XX	Ø10 POLYAMİD SİRİRAL BORU(UV DAYANIMLI)	PSR9	10,2	13,1	100 mt.	1000	25,73
001 020 180012 00 XX	Ø12 POLYAMİD SİRİRAL BORU(UV DAYANIMLI)	PSR11	12,3	15,9	50 mt.	500	41,69
001 020 180014 00 XX	Ø14 POLYAMİD SİRİRAL BORU(UV DAYANIMLI)	PSR13,5	14,1	18,35	50 mt.	250	46,12
001 020 180017 00 XX	Ø17 POLYAMİD SİRİRAL BORU(UV DAYANIMLI)	PSR16	17	21,45	50 mt.	250	58,75
001 020 180019 00 XX	Ø19 POLYAMİD SİRİRAL BORU(UV DAYANIMLI)		19	24,25	50 mt.	250	68,42
001 020 180023 00 XX	Ø23 POLYAMİD SİRİRAL BORU(UV DAYANIMLI)	PSR21	23,25	28,5	50 mt.	250	77,49
001 020 180026 00 XX	Ø26 POLYAMİD SİRİRAL BORU(UV DAYANIMLI)		26,2	31,3	25 mt.	125	88,89
001 020 180029 00 XX	Ø29 POLYAMİD SİRİRAL BORU(UV DAYANIMLI)	PSR29	29,1	34,3	25 mt.	125	100,76
001 020 180036 00 XX	Ø36 POLYAMİD SİRİRAL BORU(UV DAYANIMLI)	PSR36	36,2	42,2	25 mt.	125	133,53
001 020 180048 00 XX	Ø48 POLYAMİD SİRİRAL BORU(UV DAYANIMLI)	PSR48	48,5	54,5	25 mt.	125	183,94



### PA6 POLYAMİD SİRİRALER (ALEV YAYMAYAN)

001 020 170007 00 XX	MUT/PA6-7 (A. YAYMAYAN)	PSR7	7	10,1	100 mt.	1000	17,26
001 020 170009 00 XX	MUT/PA6-8,5 (A. YAYMAYAN)		8,4	12,05	100 mt.	1000	18,56
001 020 170010 00 XX	MUT/PA6-10 (A. YAYMAYAN)	PSR9	10,2	13,1	100 mt.	1000	19,82
001 020 170012 00 XX	MUT/PA6-12 (A. YAYMAYAN)	PSR11	12,3	15,9	50 mt.	500	32,18
001 020 170014 00 XX	MUT/PA6-14 (A. YAYMAYAN)	PSR13,5	14,1	18,35	50 mt.	250	35,48
001 020 170017 00 XX	MUT/PA6-17 (A. YAYMAYAN)	PSR16	17	21,45	50 mt.	250	44,92
001 020 170019 00 XX	MUT/PA6-19 (A. YAYMAYAN)		19	24,25	50 mt.	250	52,12
001 020 170023 00 XX	MUT/PA6-23 (A. YAYMAYAN)	PSR21	23,25	28,5	50 mt.	250	58,90
001 020 170026 00 XX	MUT/PA6-26 (A. YAYMAYAN)		26,2	31,3	25 mt.	125	68,12
001 020 170029 00 XX	MUT/PA6-29 (A. YAYMAYAN)	PSR29	29,1	34,3	25 mt.	125	77,01
001 020 170036 00 XX	MUT/PA6-36 (A. YAYMAYAN)	PSR36	36,2	42,2	25 mt.	125	101,43
001 020 170048 00 XX	MUT/PA6-48 (A. YAYMAYAN)	PSR48	48,5	54,5	25 mt.	125	140,82

### POLİPROPİLEN SİRİRAL BORU

001 020 160007 00 XX	MUT/PP-7 PP SİRİRAL BORU	PSR7	7	10,1	100 mt.	1000	10,23
001 020 160009 00 XX	MUT/PP-8,5 PP SİRİRAL BORU		8,4	12,05	100 mt.	1000	10,87
001 020 160010 00 XX	MUT/PP-10 PP SİRİRAL BORU	PSR9	10,2	13,1	100 mt.	1000	11,50
001 020 160012 00 XX	MUT/PP-12 PP SİRİRAL BORU	PSR11	12,3	15,9	50 mt.	500	18,32
001 020 160014 00 XX	MUT/PP-14 PP SİRİRAL BORU	PSR13,5	14,1	18,35	50 mt.	250	21,47
001 020 160017 00 XX	MUT/PP-17 PP SİRİRAL BORU	PSR16	17	21,45	50 mt.	250	25,01
001 020 160019 00 XX	MUT/PP-19 PP SİRİRAL BORU		19	24,25	50 mt.	250	27,50
001 020 160023 00 XX	MUT/PP-23 PP SİRİRAL BORU	PSR21	23,25	28,5	50 mt.	250	30,08
001 020 160026 00 XX	MUT/PP-26 PP SİRİRAL BORU		26,2	31,3	25 mt.	125	37,33
001 020 160029 00 XX	MUT/PP-29 PP SİRİRAL BORU	PSR29	29,1	34,3	25 mt.	125	40,90
001 020 160036 00 XX	MUT/PP-36 PP SİRİRAL BORU	PSR36	35,8	42,2	25 mt.	125	55,19
001 020 160048 00 XX	MUT/PP-48 PP SİRİRAL BORU	PSR48	48,5	54,5	25 mt.	125	77,29

### POLYAMİD YARIKLI SİRİRAL BORU (ALEV YAYMAYAN)

001 020 470007 00 XX	Ø7 POLYAMİD YARIKLI SİRİRAL BORU(ALEV YAYMAYAN)				100 mt.	1000	18,47
001 020 470009 00 XX	Ø8,5 POLYAMİD YARIKLI SİRİRAL BORU(ALEV YAYMAYAN)				100 mt.	1000	19,86
001 020 470010 00 XX	Ø10 POLYAMİD YARIKLI SİRİRAL BORU(ALEV YAYMAYAN)				100 mt.	1000	21,21
001 020 470012 00 XX	Ø12 POLYAMİD YARIKLI SİRİRAL BORU(ALEV YAYMAYAN)				100 mt.	500	34,43
001 020 470014 00 XX	Ø14 POLYAMİD YARIKLI SİRİRAL BORU(ALEV YAYMAYAN)				50 mt.	250	37,96
001 020 470017 00 XX	Ø17 POLYAMİD YARIKLI SİRİRAL BORU(ALEV YAYMAYAN)				50 mt.	250	48,06
001 020 470019 00 XX	Ø19 POLYAMİD YARIKLI SİRİRAL BORU(ALEV YAYMAYAN)				50 mt.	250	55,77
001 020 470023 00 XX	Ø23 POLYAMİD YARIKLI SİRİRAL BORU(ALEV YAYMAYAN)				50 mt.	250	63,02
001 020 470026 00 XX	Ø26 POLYAMİD YARIKLI SİRİRAL BORU(ALEV YAYMAYAN)				25 mt.	125	72,89
001 020 470029 00 XX	Ø29 POLYAMİD YARIKLI SİRİRAL BORU(ALEV YAYMAYAN)				25 mt.	125	82,40
001 020 470036 00 XX	Ø36 POLYAMİD YARIKLI SİRİRAL BORU(ALEV YAYMAYAN)				25 mt.	125	108,53
001 020 470048 00 XX	Ø48 POLYAMİD YARIKLI SİRİRAL BORU(ALEV YAYMAYAN)				25 mt.	125	150,68



# KABLO YÜKSÜKLERİ



## HIZ

Yüksek İletkenlik ve  
Kolay Entegrasyon



## PERFORMANS

Kaliteli Malzeme,  
Elektriksel ve Çevresel  
Dayanıklılık



## BAĞLANTI

Sağlam ve Güvenilir  
Bağlantılar için Doğru  
Ürünler

**İZOLELİ - İZOLESİZ  
FRANSIZ ve ALMAN  
NORM ÇEŞİTLERİ İLE**



## İZOLELİ KABLO YÜKSÜKLERİ - TEK GİRİŞ FRANSIZ - ALMAN NORMLARI

Standart : DIN 46228  
Malzeme : Bakır  
İzolasyon : Nylon  
Voltaj : <600V  
Çalışma Sıcaklığı : Max. 105°

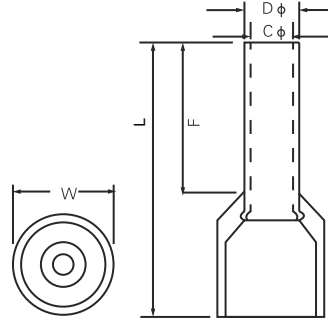

X= 0 Fransız  
X= 2 Alman

X= F Fransız  
X= A Alman

Ürün Kodu	Model Kodu	Ebatlar					Kablo Kesiti	Renk		Kutu Adet	Fiyat (Adet/₺)
		F	L	W	DØ	CØ		Fransız	Alman		
014 100 X10258	ITYX-0258	8.0	12.5	2.5	1.0	0.7	0.25	Menekşe	Mavi	1.000	0,88
014 100 X10348	ITYX-0348	8.0	12.5	2.5	1.1	0.8	0.34	Pembe	Turkuaz	1.000	0,88
014 100 X10508	ITYX-0508	8.0	14.0	2.6	1.3	1.0	0.50	Beyaz	Turuncu	1.000	0,40
014 100 X17508	ITYX-7508	8.0	14.6	2.8	1.6	1.3	0.75	Mavi	Beyaz	1.000	0,40
014 100 X11008	ITYX-1008	8.0	14.6	3.0	1.8	1.5	1.0	Kırmızı	Sarı	1.000	0,40
014 100 X11508	ITYX-1508	8.0	16.4	3.5	2.1	1.8	1.5	Siyah	Kırmızı	1.000	0,44
014 100 X12508	ITYX-2508	8.0	15.2	4.0	2.6	2.3	2.5	Gri	Mavi	500	0,56
014 100 X14009	ITYX-4009	9.0	16.5	4.4	3.2	2.8	4.0	Turuncu	Gri	500	0,93
014 100 X16012	ITYX-6012	12.0	20.0	6.3	3.9	3.5	6.0	Yeşil	Siyah	250	1,28
014 100 X11012	ITYX-1012	12.0	21.5	7.6	4.9	4.5	10.0	Kahverengi	Bej	100	1,60
014 100 X11612	ITYX-1612	12.0	22.2	8.8	6.2	5.8	16.0	Bej	Yeşil	100	2,22
014 100 X12516	ITYX-2516	16.0	29.0	11.2	7.9	7.5	25.0	Siyah	Kahverengi	50	3,73
014 100 X13516	ITYX-3516	16.0	30.0	12.7	8.7	8.3	35.0	Kırmızı	Bej	25	4,67
014 100 X15020	ITYX-5020	20.0	36.0	15.3	10.9	10.3	50.0	Mavi	Yeşil	25	8,75
014 100 017020	ITYF-7020	20.0	37.0	16.0	14.3	13.5	70.0	Sarı	-	25	16,33



## İZOLELİ KABLO YÜKSÜKLERİ - ÇİFT GİRİŞ FRANSIZ - ALMAN NORMLARI

Standart : DIN 46228  
Malzeme : Bakır  
İzolasyon : Nylon  
Voltaj : <600V  
Çalışma Sıcaklığı : Max. 105°

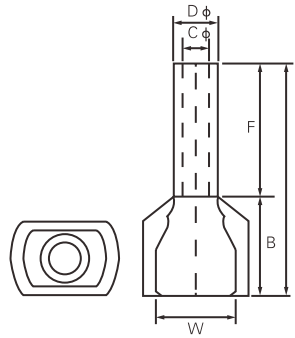

X= 0 Fransız  
X= 2 Alman

X= F Fransız  
X= A Alman

Ürün Kodu	Model Kodu	Ebatlar						Kablo Kesiti	Renk		Kutu Adet	Fiyat (Adet/₺)
		F	L	W	B	DØ	CØ		Fransız	Alman		
014 100 X20508	ICYX-0508	8.0	14.5	5.0	6.5	1.8	1.5	2x0.5	Beyaz	Turuncu	1.000	0,70
014 100 X27508	ICYX-7508	8.0	14.7	5.5	6.7	2.1	1.8	2x0.75	Mavi	Beyaz	500	0,75
014 100 X21008	ICYX-1008	8.0	15.1	5.5	7.1	2.3	2.0	2x1.0	Kırmızı	Sarı	500	0,79
014 100 X21508	ICYX-1508	8.0	15.5	6.4	7.2	2.6	2.3	2x1.5	Siyah	Kırmızı	500	0,96
014 100 X22510	ICYX-2510	10.0	18.5	8.0	8.5	3.3	2.9	2x2.5	Gri	Mavi	250	1,55
014 100 X24012	ICYX-4012	12.0	23.1	8.8	11.1	4.2	3.8	2x4.0	Turuncu	Gri	200	1,81
014 100 X26014	ICYX-6014	14.0	26.1	9.5	12.1	5.3	4.9	2x6.0	Yeşil	Siyah	100	2,59
014 100 X21014	ICYX-1014	14.0	26.6	12.6	12.0	6.9	6.5	2x10.0	Kahverengi	Bej	50	4,07
014 100 X21614	ICYX-1614	14.0	31.3	19.0	17.3	8.7	8.3	2x16.0	Bej	Yeşil	50	5,19

## İZOLESİZ KABLO YÜKSÜKLERİ - TEK GİRİŞ



Standart : DIN 46228  
Malzeme : Bakır  
Voltaj : <600V  
Çalışma Sıcaklığı : Max. 105°

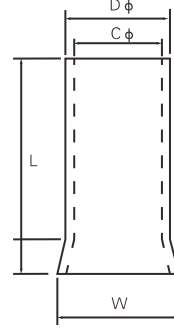

Ürün Kodu	Model Kodu	Ebatlar				Kablo Kesiti	Kutu Adet	Fiyat (Adet/₺)
		L	W	DØ	CØ			
014 100 120510	KTY-0508	10.0	1.7	1.3	1.0	0.50	2.000	0,40
014 100 127510	KTY-7508	10.0	1.9	1.6	1.3	0.75	1.000	0,40
014 100 121010	KTY-1008	10.0	2.2	1.8	1.5	1.0	1.000	0,40
014 100 121510	KTY-1508	10.0	2.5	2.1	1.8	1.5	1.000	0,44
014 100 122512	KTY-2508	12.0	3.3	2.6	2.3	2.5	1.000	0,62
014 100 124012	KTY-4009	12.0	3.9	3.2	2.8	4.0	1.000	0,93
014 100 126012	KTY-6012	12.0	4.8	3.9	3.5	6.0	500	1,11
014 100 121015	KTY-1012	15.0	5.8	4.9	4.5	10.0	250	1,87
014 100 121615	KTY-1612	15.0	7.2	6.2	5.8	16.0	250	2,33
014 100 122516	KTY-2516	16.0	9.1	7.9	7.5	25.0	100	3,58
014 100 123516	KTY-3516	16.0	10.2	8.7	8.3	35.0	100	3,96
014 100 125020	KTY-5020	20.0	12.4	10.9	10.3	50.0	50	8,09



## İZOLELİ YUVARLAK TİP PAPUÇ

Standart : DIN 46228  
Malzeme : Bakır  
İzolasyon : PVC  
Voltaj : <600V  
Çalışma Sıcaklığı : Max. 105°

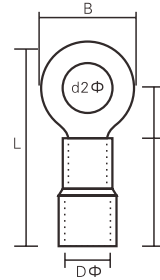

Ürün Kodu	Model Kodu	Civata Çapı (d2) mm	Ebatlar					Renk	Kablo Kesiti	Kutu Adet	Fiyat (Adet/₺)
			B	F	L	E	DØ				
014 100 030153	IYP-1,5-3	3.2	5.7	4.95	17.8	10.0	4.3	Kırmızı	0.5 ~1.5 mm <sup>2</sup> 19A	200	1,41
014 100 030154	IYP-1,5-4	4.3	8.0	7.0	21.0	10.0	4.3			200	1,90
014 100 030155	IYP-1,5-5	5.3	9.5	8.5	22.2	10.0	4.3			200	1,93
014 100 030156	IYP-1,5-6	6.5	11.6	11.1	27.0	10.0	4.3			200	3,03
014 100 030158	IYP-1,5-8	8.5	11.6	11.1	27.0	10.0	4.3			200	3,03
014 100 030253	IYP-2,5-3	3.2	6.6	4.8	17.8	10.0	4.9	Mavi	1.5 ~2.5 mm <sup>2</sup> 27A	200	2,33
014 100 030254	IYP-2,5-4	4.3	8.5	7.4	21.7	10.0	4.9			200	2,33
014 100 030255	IYP-2,5-5	5.3	9.5	7.4	22.5	10.0	4.9			200	2,39
014 100 030256	IYP-2,5-6	6.5	12.0	11.0	27.0	10.0	4.9			200	3,38
014 100 030258	IYP-2,5-8	8.5	12.0	11.0	27.0	10.0	4.9			200	3,38
014 100 032510	IYP-2,5-10	10.5	13.6	13.9	30.7	10.0	4.9	200	3,50		
014 100 036004	IYP-6-4	4.3	9.5	8.3	26.0	13.0	6.7	Sarı	4 ~6 mm <sup>2</sup> 48A	100	4,96
014 100 036005	IYP-6-5	5.3	9.5	8.3	26.0	13.0	6.7			100	4,96
014 100 036006	IYP-6-6	6.5	12.0	10.5	29.5	13.0	6.7			100	5,60
014 100 036008	IYP-6-8	8.5	15.0	13.7	35.0	13.0	6.7			100	7,23
014 100 036010	IYP-6-10	10.5	15.0	13.7	35.0	13.0	6.7			100	7,35
014 100 036012	IYP-6-12	13.0	19.2	16.0	39.4	13.0	6.7			100	7,47

## ÇATAL TİP İZOLELİ KABLO UÇLARI



Standart : DIN 46228  
Malzeme : Bakır  
İzolasyon : PVC  
Voltaj : <600V  
Çalışma Sıcaklığı : Max. 105°

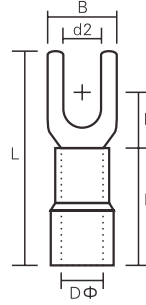

Ürün Kodu	Model Kodu	Civata Çapı (d2) mm	Ebatlar					Renk	Kablo Kesiti	Kutu Adet	Fiyat (Adet/₺)
			B	F	L	H	DØ				
014 100 040153	ICP-1,5-3	3.2	5.7	6.5	21.2	10.0	4.3	Kırmızı	0.5 ~1.5 mm <sup>2</sup> 19A	200	1,75
014 100 040154	ICP-1,5-4	4.3	8.1	6.5	21.2	10.0	4.3			200	1,79
014 100 040155	ICP-1,5-5	5.3	9.5	6.5	21.2	10.0	4.3			200	1,87
014 100 040156	ICP-1,5-6	6.5	12.0	11.0	27.2	10.0	4.3			200	2,41
014 100 040253	ICP-2,5-3	3.2	5.7	6.5	21.2	10.0	4.9	Mavi	1.5 ~2.5 mm <sup>2</sup> 27A	200	1,93
014 100 040254	ICP-2,5-4	4.3	8.1	6.5	21.2	10.0	4.9			200	2,22
014 100 040255	ICP-2,5-5	5.3	9.5	6.5	21.2	10.0	4.9			200	2,41
014 100 040256	ICP-2,5-6	6.5	12.0	11.0	27.2	10.0	4.9			200	3,33
014 100 046004	ICP-6-4	4.3	9.0	7.5	26.5	13.0	6.7	Sarı	4 ~6 mm <sup>2</sup> 48A	100	4,44
014 100 046005	ICP-6-5	5.3	9.0	7.5	26.5	13.0	6.7			100	4,63
014 100 046006	ICP-6-6	6.5	12.0	12.0	32.5	13.0	6.7			100	6,30
014 100 046008	ICP-6-8	8.5	14.0	11.5	31.5	13.0	6.7			100	7,04



## TAM İZOLELİ FASTON DİŞİ TERMİNAL

Malzeme : Pirinç  
İzolasyon : PVC  
Voltaj : <600V  
Çalışma Sıcaklığı : Max. 75°

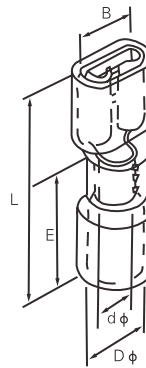

Ürün Kodu	Model Kodu	Soket Ölçüsü	Kalınlık (mm)	Ebatlar					Renk	Kablo Kesiti	Kutu Adet	Fiyat (Adet/₺)
				B	DØ	dØ	L	E				
014 100 090508	TDT-0,5-1/2.8	0.5x2.8	0.30	3.3	3.8	1.7	20.0	10.0	Kırmızı	0.5 ~1.5 mm <sup>2</sup> 10A	200	1,93
014 100 090509	TDT-0,5-1/4.8	0.8x4.75	0.35	5.0	3.8	1.7	20.5	10.0			200	2,28
014 100 090510	TDT-0,5-1/6.4	0.8x6.35	0.40	6.6	3.8	1.7	22.4	10.0			200	2,68
014 100 091523	TDT-1,5-2,5/2.8	0.8x2.8	0.30	3.3	4.3	2.3	20.0	10.0	Mavi	1.5 ~2.5 mm <sup>2</sup> 15A	200	2,28
014 100 091524	TDT-1,5-2,5/4.8	0.8x4.75	0.35	5.0	4.3	2.3	20.5	10.0			200	2,33
014 100 091525	TDT-1,5-2,5/6.4	0.8x6.35	0.40	6.6	4.3	2.3	22.7	10.0			200	2,80
014 100 094060	TDT-4-6	0.8x6.35	0.40	6.6	5.7	3.4	23.0	12.5	Sarı	4 ~6 mm <sup>2</sup> 24A	100	3,27

## TAM İZOLELİ DIŐI TERMİNAL

Malzeme : Pirinç  
İzolasyon : PVC  
Voltaj : <600V  
Çalışma Sıcaklığı : Max.75°

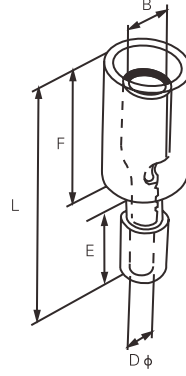

Ürün Kodu	Model Kodu	Kalınlık mm	Ebatlar					Renk	Kablo Kesiti	Kutu Adet	Fiyat (Adet/₺)
			B	F	DØ	E	L				
014 100 100510	YDT-0,5-1	0.40	4.0	7.0	1.7	10.5	23.3	Kırmızı	0.5 ~1.5 mm <sup>2</sup> 10A	200	2,59
014 100 101525	YDT-1,5-2,5	0.40	5.0	7.0	2.3	10.5	25.1	Mavi	1.5 ~2.5 mm <sup>2</sup> 15A	100	3,70
014 100 104060	YDT-4-6	0.40	5.0	7.0	3.4	12.5	25.1	Sarı	4 ~6 mm <sup>2</sup> 24A	100	4,07

## İZOLELİ EK MUF - UZUN TİP

Standart : DIN 46237  
Malzeme : Bakır / Copper  
İzolasyon : PVC  
Voltaj : <600V  
Çalışma Sıcaklığı : Max. 75°

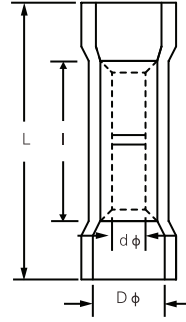

Ürün Kodu	Model Kodu	Maximum Akım	Ebatlar				Renk	Kablo Kesiti	Kutu Adet	Fiyat (Adet/₺)
			I	dØ	DØ	L				
014 100 070015	IEM-1,5	19A	15.0	1.7	4.3	25.0	Kırmızı	0.5 ~1.5 mm <sup>2</sup>	200	2,68
014 100 070025	IEM-2,5	27A	15.0	2.3	4.9	25.0	Mavi	1.5 ~2.5 mm <sup>2</sup>	200	2,68
014 100 070040	IEM-4	48A	15.0	3.4	6.7	25.0	Sarı	4 ~6 mm <sup>2</sup>	100	4,55

## İZOLELİ İĞNE TİP TERMİNAL

Malzeme : Bakır  
İzolasyon : PVC  
Voltaj : <600V  
Çalışma Sıcaklığı : Max. 75°

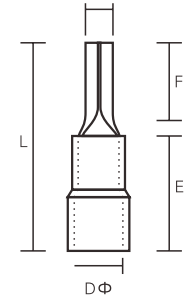

Ürün Kodu	Model Kodu	Kalınlık mm	Ebatlar					Renk	Kablo Kesiti	Kutu Adet	Fiyat (Adet/₺)
			B	F	L	E	DØ				
014 100 050015	IIT-1,5	0.7	1.9	10.0	20.0	10.0	4.3	Kırmızı	0.5 ~1.5 mm <sup>2</sup> 19A	200	1,85
014 100 050025	IIT-2,5	0.8	1.9	12.0	22.0	10.0	4.9	Mavi	1.5 ~2.5 mm <sup>2</sup> 27A	200	2,22
014 100 050040	IIT-4	1.0	2.8	13.0	26.8	13.0	6.7	Sarı	4 ~6 mm <sup>2</sup> 48A	100	5,19

## İZOLELİ FASTON ERKEK TERMİNAL

Malzeme : Pirinç  
İzolasyon : PVC  
Voltaj : <600V  
Çalışma Sıcaklığı : Max. 75°

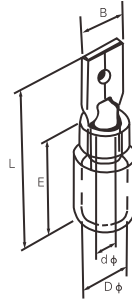

Ürün Kodu	Model Kodu	Soket Ölçüsü	Kalınlık (mm)	Ebatlar					Renk	Kablo Kesiti	Kutu Adet	Fiyat (Adet/₺)
				B	DØ	dØ	L	E				
014 100 060013	IFE-1,5/2.8	0.8x2.8	0.8	2.8	1.7	3.8	17.7	10.0	Kırmızı	0.5 ~1.5 mm <sup>2</sup> 10A	200	1,28
014 100 060014	IFE-1,5/4.8	0.4x4.75	0.4x2	4.8	1.7	3.8	20.0	10.0			200	1,46
014 100 060015	IFE-1,5/6.4	0.8x6.35	0.4x2	6.4	1.7	3.8	21.0	10.0			200	1,87
014 100 060023	IFE-2,5/2.8	0.8x2.8	0.8	2.8	2.3	4.3	17.7	10.0	Mavi	1.5 ~2.5 mm <sup>2</sup> 15A	200	1,28
014 100 060024	IFE-2,5/4.8	0.4x4.75	0.4x2	4.8	2.3	4.3	20.0	10.0			200	1,63
014 100 060025	IFE-2,5/6.4	0.8x6.35	0.4x2	6.4	2.3	4.3	21.0	10.0			200	1,93
014 100 060040	IFE-4	0.8x6.35	0.4x2	6.4	3.4	5.7	23.0	12.5	Sarı	4 ~6 mm <sup>2</sup> 24A	200	2,28

## YUVARLAK ERKEK TERMİNAL

Malzeme : Pirinç  
İzolasyon : PVC  
Voltaj : <600V  
Çalışma Sıcaklığı : Max. 75°

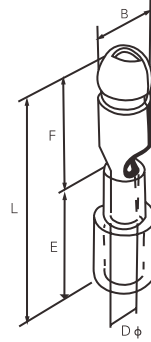

Ürün Kodu	Model Kodu	Kalınlık mm	Ebatlar					Renk	Kablo Kesiti	Kutu Adet	Fiyat (Adet/₺)
			B	F	DØ	E	L				
014 100 110510	YET-0,5-1	0.4	4.0	8.5	1.7	10.5	21.5	Kırmızı	0.5 ~1.5 mm <sup>2</sup> 10A	200	1,67
014 100 111525	YET-1,5-2,5	0.4	5.0	8.5	2.3	10.5	21.7	Mavi	1.5 ~2.5 mm <sup>2</sup> 15A	200	2,59
014 100 114060	YET-4-6	0.4	5.0	8.5	3.4	13.0	24.0	Sarı	4 ~6 mm <sup>2</sup> 24A	200	2,96

## İZOLELİ ERKEK - DIŞI TERMİNAL

Malzeme : Pirinç  
İzolasyon : PVC  
Voltaj : <600V  
Çalışma Sıcaklığı : Max. 75°

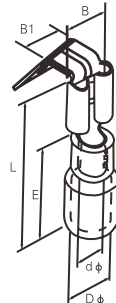

Ürün Kodu	Model Kodu	Soket Ölçüsü	Ebatlar						Renk	Kablo Kesiti	Kutu Adet	Fiyat (Adet/₺)
			B	B1	E	DØ	dØ	L				
014 100 130515	IEDT-0,5-1,5	0.8x6.35	6.6	6.35	10.0	3.8	1.7	22.5	Kırmızı	0.5 ~1.5 mm <sup>2</sup> 10A	100	3,70
014 100 131525	IEDT-1,5-2,5	0.8x6.35	6.6	6.35	10.0	4.3	2.3	22.5	Mavi	1.5 ~2.5 mm <sup>2</sup> 15A	100	3,70
014 100 134060	IEDT-4-6	0.8x6.35	6.6	6.35	13.0	5.7	3.4	24.0	Sarı	4 ~6 mm <sup>2</sup> 24A	100	4,44

## İZOLELİ TAM DIŞI TERMİNAL

Malzeme : Bakır  
İzolasyon : PVC  
Voltaj : <600V  
Çalışma Sıcaklığı : Max. 75°

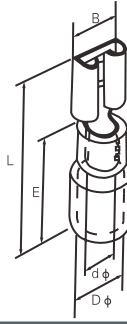

Ürün Kodu	Model Kodu	Soket Ölçüsü	Kalınlık (mm)	Ebatlar					Renk	Kablo Kesiti	Kutu Adet	Fiyat (Adet/₺)
				B	DØ	dØ	L	E				
014 100 080508	IDT-0,5-1/2.8	0.8x2.8	0.3	3.3	3.8	1.7	18.5	10.0	Kırmızı	0.5 ~1.5 mm <sup>2</sup> 10A	200	1,17
014 100 080509	IDT-0,5-1/4.8	0.8x4.75	0.35	5.0	3.8	1.7	19.0	10.0			200	1,54
014 100 080510	IDT-0,5-1/6.4	0.8x6.35	0.4	6.6	3.8	1.7	19.8	10.0			200	1,98
014 100 081523	IDT-1,5-2,5/2.8	0.8x2.8	0.3	3.3	4.3	2.3	18.5	10.0	Mavi	1.5 ~2.5 mm <sup>2</sup> 15A	200	1,54
014 100 081524	IDT-1,5-2,5/4.8	0.8x4.75	0.35	5.0	4.3	2.3	19.0	10.0			200	1,61
014 100 081525	IDT-1,5-2,5/6.4	0.8x6.35	0.4	6.6	4.3	2.3	19.0	10.0			200	2,01
014 100 084060	IDT-4-6	0.8x6.35	0.4	6.6	5.7	3.4	23.4	12.5	Sarı	4 ~6 mm <sup>2</sup> 24A	100	2,59

## TAM İZOLELİ FASTON EĞİK DIŞI TERMİNAL

Malzeme : Piriç  
İzolasyon : Nylon  
Voltaj : <600V  
Sıcaklık : 105° 400V

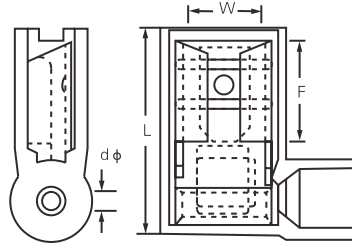

Ürün Kodu	Model Kodu	Soket Ölçüsü	Ebatlar				Renk	Kablo Kesiti	Kutu Adet	Fiyat (Adet/₺)
			W	F	L	dØ				
014 100 140515	TEDT-0,5-1,5	0.8x4.75	6.6	7.6	16.0	1.7	Kırmızı	0.5 ~1.5 mm <sup>2</sup> 10A	100	4,07
014 100 141525	TEDT-1,5-2,5	0.8x6.35	6.6	7.6	16.0	2.3	Mavi	1.5 ~2.5 mm <sup>2</sup> 15A	100	4,07
014 100 144060	TEDT-4-6	0.8x6.35	7.0	7.6	17.5	3.4	Sarı	4 ~6 mm <sup>2</sup> 24A	100	14,81

## POLYAMİD TAM İZOLELİ DIŞI TERMİNAL

Malzeme : Piriç  
İzolasyon : Nylon  
Voltaj : <600V  
Sıcaklık : 105° 400V

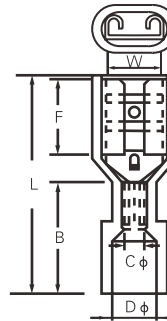

Ürün Kodu	Model Kodu	Soket Ölçüsü	Ebatlar						Renk	Kutu Adet	Fiyat (Adet/₺)
			W	F	L	B	DØ	CØ			
014 100 150510	TDTP-0,5-1/6.4	0.8x6.35	8.4	10.5	22.6	11.0	4.0	1.7	Kırmızı	200	3,70
014 100 151525	TDTP-1,5-2,5/6.4	0.8x6.35	8.4	10.5	22.6	11.0	4.5	2.3	Mavi	200	3,70
014 100 154060	TDTP-4-6	0.8x6.35	8.6	10.5	24.0	13.0	6.3	3.4	Sarı	100	4,44

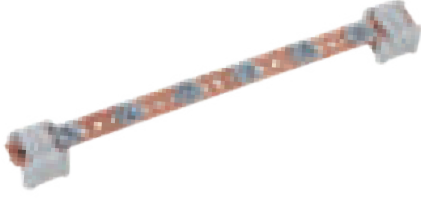

## TOPRAKLAMA BARASI VE MESNEDİ

Ürün Kodu	Ürün Adı	Adet	Fiyat (₺)
034 025 040000	TOPRAKLAMA BARASI 1,5 mm (31 VİDA)	40	935,75
034 025 100001	TOPRAKLAMA BARASI MESNEDİ	100	18,91

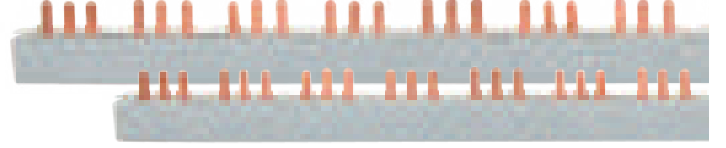

## TRİFAZE BARALAR

Ürün Kodu	Ürün Adı	Adet	Fiyat (₺)
034 025 040004	TRİFAZE MÜŞTEREK BARA İĞNE UÇLU 80A - 53 cm	24	777,39
034 025 040005	TRİFAZE MÜŞTEREK BARA İĞNE UÇLU 63A - 53 cm	24	662,22
034 025 040006	TRİFAZE MÜŞTEREK BARA İĞNE UÇLU 80A - 106 cm	24	1.554,78
034 025 040007	TRİFAZE MÜŞTEREK BARA İĞNE UÇLU 63A - 106 cm	24	1.324,44

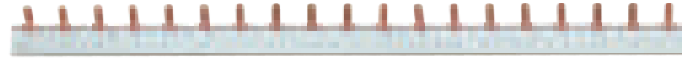

## MONOFAZE BARALAR

Ürün Kodu	Ürün Adı	Adet	Fiyat (₺)
034 025 040002	MONOFAZE MÜŞTEREK BARA İĞNE UÇLU 106 cm	50	569,62
034 025 040003	MONOFAZE MÜŞTEREK BARA İĞNE UÇLU 53 cm	50	292,59



## 250 MİKRON BAKIR KAPLAMA TOPRAKLAMA ÇUBUĞU

Ürün Kodu	Ürün Adı	Adet	Fiyat (₺)
091 025 011610	16 mm 1 mt TOPRAKLAMA ÇUBUĞU 250 MİKRON BAKIR KAPLAMA	10 ad.	744,63
091 025 011615	16 mm 1,5 mt TOPRAKLAMA ÇUBUĞU 250 MİKRON BAKIR KAPLAMA	10 ad.	1.067,30
091 025 012010	20 mm 1 mt TOPRAKLAMA ÇUBUĞU 250 MİKRON BAKIR KAPLAMA	5 ad.	1.067,30
091 025 012015	20 mm 1,5 mt TOPRAKLAMA ÇUBUĞU 250 MİKRON BAKIR KAPLAMA	5 ad.	1.563,71

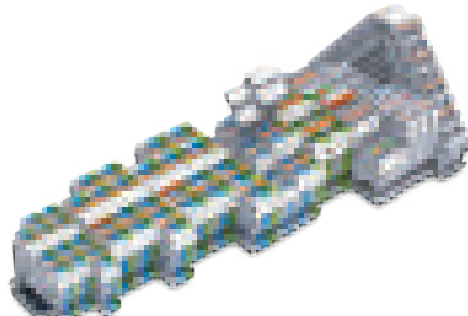

## RAYLAR

Ürün Kodu	Ürün Adı	Adet	Fiyat (₺)
001 025 020100 00 00	KLEMENS RAYI(1mt.)	25 mt.	173,65
001 025 000100 00 00	W OTOMAT RAYI(1M) (1mt. Fiyatı)	50 mt.	87,08
001 025 000200 00 00	W OTOMAT RAYI(2M) (1mt. Fiyatı)	50 mt.	87,08
001 025 000033 00 00	W OTOMAT RAYI (33 cm)	CE 50 mt.	29,69
001 025 900100 00 00	W OTOMAT RAYI(DELİKLİ)(1M)(1mt Fiyatı)	CE 50 mt.	78,80
001 025 900200 00 00	W OTOMAT RAYI(DELİKLİ)(2M)(1mt Fiyatı)	CE 50 mt.	78,80

## EKO KABLO PABUÇLARI

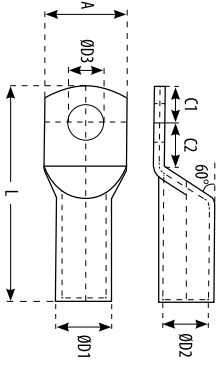

Ürün Kodu	Ürün Adı	Civata	D3	D2	D1	L	A	Kutu Adet	Fiyat (₺)
123 037 000016	16-06 EKO TİP KABLO PABUCU	M6	6,5	5,8	7,4	30	12	500	18,52
123 037 000025	25-08 EKO TİP KABLO PABUCU	M8	8,5	7	9,2	40	14	350	31,67
123 037 000035	35-08 EKO TİP KABLO PABUCU	M8	8,5	8,2	10,7	44	15,3	200	40,31
123 037 000050	50-10 EKO TİP KABLO PABUCU	M10	10,5	10,2	12,8	52	20	150	54,71
123 037 000070	70-10 EKO TİP KABLO PABUCU	M10	10,5	11,7	14,7	55	22	100	93,57
123 037 000095	95-12 EKO TİP KABLO PABUCU	M12	13	13,6	16,7	59	26	70	105,09
123 037 000120	120-12 EKO TİP KABLO PABUCU	M12	13	15,5	19	70	29	50	142,52
123 037 000150	150-12 EKO TİP KABLO PABUCU	M12	13	16,7	21	77	32	40	223,14
123 037 000185	185-16 EKO TİP KABLO PABUCU	M16	17	18,8	23	85	35	30	270,65
123 037 000240	240-16 EKO TİP KABLO PABUCU	M16	17	21,2	26	90	38,5	24	403,09

## STANDART KABLO PABUÇLARI

CE

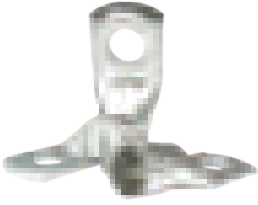

Ürün Kodu	Ürün Adı	Civata	D3	D2	D1	L	A	Kutu Adet	Fiyat (₺)
123 037 500010	10-05 STANDART TİP KABLO PABUCU	M5	5,2	4,7	6,5	27,5	10,5	800	19,62
123 037 500011	10-06 STANDART TİP KABLO PABUCU	M6	6,5	4,7	6,5	27,5	10,5	800	19,62
123 037 500012	10-08 STANDART TİP KABLO PABUCU	M8	8,5	4,7	6,5	27,5	10,5	800	19,62
123 037 500016	16-06 STANDART TİP KABLO PABUCU	M6	6,5	5,8	7,4	30	12	500	26,46
123 037 500017	16-08 STANDART TİP KABLO PABUCU	M8	8,5	5,8	7,8	30	12	500	26,46
123 037 500018	16-10 STANDART TİP KABLO PABUCU	M10	10,5	5,8	7,8	30	12	500	26,46
123 037 500024	25-06 STANDART TİP KABLO PABUCU	M6	6,5	7	9,2	40	14	350	43,58
123 037 500025	25-08 STANDART TİP KABLO PABUCU	M8	8,5	7	9,2	40	14	350	43,58
123 037 500026	25-10 STANDART TİP KABLO PABUCU	M10	10,5	7	9,5	40	14	350	43,58
123 037 500034	35-06 STANDART TİP KABLO PABUCU	M6	6,5	8,2	10,7	44	15,3	200	57,58
123 037 500035	35-08 STANDART TİP KABLO PABUCU	M8	8,5	8,2	10,7	44	15,3	200	57,58
123 037 500036	35-10 STANDART TİP KABLO PABUCU	M10	10,5	8,2	10,7	44	15,3	200	57,58
123 037 500037	35-12 STANDART TİP KABLO PABUCU	M12	13	8,2	10,7	44	15,3	200	57,58
123 037 500049	50-08 STANDART TİP KABLO PABUCU	M8	8,5	10,2	12,8	52	20	150	86,38
123 037 500050	50-10 STANDART TİP KABLO PABUCU	M10	10,5	10,2	12,8	52	20	150	86,38
123 037 500051	50-12 STANDART TİP KABLO PABUCU	M12	13	10,2	12,8	52	20	150	86,38
123 037 500069	70-08 STANDART TİP KABLO PABUCU	M8	8,5	11,7	14,7	55	22	100	115,17
123 037 500070	70-10 STANDART TİP KABLO PABUCU	M10	10,5	11,7	14,7	55	22	100	115,17
123 037 500071	70-12 STANDART TİP KABLO PABUCU	M12	13	11,7	14,7	55	22	100	115,17
123 037 500094	95-10 STANDART TİP KABLO PABUCU	M10	10,5	13,6	16,7	59	26	70	141,08
123 037 500095	95-12 STANDART TİP KABLO PABUCU	M12	13	13,6	16,7	59	26	70	141,08
123 037 500119	120-10 STANDART TİP KABLO PABUCU	M10	10,5	15,5	19	70	29	50	207,30
123 037 500120	120-12 STANDART TİP KABLO PABUCU	M12	13	15,5	19	70	29	50	207,30
123 037 500149	150-10 STANDART TİP KABLO PABUCU	M10	10,5	16,7	21	77	32	40	325,35
123 037 500150	150-12 STANDART TİP KABLO PABUCU	M12	13	16,7	21	77	32	40	325,35
123 037 500183	185-10 STANDART TİP KABLO PABUCU	M10	10,5	18,8	23	85	35	30	381,50
123 037 500184	185-12 STANDART TİP KABLO PABUCU	M12	13	18,8	23	85	35	30	381,50
123 037 500185	185-16 STANDART TİP KABLO PABUCU	M16	17	18,8	23	85	35	30	381,50
123 037 500238	240-10 STANDART TİP KABLO PABUCU	M10	10,5	21,2	26	90	38,5	24	515,38
123 037 500239	240-12 STANDART TİP KABLO PABUCU	M12	13	21,2	26	90	38,5	24	515,38
123 037 500240	240-16 STANDART TİP KABLO PABUCU	M16	17	21,2	26	90	38,5	24	515,38
123 037 500299	300-12 STANDART TİP KABLO PABUCU	M12	13	23,5	28,6	100	43	20	633,43
123 037 500300	300-16 STANDART TİP KABLO PABUCU	M16	17	23,5	28,6	100	43	20	633,43

## BORU TİP SIKMALI EK MUFLAR



Ürün Kodu	Ürün Adı	D2	D3	L	Kutu Adet	Fiyat (₺)
123 037 300016	16 mm² BORU TİP SIKMALI EK MUF	5,8	7,4	30	500	20,37
123 037 300025	25 mm² BORU TİP SIKMALI EK MUF	7,2	9,2	40	300	33,11
123 037 300035	35 mm² BORU TİP SIKMALI EK MUF	8,5	11	44	200	43,19
123 037 300050	50 mm² BORU TİP SIKMALI EK MUF	10	13	52	150	57,58
123 037 300070	70 mm² BORU TİP SIKMALI EK MUF	11,5	14,7	55	100	99,33
123 037 300095	95 mm² BORU TİP SIKMALI EK MUF	13,5	16,7	59	70	110,85
123 037 300120	120 mm² BORU TİP SIKMALI EK MUF	15,6	19	70	50	151,16
123 037 300150	150 mm² BORU TİP SIKMALI EK MUF	17	21	77	40	230,34
123 037 300185	185 mm² BORU TİP SIKMALI EK MUF	19	23	85	30	280,72
123 037 300240	240 mm² BORU TİP SIKMALI EK MUF	21	26	90	24	427,56

**KOLAY MONTAJ****YENİ****İSTER FİŞ OLSUN İSTER PRİZ!!  
DUVARDAN, MAKİNADAN  
SÖKMEYEN TEK TUŞLA DEĞİŞİM  
YAPABİLİRSİNİZ...****PATENTLİ**010 083 041516  
010 083 041532010 083 051516  
010 083 051532010 083 021516  
010 083 021532010 083 001516  
010 083 001532010 083 011516  
010 083 011532010 083 061516  
010 083 061532**MUTLUSAN CEE NORM SANAYİ TİPİ FİŞ - PRİZ GRUBU (TRİFAZE 5x16A - 5x32A)****CE**

Ürün Kodu	Ürün Adı	Kutu / Adet	Koli / Adet	Fiyat (₺)
010 083 041516	MUT-105 CEE NORM 5X16A DUVAR FİŞİ (TUŞ KİLİTLİ)	8	64	463,27
010 083 051516	MUT-106 CEE NORM 5X16A MAKİNE FİŞİ (TUŞ KİLİTLİ)	20	160	364,69
010 083 021516	MUT-107 CEE NORM 5X16A MAKİNE PRİZİ ( TUŞ KİLİTLİ)	20	160	410,14
010 083 001516	MUT-108 CEE NORM 5X16A DÜZ FİŞ ÜST MEKANİZMA	25	200	276,43
010 083 011516	MUT-109 CEE NORM 5X16A UZATMA PRİZİ ÜST MEKANİZMA	25	200	327,96
010 083 061516	MUT-116 CEE NORM 5X16A TUŞ KİLİTLİ FİŞ PRİZ APARATI	25	750	93,70
010 083 041532	MUT-205 CEE NORM 5X32A DUVAR FİŞİ (TUŞ KİLİTLİ)	8	64	592,68
010 083 051532	MUT-206 CEE NORM 5X32A MAKİNE FİŞİ (TUŞ KİLİTLİ)	20	160	488,76
010 083 021532	MUT-207 CEE NORM 5X32A MAKİNE PRİZİ ( TUŞ KİLİTLİ)	20	160	493,07
010 083 001532	MUT-208 CEE NORM 5X32A DÜZ FİŞ ÜST MEKANİZMA	25	200	374,81
010 083 011532	MUT-209 CEE NORM 5X32A UZATMA PRİZİ ÜST MEKANİZMA	25	200	398,24
010 083 061532	MUT-216 CEE NORM 5X32A TUŞ KİLİTLİ FİŞ PRİZ APARATI	25	750	93,70

010 083 041416  
010 083 041432010 083 051416  
010 083 051432010 083 021416  
010 083 021416010 083 001416  
010 083 001432010 083 011416  
010 083 011432010 083 061416  
010 083 061432**MUTLUSAN CEE NORM SANAYİ TİPİ FİŞ - PRİZ GRUBU (TRİFAZE 4x16A - 4x32A)****CE**

Ürün Kodu	Ürün Adı	Kutu / Adet	Koli / Adet	Fiyat (₺)
010 083 041416	MUT-405 CEE NORM 4X16A DUVAR FİŞİ (TUŞ KİLİTLİ)	8	64	481,78
010 083 051416	MUT-406 CEE NORM 4X16A MAKİNE FİŞİ (TUŞ KİLİTLİ)	20	160	340,00
010 083 021416	MUT-407 CEE NORM 4X16A MAKİNE PRİZİ ( TUŞ KİLİTLİ)	20	160	378,28
010 083 001416	MUT-408 CEE NORM 4X16A DÜZ FİŞ ÜST MEKANİZMA	30	240	230,14
010 083 011416	MUT-409 CEE NORM 4X16A UZATMA PRİZİ ÜST MEKANİZMA	30	240	311,10
010 083 061416	MUT-416 CEE NORM 4X16A TUŞ KİLİTLİ FİŞ PRİZ APARATI	30	900	93,70
010 083 041432	MUT-450 CEE NORM 4X32A DUVAR FİŞİ (TUŞ KİLİTLİ)	8	64	550,51
010 083 051432	MUT-460 CEE NORM 4X32A MAKİNE FİŞİ (TUŞ KİLİTLİ)	20	160	467,53
010 083 021416	MUT-470 CEE NORM 4X32A MAKİNE PRİZİ ( TUŞ KİLİTLİ)	20	160	448,37
010 083 001432	MUT-480 CEE NORM 4X32A DÜZ FİŞ ÜST MEKANİZMA	25	200	351,58
010 083 011432	MUT-490 CEE NORM 4X32A UZATMA PRİZİ ÜST MEKANİZMA	25	200	394,31
010 083 061432	MUT-432 CEE NORM 4X32A TUŞ KİLİTLİ FİŞ PRİZ APARATI	25	750	93,70

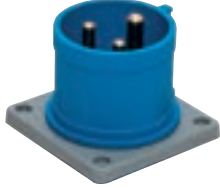
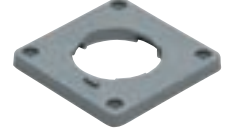
**YENİ**010 083 041316  
010 083 041332010 083 051316  
010 083 051332010 083 021316  
010 083 021332010 083 001316  
010 083 001332010 083 011316  
010 083 011332010 083 061316  
010 083 061332**MUTLUSAN CEE NORM SANAYİ TİPİ FİŞ - PRİZ GRUBU (MONOFAZE 3X16A - 3X32A) C E**

Ürün Kodu	Ürün Adı	Kutu / Adet	Koli / Adet	Fiyat (₺)
010 083 041316	MUT-305 CEE NORM 3X16A DUVAR FİŞİ (TUŞ KİLİTLİ)	8	64	406,11
010 083 051316	MUT-306 CEE NORM 3X16A MAKİNE FİŞİ (TUŞ KİLİTLİ)	20	160	276,24
010 083 021316	MUT-307 CEE NORM 3X16A MAKİNE PRİZİ ( TUŞ KİLİTLİ)	20	160	303,27
010 083 001316	MUT-308 CEE NORM 3X16A DÜZ FİŞ ÜST MEKANİZMA	30	240	169,42
010 083 011316	MUT-309 CEE NORM 3X16A UZATMA PRİZİ ÜST MEKANİZMA	30	240	195,14
010 083 061316	MUT-316 CEE NORM 3X16A TUŞ KİLİTLİ FİŞ PRİZ APARATI	30	750	93,70
010 083 041332	MUT-350 CEE NORM 3X32A DUVAR FİŞİ (TUŞ KİLİTLİ)	8	64	495,36
010 083 051332	MUT-360 CEE NORM 3X32A MAKİNE FİŞİ (TUŞ KİLİTLİ)	20	160	416,56
010 083 021332	MUT-370 CEE NORM 3X32A MAKİNE PRİZİ ( TUŞ KİLİTLİ)	20	160	391,03
010 083 001332	MUT-380 CEE NORM 3X32A DÜZ FİŞ ÜST MEKANİZMA	25	200	303,04
010 083 011332	MUT-390 CEE NORM 3X32A UZATMA PRİZİ ÜST MEKANİZMA	25	200	331,57
010 083 061332	MUT-332 CEE NORM 3X32A TUŞ KİLİTLİ FİŞ PRİZ APARATI	25	750	93,70

**YENİ**010 083 071563  
010 083 081563010 083 091563  
010 083 011563010 083 021563  
010 083 101563010 083 051563  
010 083 111563**MUTLUSAN CEE NORM SANAYİ TİPİ FİŞ - PRİZ GRUBU (TRİFAZE 5X63A - IP44) C E**

Ürün Kodu	Ürün Adı	Kutu / Adet	Koli / Adet	Fiyat (₺)
010 083 071563	MUT-501 CEE NORM 5X63A ERKEK FİŞ IP44	4	32	1.873,26
010 083 011563	MUT-502 CEE NORM 5X63A UZATMA PRİZİ IP44	4	32	2.491,70
010 083 021563	MUT-503 CEE NORM 5X63A MAKİNE PRİZİ IP44	6	48	1.944,96
010 083 051563	MUT-504 CEE NORM 5X63A MAKİNE FİŞİ IP44	6	48	1.944,96
010 083 081563	MUT-509 CEE NORM 5X63A ERKEK FİŞ PİLOTLU IP44	4	32	1.948,19
010 083 091563	MUT-510 CEE NORM 5X63A UZATMA PRİZİ PİLOTLU IP44	4	32	2.591,37
010 083 101563	MUT-511 CEE NORM 5X63A MAKİNE PRİZİ PİLOTLU IP44	6	48	2.022,76
010 083 111563	MUT-512 CEE NORM 5X63A MAKİNE FİŞİ PİLOTLU IP44	6	48	2.022,76

**YENİ**010 083 092563  
010 083 012563010 083 072563  
010 083 082563010 083 072563  
010 083 082563010 083 052563  
010 083 112563**MUTLUSAN CEE NORM SANAYİ TİPİ FİŞ - PRİZ GRUBU (TRİFAZE 5X63A - IP67) C E**

Ürün Kodu	Ürün Adı	Kutu / Adet	Koli / Adet	Fiyat (₺)
010 083 072563	MUT-505 CEE NORM 5X63A ERKEK FİŞ IP67	4	32	2.004,39
010 083 012563	MUT-506 CEE NORM 5X63A UZATMA PRİZİ IP67	4	32	2.666,12
010 083 022563	MUT-507 CEE NORM 5X63A MAKİNE PRİZİ IP67	6	48	2.081,11
010 083 052563	MUT-508 CEE NORM 5X63A MAKİNE FİŞİ IP67	6	48	2.081,11
010 083 082563	MUT-513 CEE NORM 5X63A ERKEK FİŞ PİLOTLU IP67	4	32	2.084,56
010 083 092563	MUT-514 CEE NORM 5X63A UZATMA PRİZİ PİLOTLU IP67	4	32	2.772,77
010 083 102563	MUT-515 CEE NORM 5X63A MAKİNE PRİZİ PİLOTLU IP67	6	48	2.164,35
010 083 112563	MUT-516 CEE NORM 5X63A MAKİNE FİŞİ PİLOTLU IP67	6	48	2.164,35

010 083 000516  
010 083 000532



010 083 010516  
010 083 010532



010 083 020516  
010 083 020532



010 083 030516  
010 083 030532

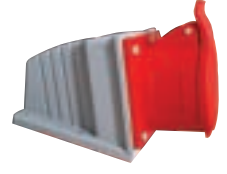

## MUTLUSAN CEE NORM SANAYİ TİPİ FİŞ - PRİZ GRUBU (TRİFAZE 5x16A - 5x32A)

CE

Ürün Kodu	Ürün Adı	Kutu / Adet	Koli / Adet	Fiyat (₺)
010 083 000516	MUT-101 CEE NORM 5x16 A DÜZ FİŞ	16	128	305,00
010 083 010516	MUT-102 CEE NORM 5x16 A UZATMA PRİZİ	15	120	390,65
010 083 020516	MUT-103 CEE NORM 5x16 A MAKİNE PRİZİ	20	160	441,25
010 083 030516	MUT-104 CEE NORM 5x16 A DUVAR PRİZİ	8	64	486,37
010 083 000532	MUT-201 CEE NORM 5x32 A DÜZ FİŞ	14	112	420,00
010 083 010532	MUT-202 CEE NORM 5x32 A UZATMA PRİZİ	12	96	469,60
010 083 020532	MUT-203 CEE NORM 5x32 A MAKİNE PRİZİ	14	112	430,00
010 083 030532	MUT-204 CEE NORM 5x32 A DUVAR PRİZİ	8	64	564,71

010 083 000416  
010 083 000432



010 083 010416  
010 083 010432



010 083 020416  
010 083 020432



010 083 030416  
010 083 030432

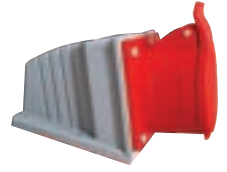

## MUTLUSAN CEE NORM SANAYİ TİPİ FİŞ - PRİZ GRUBU (TRİFAZE 4x16A - 4x32A)

CE

Ürün Kodu	Ürün Adı	Kutu / Adet	Koli / Adet	Fiyat (₺)
010 083 000416	MUT-401 CEE NORM 4/16 A DÜZ FİŞ	16	128	323,84
010 083 010416	MUT-402 CEE NORM 4/16 A UZATMA PRİZ	15	120	404,80
010 083 020416	MUT-403 CEE NORM 4/16 A MAKİNE PRİZİ (YENİ ÜRÜN)	20	160	360,29
010 083 030416	MUT-404 CEE NORM 4/16 A DUVAR PRİZİ (YENİ ÜRÜN)	8	64	458,87
010 083 000432	MUT-410 CEE NORM 4/32 A DÜZ FİŞ	14	112	445,28
010 083 010432	MUT-420 CEE NORM 4/32 A UZATMA PRİZ	12	96	488,01
010 083 020432	MUT-430 CEE NORM 4/32 A MAKİNE PRİZİ	14	112	427,10
010 083 030432	MUT-440 CEE NORM 4/32 A DUVAR PRİZİ	8	64	524,27

010 083 000316  
010 083 000332



010 083 010316  
010 083 010332



010 083 020316  
010 083 020332



010 083 030316  
010 083 030332



## MUTLUSAN CEE NORM SANAYİ TİPİ FİŞ - PRİZ GRUBU (TRİFAZE 3x16A - 3x32A)

CE

Ürün Kodu	Ürün Adı	Kutu / Adet	Koli / Adet	Fiyat (₺)
010 083 000316	MUT-301 CEE NORM 3/16 A DÜZ FİŞ	16	128	265,51
010 083 010316	MUT-302 CEE NORM 3/16 UZATMA PRİZ	15	120	308,44
010 083 020316	MUT-303 CEE NORM 3/16 MAKİNE PRİZİ	20	160	291,47
010 083 030316	MUT-304 CEE NORM 3/16 DUVAR PRİZİ	8	64	390,33
010 083 000332	MUT-310 CEE NORM 3/32 A DÜZ FİŞ	12	112	400,35
010 083 010332	MUT-320 CEE NORM 3/32 UZATMA PRİZ	12	96	429,14
010 083 020332	MUT-330 CEE NORM 3/32 MAKİNE PRİZİ	14	112	375,81
010 083 030332	MUT-340 CEE NORM 3/32 DUVAR PRİZİ	8	64	476,09



010 083 500298



010 083 500297



010 083 500299



010 083 502910

## MUTLUSAN SANAYİ TİPİ FİŞ - PRİZ GRUBU (MONOFAZE 1x16A) C €

Ürün Kodu	Ürün Adı	Kutu / Adet	Koli / Adet	Fiyat (₺)
010 083 500298	MUT-29/8 MONOFAZE TOP. PANO PRİZİ	40	320	71,90
010 083 500297	MUT-29/7 MONOFAZE DUVAR PRİZİ	30	240	134,20
010 083 500299	MUT-29/9 MONOFAZE MAKİNE PRİZİ	20	160	176,86
010 083 502910	MUT-29/10 MONOFAZE DUVAR PRİZİ	15	120	234,85

010 083 400064  
010 083 400318  
010 083 400074010 083 400063  
010 083 400319  
010 083 400073

## MUTLUSAN CEE NORM SANAYİ TİPİ FİŞ - PRİZ GRUBU (TRİFAZE 3x16A - 3x25A - 3x32A) C €

Ürün Kodu	Ürün Adı	Kutu / Adet	Koli / Adet	Fiyat (₺)
010 083 400064	MUT-64 3x16 TRİFAZE MAKİNE PRİZİ	20	160	281,59
010 083 400063	MUT-63 3x16 TRİFAZE DUVAR PRİZİ	12	96	315,39
010 083 400318	MUT-31/8 3x25 TRİFAZE MAKİNE PRİZİ	20	160	235,64
010 083 400319	MUT-31/9 3x25 TRİFAZE DUVAR PRİZİ	15	120	301,81
010 083 400074	MUT-74 3x32 TRİFAZE MAKİNE PRİZİ	20	160	346,43
010 083 400073	MUT-73 3x32 TRİFAZE DUVAR PRİZİ	12	96	405,95



010 083 300027



010 083 300028



010 083 300029



010 083 500296



010 083 500293



010 083 500294



010 083 501292



010 083 501293



010 083 500292

## MUTLUSAN KAUÇUK SANAYİ TİPİ FİŞ - PRİZ GRUBU (MONOFAZE 1x16A) C €

Ürün Kodu	Ürün Adı	Kutu / Adet	Koli / Adet	Fiyat (₺)
010 083 300027	MUT-27 1x16 A MONO. TOP. ERKEK FİŞ (EĞİK)	40	320	79,66
010 083 300028	MUT-28 1x16 A MONO. TOP. ERKEK FİŞ (DÜZ)	40	320	70,30
010 083 300029	MUT-29 1x16 A MONO. TOP. DIŞI FİŞ	25	200	128,67
010 083 500296	MUT-29/6 1x16 A MONO. TOP. DUVAR PRİZ	20	160	163,02
010 083 500293	MUT-29/3 1x16 A MONO. 3'LÜ GRUP PRİZ	12	96	226,00
010 083 500294	MUT-29/4 1x16 A MONO. 4'LÜ GRUP PRİZ	10	80	330,51
010 083 501292	MUT-29/2A 1x16 A MONO. 2'Lİ GRUP PRİZ ANAHTARLI	12	96	473,53
010 083 501293	MUT-29/3A 1x16 A MONO. 3'LÜ GRUP PRİZ ANAHTARLI	10	80	545,16
010 083 500292	MUT-29/2 1x16 A MONO. 2'Lİ GRUP PRİZ	14	112	203,09



010 083 400030 010 083 400031 010 083 600315 010 083 600311 010 083 600312 010 083 600313 010 083 600316 010 083 600317

## MUTLUSAN KAUÇUK SANAYİ TİPİ FİŞ - PRİZ GRUBU (TRİFAZE 3x25A) C €

Ürün Kodu	Ürün Adı	Kutu / Adet	Koli / Adet	Fiyat (₺)
010 083 400030	MUT-30 3x25 A TRİFAZE ERKEK FİŞ	25	200	163,02
010 083 400031	MUT-31 3x25 A TRİFAZE DIŞI İŞ (SEYYAR)	20	160	257,34
010 083 600315	MUT-31/5 3x25 A TRİFAZE DUVAR PRİZ	20	160	304,55
010 083 600311	MUT-31/1 1 TRİFAZE + 1 MONOFAZE GR. PRİZ	10	80	553,31
010 083 600312	MUT-31/2 TRİFAZE GRUP PRİZ -2'Lİ	10	80	613,37
010 083 600313	MUT-31/3 TRİFAZE GRUP PRİZ -3'LÜ	10	80	699,15
010 083 600316	MUT-31/6 2 TRİFAZE + 1 MONOFAZE GR.PRİZ	10	80	699,15
010 083 600317	MUT-31/7 1 TRİFAZE + 2 MONOFAZE GR.PRİZ	10	80	699,15



010 083 400060  
010 083 400070



010 083 400061  
010 083 400071



010 083 400062  
010 083 400072

## MUTLUSAN KAUÇUK SANAYİ TİPİ FİŞ - PRİZ GRUBU (TRİFAZE 3x16A / 3x32A) C €

Ürün Kodu	Ürün Adı	Kutu / Adet	Koli / Adet	Fiyat (₺)
010 083 400060	MUT-60 3x16 A TRİFAZE ERKEK FİŞ	30	240	283,31
010 083 400061	MUT-61 3x16 A TRİFAZE SEYYAR DIŞI FİŞ	25	200	346,60
010 083 400062	MUT-62 3x16 A TRİFAZE DUVAR PRİZİ	20	160	434,27
010 083 400070	MUT-70 3x32 A TRİFAZE ERKEK FİŞ	20	160	409,64
010 083 400071	MUT-71 3x32 A TRİFAZE SEYYAR DIŞI FİŞ	15	120	465,39
010 083 400072	MUT-72 3x32 A TRİFAZE DUVAR PRİZİ	20	160	613,37

## SİNTAŞ SANAYİ TİPİ FİŞ - PRİZLER

Ürün Kodu	Ürün Adı	Kutu Adet	Koli Adet	Fiyat (₺)
019 107 016250	16X25 A.4 KUTUPLU FİŞ-PRİZ	1	30	1.215,10
019 107 016252	16X25 A.4 KUTUPLU PRİZ	1	45	643,46
019 107 016251	16X25 A.4 KUTUPLU FİŞ	1	60	571,64
019 107 025400	25x40 A.4 KUTUPLU FİŞ-PRİZ	1	15	1.561,92
019 107 025402	25x40 A.4 KUTUPLU PRİZ	1	25	809,74
019 107 025401	25x40 A.4 KUTUPLU FİŞ	1	35	752,18
019 107 040630	40X63 A.4 KUTUPLU FİŞ-PRİZ	1	10	2.027,80
019 107 040632	40X63 A.4 KUTUPLU PRİZ	1	15	1.050,30
019 107 040631	40X63 A.4 KUTUPLU FİŞ	1	25	977,49
019 107 063100	63X100 A.4 KUTUPLU FİŞ-PRİZ	1	5	3.203,54
019 107 063102	63X100 A.4 KUTUPLU PRİZ	1	10	1.676,55
019 107 063101	63X100 A.4 KUTUPLU FİŞ	1	15	1.527,00



## SİNTAŞ SANAYİ TİPİ SEYYAR PRİZLER

Ürün Kodu	Ürün Adı	Kutu Adet	Koli Adet	Fiyat (₺)
019 107 016253	16X25 A.4 KUTUPLU SEYYAR PRİZ	1	45	643,46
019 107 025403	25x40 A.4 KUTUPLU SEYYAR PRİZ	1	25	809,74
019 107 040633	40X63 A.4 KUTUPLU SEYYAR PRİZ	1	15	1.050,30
019 107 063103	63X100 A.4 KUTUPLU SEYYAR PRİZ	1	10	1.676,55



## TERMOPLASTİK BUATLAR (GRİ-BEYAZ)

Grİ Kodu	Beyaz Kodu	Ürün Adı	Kutu Adet	Koli Adet	Grİ Fiyat (₺)	Beyaz Fiyat (₺)
-	001 046 000101 00 00	85x85 KARE ANTİGRON BUAT	10	300	-	37,04
001 046 078080 00 17	001 046 078080 00 00	80x80x48 (7 ÇIKIŞLI) TERMOPLASTİK BUAT	18	108	59,26	62,96
001 046 078585 00 17	001 046 078585 00 00	85x85x48 TERMOPLASTİK BUAT	18	108	55,56	59,26
001 046 070090 00 17	001 046 070090 00 00	Ø90 TERMOPLASTİK BUAT	18	108	100,00	107,41
001 046 071010 00 17	001 046 071010 00 00	110x110x74 (8 ÇIKIŞ) TERMOPLASTİK BUAT	10	40	107,41	129,63
001 046 071118 00 17	001 046 071118 00 00	110x180x77 (10 ÇIKIŞ) TERMOPLASTİK BUAT	5	30	166,67	214,81
001 046 071827 00 14	001 046 071827 00 00	180x270x100 (14 ÇIKIŞ) TERMOPLASTİK BUAT	2	8	462,96	518,52



## TERMOPLASTİK BUATLAR VE KOMBİNASYON KUTULARI

Ürün Kodu	Ürün Adı	Koli Adet	Fiyat (₺)
001 046 072698 00 44	138x226x98 TERMOPLASTİK BUAT (ŞEFFAF KAPAKLI)	8	444,44
001 046 072698 00 17	138x226x98 TERMOPLASTİK BUAT	8	388,89
001 046 076131 00 44	138x226x131 TERMOPLASTİK BUAT (ŞEFFAF KAPAKLI)	8	444,44
001 046 076131 00 17	138x226x131 TERMOPLASTİK BUAT	8	425,93
001 046 078226 00 17	138x226x127 KOMBİNASYON KUTUSU	8	481,48



## TERMOPLASTİK BUATLAR VE KOMBİNASYON KUTULARI

Ürün Kodu	Ürün Adı	Koli Adet	Fiyat (₺)
001 046 071199 00 44	225x311x99 TERMOPLASTİK BUAT (ŞEFFAF KAPAKLI)	4	685,19
001 046 071199 00 17	225x311x99 TERMOPLASTİK BUAT	4	555,56
001 046 071130 00 44	225x311x130 TERMOPLASTİK BUAT (ŞEFFAF KAPAKLI)	4	685,19
001 046 071130 00 17	225x311x130 TERMOPLASTİK BUAT	4	555,56
001 046 075311 00 17	225x311x132 KOMBİNASYON KUTUSU	4	777,78



001 046 098080 00 17



001 046 098585 00 17



001 046 090090 00 17



001 046 091010 00 17



001 046 091118 00 17



001 046 091827 00 17

## ALEV YAYMAYAN TERMOPLASTİK BUATLAR (GRİ-BEYAZ)



Grİ Kodu	Beyaz Kodu	Ürün Adı	Kutu Adet	Koli Adet	Grİ Fiyat (₺)	Beyaz Fiyat (₺)
001 046 098080 00 17	-	80x80x48 (7 ÇIKIŞLI) TERMOPLASTİK BUAT - ALEV YAYMAYAN	18	108	88,89	-
001 046 098585 00 17	001 046 098585 00 00	85x85x48 TERMOPLASTİK BUAT - ALEV YAYMAYAN	18	108	103,70	103,70
001 046 090090 00 17	001 046 090090 00 00	Ø90 TERMOPLASTİK BUAT - ALEV YAYMAYAN	18	108	96,30	96,30
001 046 091010 00 17	001 046 091010 00 00	110x110x74 (8 ÇIKIŞ) TERMOPLASTİK BUAT - ALEV YAYMAYAN	10	40	222,22	222,22
001 046 091118 00 17	001 046 091118 00 00	110x180x77 (10 ÇIKIŞ) TERMOPLASTİK BUAT - ALEV YAYMAYAN	5	30	388,89	388,89
001 046 091827 00 17	001 046 091827 00 00	180x270x100 (14 ÇIKIŞ) TERMOPLASTİK BUAT - ALEV YAYMAYAN	2	8	851,85	851,85



001 046 092698 00 44



001 046 092698 00 17



001 046 096131 00 44



001 046 096131 00 17



001 046 098226 00 17

## ALEV YAYMAYAN TERMOPLASTİK BUATLAR VE KOMBİNASYON KUTULARI

Ürün Kodu	Ürün Adı	Koli Adet	Fiyat (₺)
001 046 092698 00 44	138x226x98 TERMOPLASTİK BUAT (ŞEFFAF KAPAKLI) - ALEV YAYMAYAN	8	462,96
001 046 092698 00 17	138x226x98 TERMOPLASTİK BUAT - ALEV YAYMAYAN	8	481,48
001 046 096131 00 44	138x226x131 TERMOPLASTİK BUAT (ŞEFFAF KAPAKLI) - ALEV YAYMAYAN	8	500,00
001 046 096131 00 17	138x226x131 TERMOPLASTİK BUAT - ALEV YAYMAYAN	8	555,56
001 046 098226 00 17	138x226x127 KOMBİNASYON KUTUSU - ALEV YAYMAYAN	8	629,63



001 046 091199 00 44



001 046 091199 00 17



001 046 091130 00 44



001 046 091130 00 17



001 046 095311 00 17

## ALEV YAYMAYAN TERMOPLASTİK BUATLAR VE KOMBİNASYON KUTULARI

Ürün Kodu	Ürün Adı	Koli Adet	Fiyat (₺)
001 046 091199 00 44	225x311x99 TERMOPLASTİK BUAT (ŞEFFAF KAPAKLI) - ALEV YAYMAYAN	4	777,78
001 046 091199 00 17	225x311x99 TERMOPLASTİK BUAT - ALEV YAYMAYAN	4	777,78
001 046 091130 00 44	225x311x130 TERMOPLASTİK BUAT (ŞEFFAF KAPAKLI) - ALEV YAYMAYAN	4	814,81
001 046 091130 00 17	225x311x130 TERMOPLASTİK BUAT - ALEV YAYMAYAN	4	814,81
001 046 095311 00 17	225x311x132 KOMBİNASYON KUTUSU - ALEV YAYMAYAN	4	1.000,00



010 104 000180



010 104 000181



010 104 000182



010 104 000183

## KOMBİNASYON PANOLARI

Ürün Kodu	Ürün Adı	Koli Adet	Fiyat (₺)
010 104 000180	MK-325-2 3x25 A 1 ADET ÖN +1x16 A 2 ADET YAN	4	955,07
010 104 000181	MK-516-1 5x16 A 1 ADET ÖN + 1x16 A 1 ADET YAN	6	724,14
010 104 000182	MK-516-2 5x16 A 1 ADET ÖN + 1x16 A 2 ADET YAN	4	1.157,70
010 104 000183	MK-532-1 5x32 A 1 ADET ÖN + 1x16 A 1 ADET YAN	6	819,80



010 104 000184



010 104 000185



010 104 000186



010 104 000187

Ürün Kodu	Ürün Adı	Koli Adet	Fiyat (₺)
010 104 000184	MK-532-2 5x32 A 1 ADET ÖN + 1x16 A 2 ADET YAN	4	1.255,93
010 104 000185	MK-2325-2 3x25 A 2 ADET ÖN + 1x16 A 2 ADET YAN	4	1.488,91
010 104 000186	MK-2516-2 5x16A 2 ADET ÖN + 1x16 A 2 ADET YAN	4	1.893,67
010 104 000187	MK-2516-4 5x16 A 2 ADET ÖN + 1x16 A 4 ADET YAN	4	2.148,25



010 104 000188

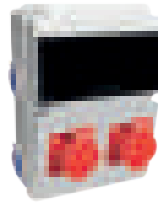

010 104 000189



010 104 000190



010 104 000191



010 104 000192

Ürün Kodu	Ürün Adı	Koli Adet	Fiyat (₺)
010 104 000188	MK-2532-2 5x32 A 2 ADET ÖN + 1x16 A 2 ADET YAN	4	2.086,54
010 104 000189	MK-2532-4 5x32 A 2 ADET ÖN + 1x16 A 4 ADET YAN	4	2.342,66
010 104 000190	MK-5164-4 5x16A 4 ADET ÖN + 1x16 A 4 ADET YAN	3	3.535,34
010 104 000191	MK-5324-4 5x32 A 4 ADET ÖN + 1x16 A 4 ADET YAN	3	3.922,09
010 104 000192	MK-51632-4 5x16A 2 ADET ÖN+5x32 A 2 AD. ÖN + 1x16 A 4 ADET YAN	3	3.727,69



010 104 000120



010 104 000121



010 104 000122



010 104 000123

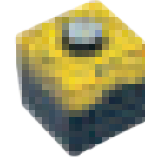

010 104 000124



010 104 000125



010 104 000126



010 104 000127



010 090 050009



010 104 000129



010 104 000130



010 104 000133

## KUTU MONTAJLI ÜRÜNLER

Ürün Kodu	Ürün Adı	Koli Adet	Fiyat (₺)
010 104 000120	MS-KK31 1'Lİ KUTULU START BUTONU (1NO)	18	226,69
010 104 000121	MS-KK42 1'Lİ KUTULU STOP BUTONU (1NC)	18	226,69
010 104 000122	MS-KK51 1'Lİ KUTULU START BUTONU (1NO)	18	226,69
010 104 000123	MS-BX71 1'Lİ KUTULU ALARM BUTONU (1NO)	18	236,99
010 104 000124	MS-BX81 1'Lİ KUTULU AYDINLATMA BUTONU (1NO)	18	236,99
010 104 000125	MS-KK7325 1'Lİ KUTULU İKİZ BUTONU (1NO+1NC)	18	321,52
010 104 000126	MS-KK4151 1'Lİ KUTULU İŞARETLİ İKİZ BUTONU (1NO+1NO)	18	331,83
010 104 000127	MS-KBZ 1'Lİ KUTULU KABİN ALTI İKAZ LAMBASI BUZZERLİ	18	389,50
010 090 050009	MS-BX542 1'Lİ KUTULU ACİL STOP BUTONU (1NC)	18	272,05
010 104 000129	MS-BX542E 1'Lİ KUTULU EMERGENCY STOP BUTONU (1NC)	18	280,31
010 104 000130	MS-BX542ASP 1'Lİ KUTULU MÜHÜRLÜ TİP KOR. ACİL STOP BUTONU (1NC)	12	429,84
010 104 000133	MS-KANT 1'Lİ KUTULU KAYICI RESET ANAHTARI	12	386,37



010 104 000105



010 104 000106



010 104 000107



010 104 000156

## EKO SERİSİ KUMANDA KUTULARI

Ürün Kodu	Ürün Adı	Koli Adet	Fiyat (₺)
010 104 000105	EKO101S EKO 1'Lİ BOŞ KUMANDA KUTUSU	90	51,85
010 104 000106	EKO201S EKO 1'Lİ KORUMALI BOŞ KUMANDA KUTUSU	50	55,56
010 104 000107	EKO301S EKO 1'Lİ ACİL STOP ETİ. KOR.YAZILI KUMANDA KUTUSU	50	207,41
010 104 000156	EKO401S EKO 1'Lİ ACİL STOPLU KUMANDA KUTUSU	50	207,41



010 091 01XX01



010 091 01XX02



010 091 01XX03



010 091 01XX04

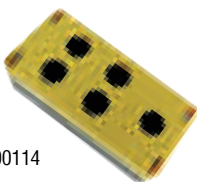

010 104 000114

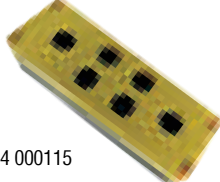

010 104 000115

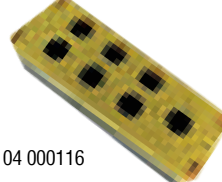

010 104 000116

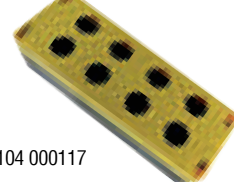

010 104 000117

## BOŞ KUMANDA KUTULARI

XX yerine Gri için 00, Sarı için 14 rakamını yazınız.

Ürün Kodu	Ürün Adı	Koli Adet	Fiyat (₺)
010 091 01XX01	1'Lİ ETANJ BUTON KUTUSU EUROBOX	24	97,96
010 091 01XX02	2'Lİ ETANJ BUTON KUTUSU EUROBOX	18	124,85
010 091 01XX03	3'LÜ ETANJ BUTON KUTUSU EUROBOX	12	167,42
010 091 01XX04	4'LÜ ETANJ BUTON KUTUSU EUROBOX	10	194,70
010 104 000114	SW-BX05SB 5'Lİ ETANJ BUTON KUTUSU EUROBOX	8	242,93
010 104 000115	SW-BX06SB 6'Lİ ETANJ BUTON KUTUSU EUROBOX	8	269,21
010 104 000116	SW-BX07SB 7'Lİ ETANJ BUTON KUTUSU EUROBOX	6	283,45
010 104 000117	SW-BX08SB 8'Lİ ETANJ BUTON KUTUSU EUROBOX	6	303,60

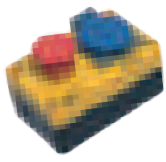

010 104 000134



010 104 000135



010 104 000136



010 104 000137



010 104 000138



010 104 000139



010 104 000140



010 104 000141



010 104 000142



010 104 000143



010 091 020001



010 104 000145



010 104 000146



010 104 000147



010 104 000148



010 104 000149

## ASANSÖR KUYU DİBİ SETLERİ VE KUMANDALARI

Ürün Kodu	Ürün Adı	Koli Adet	Fiyat (₺)
010 104 000134	MS-KYD02 2'Lİ ASANSÖR KUYU DİBİ BUTON 220V 16A TOPRAKLAMALI PRİZ + ACİL STOP BUTON	9	422,17
010 104 000135	MS-KYD03 ACİL STOP BUTON + SEÇİCİ BUTON (2NO) 220V 16A TOPRAKLAMALI PANO PRİZİ	6	641,53
010 104 000136	MS-KYD04 6'Lİ ACİL STOP BUTON +2 ADET OKLU BUTON (1NO) 1 İKİZ BUTON ( 2NO) 1 SEÇİCİ BUTON (2NO)	5	1.051,29
010 104 000137	MS-KYD05 ACİL STOP BUTON + 2 OKLU BUTON ORTAK OKLU (1NO) SEÇİCİ BUTON (2NO-1NC)	4	968,51
010 104 000138	MS-KYD06 ACİL STOP BUTON + 2 OKLU BUTON (2NO)1 ORTAK BUTON (1NO) ALARM BUTONU +SEÇİCİ BUTON (2NO-1NC)	2	1.051,29
010 104 000139	KY2-ALR KORUMALI ACİL STOP BUTON (1NC)NO KONTAKLI ALARM BUTONU KOMBİNASYON	10	422,17
010 104 000140	MS-KY5-24 KORUMALI ACİL STOP BUTON (1NC)LAMBA VAVİEN (1NO)24V KATTA LED (1NO) ALARM BUTON 16A KAPAKLI PRİZ	4	1.100,96
010 104 000141	MS-KY3 KORUMALI ACİL STOP BUTON + ALARM BUTON +16A KAPAKLI PRİZ KOMBİNASYON	5	612,56
010 104 000142	MS-KY3ES5012 KORUMALI ACİL STOP BUTON + ALARM + 9V PİLLİ 130 dB KOMBİNASYON	5	993,34
010 104 000143	MS-KY4ES5012 KORUMALI ACİL STOP BUTON + 9V PİLLİ 130 dB ALARM + 16A KAPAKLI PRİZ KOMBİNASYON	4	1.100,96
010 091 020001	MS-LV4 YUKARI (1NO) AŞAĞI (1NO) 0-1 REVİZYON (1NO) ACİL STOP BUTON (1NC) EL TERMİNALİ (EL KUMANDA)	6	778,12
010 104 000145	MS-LV5 YUKARI (1NO) ORTAK (1NO) AŞAĞI (1NO) 0-1 REVİZYON (1NO) ACİL STOP BUTON (1NC) 16A KAPAKLI PRİZ EL TERMİNALİ	4	1.100,96
010 104 000146	MS3BY-BG53P 3KADEME BY-PASSLI LAMBA BUTON (1NO) 24V KATTA LEDLİ REG.AÇMA (1NO) 16A KAPAKLI PRİZ KOMBİN.	4	1.506,57
010 104 000147	MS9-BX07 YUKARI (1NO) AŞAĞI (1NO) ORTAK (1NO) 24V KATTA LEDLİ KOR. ACİL STOP(1NC) ALARM (1NO) LAMBA (1NO)KOR. 0-1REV.(1NO)16A	1	1.665,37
010 104 000148	MS102-ED21 3BY 3KADEME BY-PASSLI REG.KİLİT (1NO) REG.AÇ(1NO) 24V KATTA LED FREN AÇMA (1NO) KOR.0-1SET RESET (1NO)	4	1.672,13
010 104 000149	MS201-ED21 REG.AÇ KAPA (2NO)24V KATTA LED LAMBA BUTON (1NO) FREN AÇMA1 (1NO) FREN AÇMA2(1NO) KORUMA SET RESET (2NO)	4	1.117,51



010 092 000001



010 092 000002



010 092 000003



010 092 000004



010 092 000005



010 092 000006

## VİNÇ KUTULARI

Ürün Kodu	Ürün Adı	Kutu Adet	Fiyat (₺)
010 092 000001	İKİLİ VİNÇ KUTUSU - TEK HIZLI	1	1.246,78
010 092 000002	ÜÇLÜ VİNÇ KUTUSU - TEK HIZLI	1	1.421,86
010 092 000003	DÖRTLÜ VİNÇ KUTUSU - TEK HIZLI	1	1.607,42
010 092 000004	BEŞLİ VİNÇ KUTUSU - TEK HIZLI	1	1.786,74
010 092 000005	ALTILİ VİNÇ KUTUSU - TEK HIZLI	1	2.178,29
010 092 000006	YEDİLİ VİNÇ KUTUSU - TEK HIZLI	1	2.357,56



010 104 000003



010 104 000004



010 104 000005



010 104 000006



010 104 000007



010 104 000008

## SWISS SERİSİ PLASTİK YAYLI BUTONLAR

Ürün Kodu	Ürün Adı	Kutu Adet	Fiyat (₺)
010 104 000003	SW-AA42 22 mm PLASTİK YAYLI BUTON - STOP	10	98,94
010 104 000004	SW-AA31 22 mm PLASTİK YAYLI BUTON - START	10	98,94
010 104 000005	SW-AA51 22 mm PLASTİK YAYLI BUTON - START	10	98,94
010 104 000006	SW-AA61 22 mm PLASTİK YAYLI BUTON - START	10	98,94
010 104 000007	SW-AA21 22 mm PLASTİK YAYLI BUTON - START	10	98,94
010 104 000008	SW-AA11 22 mm PLASTİK YAYLI BUTON - START	10	98,94



010 104 000009



010 104 000010



010 104 000011



010 104 000012



010 104 000013



010 104 000014

## SWISS SERİSİ PLASTİK YAYLI BUTONLAR

Ürün Kodu	Ürün Adı	Kutu Adet	Fiyat (₺)
010 104 000009	SW-AA4322 22 mm PLASTİK YAYLI BUTON - STOP	10	103,04
010 104 000010	SW-AA3361 22 mm PLASTİK YAYLI BUTON - START	10	103,04
010 104 000011	SW-AA3351 22 mm PLASTİK YAYLI BUTON - START	10	103,04
010 104 000012	SW-AA3341 22 mm PLASTİK YAYLI BUTON - START	10	103,04
010 104 000013	SW-AA3371 22 mm PLASTİK YAYLI BUTON - START	10	103,04
010 104 000014	SW-AA3381 22 mm PLASTİK YAYLI BUTON - START	10	103,04



010 104 000015



010 104 000016



010 104 000017



010 104 000018



010 104 000019



010 104 000020



010 104 000021



010 104 000022



010 104 000023



010 104 000024

## SWISS SERİSİ PLASTİK YAYLI İKİZ BUTONLAR

Ürün Kodu	Ürün Adı	Kutu Adet	Fiyat (₺)
010 104 000015	SW-AL7325 22 mm PLASTİK İKİZ BUTON (1NO+1NC)	10	201,98
010 104 000016	SW-AL7181 22 mm PLASTİK ALARM - LAMBA İKİZ BUTON (1NO+1NO)	10	222,59
010 104 000017	SW-AL4252 22 mm PLASTİK YUKARI AŞAĞI OKLU TERS YÖNLÜ İKİZ BUTON (1NO+1NO)	10	222,59
010 104 000018	SW-AL6171 22 mm PLASTİK ALARM ORTAK OKLU İKİZ BUTON (1NO+1NO)	10	222,59
010 104 000019	SW-AL6181 22 mm PLASTİK LAMBA ORTAK OKLU İKİZ BUTON (1NO+1NO)	10	222,59
010 104 000020	SW-AL7425 22 mm PLASTİK İŞARETLİ İKİZ BUTON (1NO+1NC)	10	222,59
010 104 000021	SW-AL7525 22 mm PLASTİK YAZILI İKİZ BUTON (1NO+1NC)	10	222,59
010 104 000022	SW-AL4151 22 mm PLASTİK YUKARI AŞAĞI OKLU BUTON (1NO+1NO)	10	222,59
010 104 000023	SW-AL7465L 22 mm PLASTİK İKİZ BUTON (1NO+1NC) LEDLİ 220V AC/DC	10	373,04
010 104 000024	SW-AL7465-24L 22 mm PLASTİK İKİZ BUTON (1NO+1NC) LEDLİ 24V AC/DC	10	373,04



010 104 000025



010 104 000026



010 104 000027



010 104 000028

## SWISS SERİSİ PLASTİK KALICI VE KAYICI MANDAL BUTONLAR

Ürün Kodu	Ürün Adı	Kutu Adet	Fiyat (₺)
010 104 000025	SW-AD21 PLASTİK KALICI 0 - 1 MANDAL BUTON (1NO)	10	115,44
010 104 000026	SW-AD41 PLASTİK KAYICI 0 - 1 MANDAL BUTON (1NO)	10	131,90
010 104 000027	SW-AD33 PLASTİK KALICI 2 - 0 - 1 MANDAL BUTON (1NO+1NO)	10	169,01
010 104 000028	SW-AD53 PLASTİK KAYICI 2 - 0 - 1 MANDAL BUTON (1NO+1NO)	10	183,42



010 104 000029



010 104 000030



010 104 000031



010 104 000032

## SWISS SERİSİ PLASTİK ANAHTARLI KALICI VE KAYICI MANDAL BUTONLAR

Ürün Kodu	Ürün Adı	Kutu Adet	Fiyat (₺)
010 104 000029	SW-AG21 PLASTİK KALICI 0 - 1 ANAHTARLI MANDAL BUTON (1NO)	10	309,12
010 104 000030	SW-AG41 PLASTİK KAYICI 0 - 1 ANAHTARLI MANDAL BUTON (1NO)	10	309,12
010 104 000031	SW-AG33 PLASTİK KALICI 2 - 0 - 1 ANAHTARLI MANDAL BUTON (1NO+1NO)	10	362,79
010 104 000032	SW-AG53 PLASTİK KAYICI 2 - 0 - 1 ANAHTARLI MANDAL BUTON (1NO+1NO)	10	362,79



010 104 000037



010 104 000038



010 104 000039

## SWISS SERİSİ PLASTİK KAYICI MANTAR BUTONLAR

Ürün Kodu	Ürün Adı	Kutu Adet	Fiyat (₺)
010 104 000037	SW-AC42 40MM KAFA PLASTİK KAYICI MANTAR BUTON (1NC)	10	135,43
010 104 000038	SW-AC31 40MM KAFA PLASTİK KAYICI MANTAR BUTON (1NO)	10	135,43
010 104 000039	SW-AC51 40MM KAFA PLASTİK KAYICI MANTAR BUTON (1NO)	10	135,43



010 104 000033



010 104 000034



010 104 000035



010 104 000036

## SWISS SERİSİ PLASTİK MANTAR ACİL STOP BUTONLAR

Ürün Kodu	Ürün Adı	Kutu Adet	Fiyat (₺)
010 104 000033	SW-AS142 40 mm KAFA PLASTİK ANAHTARLI MANTAR BUTON (1NC) ACİL STOP	10	346,14
010 104 000034	SW-AS542E 40 mm KAFA PLASTİK MANTAR BUTON (1NC) ACİL STOP ETİKETLİ	10	161,92
010 104 000035	SW-AS542 40 mm KAFA PLASTİK MANTAR BUTON (1NC) ACİL STOP	10	145,76
010 104 000036	SW-AS442 30 mm KAFA PLASTİK MANTAR BUTON (1NC) ACİL STOP	10	145,76



010 104 000040  
010 104 000041



010 104 000042  
010 104 000043



010 104 000044  
010 104 000045



010 104 000046  
010 104 000047

## SWISS SERİSİ PLASTİK LEDLİ, IŞIKLI, YAYLI BUTONLAR

Ürün Kodu	Ürün Adı	Kutu Adet	Fiyat (₺)
010 104 000040	SW-AW3475 22 mm LEDLİ IŞIKLI YAYLI BUTON STOP - 110-240V AC	10	283,36
010 104 000041	SW-AW3475 22 mm LEDLİ IŞIKLI YAYLI BUTON STOP - 10-30V DC	10	283,36
010 104 000042	SW-AW3375 22 mm LEDLİ IŞIKLI YAYLI BUTON START - 110-240V AC	10	283,36
010 104 000043	SW-AW3375-24 22 mm LEDLİ IŞIKLI YAYLI BUTON START - 10-30V DC	10	283,36
010 104 000044	SW-AW3575 22 mm LEDLİ IŞIKLI YAYLI BUTON START - 110-240V AC	10	283,36
010 104 000045	SW-AW3575-24 22 mm LEDLİ IŞIKLI YAYLI BUTON START - 10-30V DC	10	283,36
010 104 000046	SW-AW3675 22 mm LEDLİ IŞIKLI YAYLI BUTON START - 110-240V AC	10	283,36
010 104 000047	SW-AW3675-24 22 mm LEDLİ IŞIKLI YAYLI BUTON START - 10-30V DC	10	283,36



010 104 000054  
010 104 000057



010 104 000055  
010 104 000058



010 104 000056  
010 104 000059

## SWISS SERİSİ 1-0-2 PLASTİK LEDLİ, IŞIKLI KALICI MANDAL BUTONLAR

Ürün Kodu	Ürün Adı	Kutu Adet	Fiyat (₺)
010 104 000054	SW-AK323L 1-0-2 PLASTİK LEDLİ KALICI MANDAL BUTON (2NO) 110-240V AC	10	354,20
010 104 000055	SW-AK324L 1-0-2 PLASTİK LEDLİ KALICI MANDAL BUTON (2NC) 110-240V AC	10	354,20
010 104 000056	SW-AK325L 1-0-2 PLASTİK LEDLİ KALICI MANDAL BUTON (2NO) 110-240V AC	10	354,20
010 104 000057	SW-AK323-24L 1-0-2 PLASTİK LEDLİ KALICI MANDAL BUTON (2NO) 10-24V AC/DC	10	354,20
010 104 000058	SW-AK324-24L 1-0-2 PLASTİK LEDLİ KALICI MANDAL BUTON (2NC) 10-24V AC/DC	10	354,20
010 104 000059	SW-AK325-24L 1-0-2 PLASTİK LEDLİ KALICI MANDAL BUTON (2NO) 10-24V AC/DC	10	354,20



010 104 000048  
010 104 000051



010 104 000049  
010 104 000052



010 104 000050  
010 104 000053

## SWISS SERİSİ 0-1 PLASTİK LEDLİ, IŞIKLI KALICI MANDAL BUTONLAR

Ürün Kodu	Ürün Adı	Kutu Adet	Fiyat (₺)
010 104 000048	SW-AK123L 0-1 PLASTİK LEDLİ KALICI MANDAL BUTON (1NO) 110-240V AC	10	301,59
010 104 000049	SW-AK124L 0-1 PLASTİK LEDLİ KALICI MANDAL BUTON (1NC) 110-240V AC	10	301,59
010 104 000050	SW-AK125L 0-1 PLASTİK LEDLİ KALICI MANDAL BUTON (1NO) 110-240V AC	10	301,59
010 104 000051	SW-AK123-24L 0-1 PLASTİK LEDLİ KALICI MANDAL BUTON (1NO) 10-24V AC/DC	10	301,59
010 104 000052	SW-AK124-24L 0-1 PLASTİK LEDLİ KALICI MANDAL BUTON (1NC) 10-24V AC/DC	10	301,59
010 104 000053	SW-AK125-24L 0-1 PLASTİK LEDLİ KALICI MANDAL BUTON (1NO) 10-24V AC/DC	10	301,59



010 104 000001



010 104 000002

## POTANSİYOMETRE

Ürün Kodu	Ürün Adı	Kutu Adet	Fiyat (₺)
010 104 000001	MS22-5K POTANS 5K	15	526,24
010 104 000002	MS22-10K POTANS 10K	15	526,24



010 104 000064



010 104 000065



010 104 000066



010 104 000067



010 104 000068



010 104 000069

## SWISS SERİSİ METAL KAPLAMALI YAYLI BUTONLAR

Ürün Kodu	Ürün Adı	Kutu Adet	Fiyat (₺)
010 104 000064	SW-BA42 22 mm YAYLI BUTON STOP (1NC)	10	107,29
010 104 000065	SW-BA31 22 mm YAYLI BUTON START (1NO)	10	107,29
010 104 000066	SW-BA51 22 mm YAYLI BUTON START (1NO)	10	107,29
010 104 000067	SW-BA11 22 mm YAYLI BUTON START (1NO)	10	107,29
010 104 000068	SW-BA61 22 mm YAYLI BUTON START (1NO)	10	107,29
010 104 000069	SW-BA21 22 mm YAYLI BUTON START (1NO)	10	107,29



010 104 000071



010 104 000072



010 104 000073



010 104 000074



010 104 000075



010 104 000076

## SWISS SERİSİ METAL KAPLAMALI İŞARETLİ YAYLI BUTONLAR

Ürün Kodu	Ürün Adı	Kutu Adet	Fiyat (₺)
010 104 000071	SW-BA4322 22 mm İŞARETLİ YAYLI BUTON STOP (1NC)	10	117,41
010 104 000072	SW-BA3351 22 mm İŞARETLİ YAYLI BUTON START (1NO)	10	117,41
010 104 000073	SW-BA3341 22 mm İŞARETLİ YAYLI BUTON START (1NO)	10	117,41
010 104 000074	SW-BA3361 22 mm İŞARETLİ YAYLI BUTON START (1NO)	10	117,41
010 104 000075	SW-BA3371 22 mm İŞARETLİ YAYLI BUTON START (1NO)	10	117,41
010 104 000076	SW-BA3381 22 mm İŞARETLİ YAYLI BUTON START (1NO)	10	117,41



010 104 000077



010 104 000078



010 104 000079

## SWISS SERİSİ METAL KAPLAMALI İKİZ BUTONLAR

Ürün Kodu	Ürün Adı	Kutu Adet	Fiyat (₺)
010 104 000077	SW-BL7325 22 mm PLASTİK İKİZ BUTON (1NO+1NC)	10	195,18
010 104 000078	SW-BL7425 22 mm PLASTİK İKİZ BUTON (1NO+1NC)	10	240,87
010 104 000079	SW-BL7525 22 mm PLASTİK YAZILI İKİZ BUTON (1NO+1NC)	10	240,87



010 104 000080

010 104 000081

010 104 000082

010 104 000083

010 104 000084

010 104 000085

010 104 000086

## SWISS SERİSİ METAL KAPLAMALI İKİZ BUTONLAR

Ürün Kodu	Ürün Adı	Kutu Adet	Fiyat (₺)
010 104 000080	SW-BL4151 22 mm PLASTİK YUKARI AŞAĞI OKLU İKİZ BUTON (1NO+1NO)	10	240,87
010 104 000081	SW-BL4252 22 mm PLASTİK YUKARI AŞAĞI TERS YÖN OKLU İKİZ BUTON (1NO+1NO)	10	240,87
010 104 000082	SW-BL6171 22 mm PLASTİK ALARM ORTAK OKLU İKİZ BUTON (1NO+1NO)	10	240,87
010 104 000083	SW-BL7181 22 mm PLASTİK ALARM - LAMBA İKİZ BUTON (1NO+1NO)	10	240,87
010 104 000084	SW-BL6181 22 mm PLASTİK LAMBA ORTAK OKLU İKİZ BUTON (1NO+1NO)	10	240,87
010 104 000085	SW-BL7465L 22 mm PLASTİK İKİZ BUTON LEDLİ (220V AC)	10	404,80
010 104 000086	SW-BL7465L-24L 22 mm PLASTİK İKİZ BUTON LEDLİ (24V AC/DC)	10	404,80



010 104 000087



010 104 000088



010 104 000089



010 104 000090

## SWISS SERİSİ METAL KAPLAMALI KALICI VE KAYICI MANDAL BUTONLAR

Ürün Kodu	Ürün Adı	Kutu Adet	Fiyat (₺)
010 104 000087	SW-BD21 0-1 KALICI MANDAL BUTON (1NO)	10	125,52
010 104 000088	SW-BD41 0-1 KAYICI MANDAL BUTON (1NO)	10	141,68
010 104 000089	SW-BD33 1-0-2 KALICI MANDAL BUTON (1NO+1NO)	10	182,25
010 104 000090	SW-BD53 1-0-2 KAYICI MANDAL BUTON (1NO+1NO)	10	200,39



010 104 000168



010 104 000169



010 104 000170



010 104 000171



010 104 000172



010 104 000173

## SWISS SERİSİ METAL KAPLAMALI 0-1 LEDLİ KALICI BUTONLAR

Ürün Kodu	Ürün Adı	Kutu Adet	Fiyat (₺)
010 104 000168	SW-BK123L 0-1 LEDLİ İŞIKLI KALICI MANDAL BUTON (1NO) 110-240V AC	10	309,69
010 104 000169	SW-BK124L 0-1 LEDLİ İŞIKLI KALICI MANDAL BUTON (1NC) 110-240V AC	10	309,69
010 104 000170	SW-BK125L 0-1 LEDLİ İŞIKLI KALICI MANDAL BUTON (1NO) 110-240V AC	10	309,69
010 104 000171	SW-BK123L-24L 0-1 LEDLİ İŞIKLI KALICI MANDAL BUTON (1NO) 10-30V AC/DC	10	309,69
010 104 000172	SW-BK124L-24L 0-1 LEDLİ İŞIKLI KALICI MANDAL BUTON (1NC) 10-30V AC/DC	10	309,69
010 104 000173	SW-BK125L-24L 0-1 LEDLİ İŞIKLI KALICI MANDAL BUTON (1NC) 10-30V AC/DC	10	309,69



010 104 000160



010 104 000162



010 104 000164



010 104 000166



010 104 000161



010 104 000163



010 104 000165



010 104 000167

## SWISS SERİSİ METAL KAPLAMALI LEDLİ İŞIKLI YAYLI BUTONLAR

Ürün Kodu	Ürün Adı	Kutu Adet	Fiyat (₺)
010 104 000160	BW-3475 22 mm LEDLİ İŞIKLI YAYLI BUTON STOP 110-240V AC	10	289,45
010 104 000161	BW-3475-24L 22 mm LEDLİ İŞIKLI YAYLI BUTON STOP 10-30V AC/DC	10	289,45
010 104 000162	BW-3375 22 mm LEDLİ İŞIKLI YAYLI BUTON START 110-240V AC	10	289,45
010 104 000163	BW-3375-24L 22 mm LEDLİ İŞIKLI YAYLI BUTON START 10-30V AC/DC	10	289,45
010 104 000164	BW-3575 22 mm LEDLİ İŞIKLI YAYLI BUTON START 110-240V AC	10	289,45
010 104 000165	BW-3575-24L 22 mm LEDLİ İŞIKLI YAYLI BUTON START 10-30V AC/DC	10	289,45
010 104 000166	BW-3675 22 mm LEDLİ İŞIKLI YAYLI BUTON START 110-240V AC	10	289,45
010 104 000167	BW-3675-24L 22 mm LEDLİ İŞIKLI YAYLI BUTON START 10-30V AC/DC	10	289,45



010 104 000174



010 104 000175



010 104 000176



010 104 000177



010 104 000178



010 104 000179

## SWISS SERİSİ METAL KAPLAMALI 0-1-2 LEDLİ KALICI MANDAL BUTONLAR

Ürün Kodu	Ürün Adı	Kutu Adet	Fiyat (₺)
010 104 000174	BK-323L 1-0-2 PLASTİK LEDLİ KALICI MANDAL BUTON (2NO) 110-240V AC	10	362,31
010 104 000175	BK-324L 1-0-2 PLASTİK LEDLİ KALICI MANDAL BUTON (2NC) 110-240V AC	10	362,31
010 104 000176	BK-325L 1-0-2 PLASTİK LEDLİ KALICI MANDAL BUTON (2NO) 110-240V AC	10	362,31
010 104 000177	BK-323-24L 1-0-2 PLASTİK LEDLİ KALICI MANDAL BUTON (2NO) 10-24V AC/DC	10	362,31
010 104 000178	BK-324-24L 1-0-2 PLASTİK LEDLİ KALICI MANDAL BUTON (2NC) 10-24V AC/DC	10	362,31
010 104 000179	BK-325-24L 1-0-2 PLASTİK LEDLİ KALICI MANDAL BUTON (2NO) 10-24V AC/DC	10	362,31

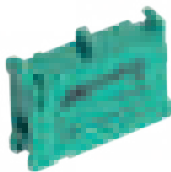

010 104 000060

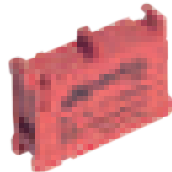

010 104 000061

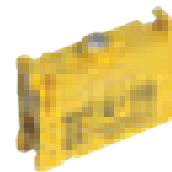

010 104 000062

## YAYLI BUTON YEDEK KONTAKLARI VE KILIFI

Ürün Kodu	Ürün Adı	Kutu Adet	Fiyat (₺)
010 104 000060	SW-BE101 KONTAK BLOK (NO)	50	54,68
010 104 000061	SW-BE102 KONTAK BLOK (NC)	50	54,68
010 104 000062	SW-BE103 İŞIK SOKETİ 10/30 110-240V AC	50	186,24



010 104 000091



010 104 000092

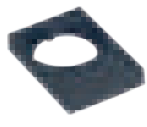

010 104 000093



010 093 000002



010 093 000001



010 093 000099

## BUTON AKSESUARLARI

Ürün Kodu	Ürün Adı	Kutu Adet	Fiyat (₺)
010 104 000091	SW-BR1 PLASTİK BUTON ROZETİ 26x8 CAMLI	100	36,45
010 104 000092	SW-BR2 PLASTİK BUTON ROZETİ 26x18 CAMLI	100	40,48
010 104 000093	SW-SİE-R PLASTİK BUTON ROZETİ 27x12 CAMSIZ	100	32,42
010 093 000002	SW-BRY PLASTİK YAZILI BUTON ROZETİ	100	20,24
010 093 000001	SW-AP2 BUTON KORUMA KILIFI (YAYLI BUTONLAR İÇİN)	50	42,32
010 104 000099	SW-AP4 IP67 İKİZ BUTON KORUMA KILIFI (YAYLI BUTONLAR İÇİN)	50	42,32



010 104 000213



YENİ

010 104 000214  
010 104 000215  
010 104 000216  
010 104 000217



010 090 050008



010 104 000101



010 104 000096



010 093 000003



010 104 000104

## ACİL STOP ETİKETLERİ

Ürün Kodu	Ürün Adı	Kutu Adet	Fiyat (₺)
010 104 000213	SW-ASP TAM KAPAKLI MÜHÜRLÜ ACİL STOP KORUMA KAPAĞI	10	74,96
010 104 000214	SW-SY60L SÜREKLİ YANAR LEDLİ ETİKET 220V	25	468,52
010 104 000215	SW-SY60-24 SÜREKLİ YANAR LEDLİ ETİKET 24V	25	468,52
010 104 000216	SW-FY60L FLAŞ YANAR LEDLİ ETİKET 220V	25	562,22
010 104 000217	SW-FY60L-24 FLAŞ YANAR LEDLİ ETİKET 24V	25	562,22
010 104 000096	SW-ER60EN-Y Ø60 mm PLASTİK EMERGENCY ROZETİ (İNCE TİP) LAZER BASKI	50	34,44
010 093 000003	ACİL DURDURMA ETİKETİ	50	32,37
010 090 050008	SW-AKKM EMNİYET BASMA DÜĞMESİ MUHAFAZA	50	28,34
010 104 000101	SW-AKK ACİL STOP KORUMA KAPAĞI	50	44,44
010 104 000104	SW-MKKY MANDAL BUTON KORUMA KAPAĞI	50	29,63



999 999 995000



999 999 995001



999 999 995002



## VOLTMETRE VE AMPERMETRE

Ürün Kodu	Ürün Adı	Koli Adet	Fiyat (₺)
999 999 995000	22 mm VOLTMETRE PLASTİK LED GÖSTERGELİ 20-500V AC	10	266,67
999 999 995001	22 mm AMPERMETRE (AKIM TRAFOLU) PLS. LED GÖS. 1A-100A AC / 60-380V AC	10	537,04
999 999 995002	22 mm VOLT + AMPERMETRE (AKIM TRAFOLU) PLS. LED GÖS. 20-500V AC / 1A-100A AC	10	740,74



010 090 01XX01



010 090 01XX05  
010 090 01XX06  
010 090 01XX07



010 090 01XX04  
010 090 07XX02

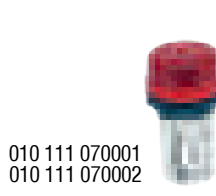

010 111 070001  
010 111 070002

### XX KARŞILIĞI OLAN RENK KODLARI

○	●	●	●	●
Beyaz 00	Mavi 13	Sarı 14	Yeşil 15	Kırmızı 16

## MUTLUSAN SİNYAL VE KUMANDA BUTONLARI

Ürün Kodu	Ürün Adı	Kutu Adet	Fiyat (₺)
010 090 01XX01	10 mm KABLOLU SİNYAL ARMATÜRÜ	100	26,71
010 090 010005	14 mm SİNYAL ARMATÜRÜ - 12V	50	37,25
010 090 010006	14 mm SİNYAL ARMATÜRÜ - 24V	50	37,25
010 090 01XX07	14 mm SİNYAL ARMATÜRÜ - 220V	50	37,25
010 090 01XX04	22 mm SİNYAL ARMATÜRÜ LEDLİ - 220V	24	51,74
010 090 07XX02	22 mm SİNYAL ARMATÜRÜ LEDLİ - 24V	24	49,67
010 111 070001	BUZZER LEDLİ - 220V	24	219,78
010 111 070002	BUZZER LEDLİ - 24V	24	219,78



MB-QH



MB-BH..1



MB-BH..2



MB-BH..3

T5  
Ø50



T7  
Ø70  
multi



T6

## BORULU KORNALAR, IŞIKLI KOLONLAR, İKAZ LAMBALARI

Ürün Kodu	Ürün Adı	Çalışma Şekli	Besleme Gerilimi	Adet	Fiyat (\$)
<b>BH SERİSİ MULTİ 105 dB 1-2-3 KATLI BORULU KORNALAR</b>					
129 087 000401	M-BH-241	MULTİ	24 V DC	1	66,40 \$
129 087 000403	M-BH-221	MULTİ	220V AC	1	74,70 \$
129 087 000405	M-BH-242	MULTİ	24 V DC	1	99,60 \$
129 087 000407	M-BH-222	MULTİ	220V AC	1	116,20 \$
129 087 000409	M-BH-243	MULTİ	24 V DC	1	116,20 \$
129 087 000411	M-BH-223	MULTİ	220V AC	1	132,80 \$
<b>QH SERİSİ MULTİ 105 dB 1-2-3 KATLI BORULU KORNALAR</b>					
129 087 000400	M-QH-241	MULTİ	24 V DC	1	66,40 \$
129 087 000402	M-QH-221	MULTİ	220V AC	1	74,70 \$
129 087 000404	M-QH-242	MULTİ	24 V DC	1	99,60 \$
129 087 000406	M-QH-222	MULTİ	220V AC	1	116,20 \$
129 087 000408	M-QH-243	MULTİ	24 V DC	1	116,20 \$
129 087 000410	M-QH-223	MULTİ	220V AC	1	132,80 \$

Ürün Kodu	Ürün Adı	Çalışma Şekli	Besleme Gerilimi	Adet	Fiyat (\$)
<b>T5 SERİSİ 1 KATLI IŞIKLI KOLONLAR</b>					
129 087 000278	S-T5-241	SABİT	24 V DC	1	41,50 \$
129 087 000279	S-T5-221	SABİT	220V AC	1	49,80 \$
129 087 000281	F-T5-241	FLAŞÖRLÜ	24V DC	1	64,80 \$
129 087 000282	F-T5-221	FLAŞÖRLÜ	220V AC	1	69,70 \$
129 087 000284	Ç-T5-241	ÇAKAR	24 V DC	1	64,80 \$
129 087 000285	Ç-T5-221	ÇAKAR	220V AC	1	69,70 \$
129 087 000287	SB-T5-241	SABİT+BUZZER	24V DC	1	68,10 \$
129 087 000288	SB-T5-221	SABİT+BUZZER	220V AC	1	76,40 \$
129 087 000290	FB-T5-241	FLAŞÖRLÜ+BUZZER	24V DC	1	81,40 \$
129 087 000291	FB-T5-221	FLAŞÖRLÜ+BUZZER	220V AC	1	89,70 \$
<b>T5 SERİSİ 2 KATLI IŞIKLI KOLONLAR</b>					
129 087 000296	S-T5-242	SABİT	24 V DC	1	59,80 \$
129 087 000297	S-T5-222	SABİT	220V AC	1	63,10 \$
129 087 000299	F-T5-242	FLAŞÖRLÜ	24V DC	1	71,40 \$
129 087 000300	F-T5-222	FLAŞÖRLÜ	220V AC	1	84,70 \$
129 087 000302	SB-T5-242	SABİT+BUZZER	24 V DC	1	78,00 \$
129 087 000303	SB-T5-222	SABİT+BUZZER	220V AC	1	86,30 \$
129 087 000305	FB-T5-242	FLAŞÖRLÜ+BUZZER	24V DC	1	88,00 \$
129 087 000306	FB-T5-222	FLAŞÖRLÜ+BUZZER	220V AC	1	96,30 \$
<b>T5 SERİSİ 3 KATLI IŞIKLI KOLONLAR</b>					
129 087 000308	S-T5-243	SABİT	24 V DC	1	63,10 \$
129 087 000309	S-T5-223	SABİT	220V AC	1	68,10 \$
129 087 000311	F-T5-243	FLAŞÖRLÜ	24V DC	1	81,40 \$
129 087 000312	F-T5-223	FLAŞÖRLÜ	220V AC	1	89,70 \$
129 087 000314	SB-T5-243	SABİT+BUZZER	24 V DC	1	98,00 \$
129 087 000315	SB-T5-223	SABİT+BUZZER	220V AC	1	106,30 \$
129 087 000317	FB-T5-243	FLAŞÖRLÜ+BUZZER	24V DC	1	106,30 \$
129 087 000318	FB-T5-223	FLAŞÖRLÜ+BUZZER	220V AC	1	116,20 \$
<b>T7 SERİSİ 1 KATLI IŞIKLI KOLONLAR</b>					
129 087 000651	M-T7-241	MULTİ	24 V DC	1	41,50 \$
129 087 000652	M-T7-221	MULTİ	220V AC	1	49,90 \$
129 087 000653	MB-T7-241	MULTİ + BUZZER	24V DC	1	49,80 \$
129 087 000654	MB-T7-221	MULTİ + BUZZER	220V AC	1	58,10 \$
<b>T7 SERİSİ 2 KATLI IŞIKLI KOLONLAR</b>					
129 087 000655	M-T7-242	MULTİ	24 V DC	1	56,50 \$
129 087 000656	M-T7-222	MULTİ	220V AC	1	66,50 \$
129 087 000657	MB-T7-242	MULTİ + BUZZER	24V DC	1	66,40 \$
129 087 000658	MB-T7-222	MULTİ + BUZZER	220V AC	1	74,70 \$
<b>T7 SERİSİ 3 KATLI IŞIKLI KOLONLAR</b>					
129 087 000659	M-T7-243	MULTİ	24 V DC	1	66,50 \$
129 087 000660	M-T7-223	MULTİ	220V AC	1	86,20 \$
129 087 000661	MB-T7-243	MULTİ + BUZZER	24V DC	1	74,70 \$
129 087 000662	MB-T7-223	MULTİ + BUZZER	220V AC	1	83,00 \$

Ürün Kodu	Çap (Ø)	Ürün Adı	Çalışma Şekli	Besleme Gerilimi	Adet	Fiyat (\$)
<b>T6 SERİSİ MULTİ FONKSİYON İKAZ LAMBALARI</b>						
129 087 000441	Ø60	M-T6-24K	MULTİ	24 V DC	1	33,20 \$
129 087 000442		M-T6-22K	MULTİ	220V AC	1	47,50 \$
129 087 000443		MB-T6-24K	MULTİ + BUZZER	24V DC	1	41,50 \$
129 087 000444		MB-T6-22K	MULTİ + BUZZER	220V AC	1	49,80 \$

IŞIKLI KOLONLARDA KIRMIZI SABİT RENKTİR. DİĞER RENKLER SİPARİŞLE YAPILIP, İADESİ YOKTUR.

**ŞALT GRUBU**  
Otomatik Sigorta

# Evinizin Kalkanı



### **Mutlusan Plastik Elektrik San ve Tic. A.Ş.**

İkitelli Org.San. Bölgesi Mahallesi Enkoop Cad.  
No:7 Başakşehir-İstanbul  
Tel : +90 (212) 485 05 44 (PBX)  
Faks : +90 (212) 485 10 12

### **Karaköy Şube**

Okçumusa Cad. Güneşhan İş Hanı No : 24/10  
Karaköy- İstanbul  
Tel : +90 (212) 237 06 02 (PBX)  
Fax: +90 (212) 237 77 47

### **Perpa Şube**

Perpa Tic. Merkezi A Blok Kat: 2  
No: 9-009 Okmeydanı - İstanbul  
Tel : +90 (212) 320 05 78 (PBX)  
Fax: +90 (212) 320 05 81

[mutlusan.com.tr](http://mutlusan.com.tr)

